

---

# Electrical Infrastructure

North America



**PANDUIT**<sup>®</sup>

infrastructure for a connected world

# Best Seller and Featured Products for Industrial Construction, MRO and OEM



Proven **QUALITY**  
Performance



Subject Matter  
**EXPERTISE**



Customer-driven  
**INNOVATION**



Partner with a company committed to meeting the daily challenges you face. Panduit offers a full solution of **BEST SELLER** and **FEATURED PRODUCTS** – from cable ties to power connectors, terminals to identification – Panduit products are engineered for all aspects of designing, installing and maintaining infrastructures within heavy-duty industrial environments. Our robust partner ecosystem, global staff, unmatched service and support make Panduit a valuable and trusted partner.

For the complete offering, please contact your local Panduit representative or visit us at [www.panduit.com](http://www.panduit.com)



# Applications and Market Solutions

## Commercial Construction

Panduit offers a broad product portfolio across two trusted brands to support contractor needs for the toughest electrical construction applications and environments. The Panduit brand products are engineered for best-in-class safety, reliability and productivity for maximum contractor value and the Stronghold brand products are designed to be reliable, convenient and economical. From power and grounding connectors, to electrical supplies, pre-fab components and wire management products, Panduit is the partner of choice for leading electrical contractors.

## Food and Beverage

Food and beverage manufacturers are faced with countless product safety, quality and manufacturing challenges. Maximizing productivity while reducing downtime requires a robust integrated electrical infrastructure that can deliver optimum productivity, reliability and profitability.

## Oil and Gas

The world's appetite for energy grows every day, and oil and gas are still the best options for meeting global demand. Faced with the need to explore in challenging locations, integrate new oil sands and shale capabilities, meet updated safety protocols, and identify new technologies to handle remote environments, energy producers are looking for partners who can help them keep up with changing business conditions and goals.

## Renewable Energy

Panduit has the proven renewable energy solutions, along with global supply chain and engineering guidance you need to design and build best-in-class solar and wind environments. Our renewable energy electrical infrastructure solutions play a vital role in the world top renewable energy production facilities. Panduit rigorously tests all solar and wind equipment to ensure outstanding performance in high wind and high vibration operations, under intense UV exposure, in extreme temperatures, and in the presence of corrosive agents.

## Safety















As facilities become more complex than ever, managers need solutions that simplify operations and reduce risk. Utilizing a Prevention through Design approach, Panduit is pioneering new ways to protect customer assets, people, and places with revolutionary solutions that unlock efficiency and enable organizations to achieve more.

## Transportation

Electrical connectors and wire management products are critical components in vehicles that transport goods or people, from light-rail cars to heavy duty truck and buses for commercial, military, and aerospace industries. Panduit transportation solutions can help you overcome challenges around evolving safety standards and certifications requirements, complex design specifications, and the rigors of harsh environments. Our products withstand vibration, shock, abrasion, and temperature extremes and are tested and certified to meet global standards.



# Table of Contents

 Product Showcase .....	3-6
 Abrasion Protection .....	7-20
 Cable Cleats .....	21-26
 Cable Ties.....	27-64
 Cable Tie Accessories.....	65-84
 Cable Tie Tools .....	85-90
 Identification Products.....	91-108
 Power Connectors.....	109-128
 Grounding Connectors .....	129-142
 Safety Solutions .....	143-150
 Stainless Steel Ties .....	151-158
 Terminals.....	159-182
 Wiring Duct, Surface Raceway, and Wire Basket....	183-214
 Part Number Index.....	215-220





## The Safe Way to Protect Employees and Equipment

The VeriSafe™ 2.0 Absence of Voltage Tester simplifies the voltage testing process. With the push of a button, workers can quickly determine voltage status and see an active indication when the absence of voltage is confirmed. [See Pages 144–146](#)

## Label Faster, Smarter and Easier

PXE™ Mobile Printers combine world-class printing technology from Epson with industry-leading performance and field-tested durability from Panduit to help you do your job smarter, faster and easier. [See Pages 92–93](#)



Product Showcase

Abrasion Protection

Cable Cleats

Cable Ties

Cable Tie Accessories

Cable Tie Tools

Identification Products

Power Connectors

Grounding Connectors

Safety Solutions

Stainless Steel Ties

Terminals

Wiring Duct

Part Number Index

Product Showcase

Abrasion Protection

Cable Cleats

Cable Ties

Cable Tie Accessories

Cable Tie Tools

Identification Products

Power Connectors

Grounding Connectors

Safety Solutions

Stainless Steel Ties

Terminals

Wiring Duct

Part Number Index



### Increase Productivity and Stay Organized with Cable Entry Systems

Cable Entry Systems offer a safe, organized method to transition both terminated and unterminated cables through enclosures and electrical equipment, providing strain relief while maintaining IP/NEMA ingress sealing ratings. [See Pages 18-20](#)

### Contain Cables During a Short Circuit Event

Cable cleat solutions ensure cables remain contained in the event of a short circuit fault to minimize disruption and damage to personnel and property. Uniquely engineered for ease of installation and available in a range of applications and harsh environments, our cable cleats meet the needs of any project while providing on-the-job productivity, reliability, and safety. [See Pages 21-26](#)







## Produce High Quality, High Volume Terminations

The CA9 Ezair™ Applicator is a crimping device that delivers high-volume, high-quality terminations and is compatible with all Panduit Reel Smart™ products. The universal baseplate is compatible with most commercially available bench-top presses and automatic wire processing machines. Quick change die sets allow for fast product change over and reduction in set-up time. [See Pages 166-167](#)

## Limit Contact Resistance and Protect Against Corrosion

Tin-Plated Copper Compression Lugs, one-hole, standard barrel, narrow-tongue, have color-coded barrels marked with Panduit and specified competitor die index numbers for proper crimp die selection. Each Panduit lug is made from high-strength electrolytic copper to provide premium performance. UL Listed and CSA Certified to 35 KV and temperature rated to 90°C. [See Pages 110-120](#)



Product Showcase

Abrasion Protection

Cable Cleats

Cable Ties

Cable Tie Accessories

Cable Tie Tools

Identification Products

Power Connectors

Grounding Connectors

Safety Solutions

Stainless Steel Ties

Terminals

Wiring Duct

Part Number Index

Product Showcase

Abrasion Protection

Cable Cleats

Cable Ties

Cable Tie Accessories

Cable Tie Tools

Identification Products

Power Connectors

Grounding Connectors

Safety Solutions

Stainless Steel Ties

Terminals

Wiring Duct

Part Number Index



## Improve Productivity and Increase Profitability with the PAT 4.0 System

When it comes to high-volume harnessing, assembly, fastening, and packaging applications, productivity is critical. To remain competitive, manufacturers are faced with the constant struggle to increase throughput, reduce lead times, and meet customer expectations. The Panduit PAT 4.0 Automatic Cable Tie Installation System addresses these challenges by introducing a series of next generation features and functionality to transform wire bundling and assembly as you know it. [See Pages 88-90](#)

## Consistent Cable Tie Performance in Solar Applications

Weather Resistant Nylon 612 cable ties have a high resistance to Ultraviolet light and corrosive elements making it ideal for harsh external applications. It's designed to satisfy the needs of solar applications, while delivering consistent performance and reliability in today's market. The robust material properties of nylon 612 also ensure continuous stable hold in position for cable or pipe work guaranteeing a wide application use including high wind and high vibration. [See Page 38](#)





# ABRASION PROTECTION

---

Pan-Wrap™ Split Harness Wrap .....	8
Spiral Wrap .....	8-9
Grommet Edging .....	10
Corrugated Loom Tubing .....	11
Braided Expandable Sleeving – Polyethylene Terephthalate (PET).....	12
Braided Expandable Sleeving – Flame Retardant Polyethylene Terephthalate.....	12
Fray Resistant Braided Expandable Sleeving .....	13
Pan-Wrap™ Braided Sleeving.....	13
Tinned Copper Braided Sleeving.....	13
Heavy Duty Nylon Braided Sleeving.....	14
Insulating Fiberglass Tubing .....	14
Duct Seal – Sealing Compounds .....	14
Heat Shrink End Caps .....	14
HSTT Heat Shrink 4 Foot Pieces and Reels.....	15
HSTTA Heat Shrink 4 Foot Pieces.....	16
HSTTRA Heat Shrink 4 Foot Pieces .....	16
HST Thick Wall Polyolefin Heat Shrink.....	17
Cable Entry Systems.....	18-20

### Pan-Wrap™ Split Harness Wrap

- Patented slot pattern provides improved flexibility and abrasion protection in any application
- Innovative design maintains uniform bundle protection in dynamic applications
- Considerably reduces installation time
- Large overlap accommodates a wide range of bundle diameters
- Packaged on a reel for easy handling and dispensing of product
- UL File: E141152
- Voltage rating: 600 V



Part Number	Material*	Color	Length Per Reel		Max Bundle Diameter		Min. Bundle Diameter‡		Temperature Range	Nominal I.D.		Std. Pkg. Qty.*					
			Ft.	m	In.	mm	In.	mm		In.	mm						
PW50F-T	Polyethylene	Natural	200	61.0	0.55	14.0	0.43	10.9	-40°F – 122°F (-40°C – 50°C)	0.50	12.7	1					
PW50F-T20		Black															
PW75F-C		Natural	100	30.5	0.81	20.6	0.55	14.0		0.75	19.1						
PW75F-C20		Black															
PW100F-C20		Natural								1.13	28.6		0.81	20.6	1.00	25.4	
PW100F-C		Yellow															
PW150F-L		Natural	50	15.2	1.63	41.3	1.13	28.6		1.50	38.1						
PW100FR-C20Y		Flame Retardant Polyethylene	Black	100	30.5	1.13	28.6	0.81		20.6	1.00		25.4				
PW50FR-T20Y	Natural		200	61	0.55	14	0.43	10.9	0.50	12.7							
PW75FR-C20Y	Black		100	30.5	0.81	20.6	0.55	14	0.75	19.1							
PW75FR-CY	Natural										1.13		28.6	0.81	20.6	1.00	25.4
PW100FR-CY	Black																

‡Diameter can be further reduced with the use of cable ties  
 \*Order number of reels required

### Spiral Wrap

- Installation tool supplied in each package
- Available in multiple materials
- Reusable
- UL File: E141152
- Voltage Rating: 600 V



Part Number	Material*	Color	Length Per Reel‡		Bundle Diameter Range		Outside Diameter		Temperature Range	Wall Thickness		Std. Pkg. Qty.
			Ft.	m	In.	mm	In.	mm		In.	mm	
T25F-C	Polyethylene	Natural	100	30.5	3/16 – 2	4.8 – 50.8	0.25	6.4	-40°F – 122°F (-40°C – 50°C)	0.040	1.02	1
T25F-C3Y		Orange										
T25F-C10		White										
T25F-M			1000	304.8								
T38F-C		Natural	100	30.5	5/16 – 3	7.9 – 76.2	0.38	9.5		0.055	1.40	
T38F-TL			250	76.2								
T50F-C			100	30.5	3/8 – 4	9.5 – 101.6	0.50	12.7		0.060	1.52	
T50F-C4Y		Yellow										
T50F-TL		Natural										
T50F-TL4Y		Yellow	250	76.2								

\*Flame retardant products are manufactured from a material that is rated UL 94V-0

‡Reel packaging may contain splices. Contact Panduit Customer Service for further information

(continued on next page)



### Spiral Wrap (continued)

Part Number	Material*	Color	Length Per Reel‡		Bundle Diameter Range		Outside Diameter		Temperature Range	Wall Thickness		Std. Pkg. Qty.		
			Ft.	m	In.	mm	In.	mm		In.	mm			
T62F-C	Polyethylene	Natural	100	30.5	1/2 – 4 1/2	12.7 – 114.3	0.62	15.9	-40°F – 122°F (-40°C – 50°C)	0.062	1.57	1		
T75F-C					5/8 – 5	15.9 – 127.0	0.75	19.1		0.065	1.65			
T100F-C					7/8 – 6	22.2 – 152.4	1.00	25.4		0.070	1.78			
T25F-C0	Weather Resistant Polyethylene		100	30.5	3/16 – 2	4.8 – 50.8	0.25	6.4		0.040	1.02			
T38F-C0					5/16 – 3	7.9 – 76.2	0.38	9.5		0.055	1.40			
T50F-X0	Polyethylene		10	3.1										
<b>BEST SELLER</b> T50F-C0	Weather Resistant Polyethylene	Black	100	30.5	3/8 – 4	9.5 – 101.6	0.50	12.7	-40°F – 239°F (-40°C – 115°C)	0.060	1.52	1		
T50F-TL0														
T75F-C0					5/8 – 5	15.9 – 127.0	0.75	19.1		0.065	1.65			
T100F-C0					7/8 – 6	22.2 – 152.4	1.00	25.4		0.070	1.78			
T38P-C0					5/16 – 3	7.9 – 76.2	0.38	9.5						
T50P-C0			100	30.5	3/8 – 4	9.5 – 101.6	0.50	12.7		0.030	0.76			
T100P-C0					7/8 – 6	22.2 – 152.4	1.00	25.4						
T25R-CY	Fire Resistant Polyethylene	Natural	250	76.2	3/16 – 2	4.8 – 50.8	0.25	6.4	-40°F – 122°F (-40°C – 50°C)	0.040	1.02			
T50R-CY					3/8 – 4	9.5 – 101.6	0.50	12.7		0.055	1.40			
T50R-TLY										0.060	1.52			
T12FR-CY	Flame Retardant Polyethylene	Natural	100	30.5	1/16 – 1/2	1.6 – 12.7	0.12	3.2	-4°F – 122°F (-20°C – 50°C)	0.030	0.76	1		
T25FR-CY					3/16 – 2	4.8 – 50.8	0.25	6.4		0.040	1.02			
T25FR-C20Y						4.8 – 50.9	0.25	6.4						
T38FR-C20Y		5/16 – 3	7.9 – 76.2	0.38	9.5	0.055	1.40							
T50FR-CY		Natural												
T50FR-C20Y		Black	3/8 – 4	9.5 – 101.6	0.50	12.7	0.060	1.52						
T50FR-TLY		250	76.2											
T75FR-CY	Natural													
T75FR-C20Y	Black	5/8 – 5	15.9 – 127.0	0.75	19.1	0.065	1.65							
T25N-C	Nylon 6.6	Natural	250	76.2	3/16 – 2	4.8 – 50.8	0.25	6.4		0.023	0.58			
T38N-TL					5/16 – 3	5/16 – 3	0.38	9.5		0.030	0.76			
T25N-C0	Weather Resistant Nylon 6.6	Black	100	30.5	3/16 – 2	4.8 – 50.8	0.25	6.4	-40°F – 149°F (-40°C – 65°C)	0.023	0.58	1		
T38N-C0					5/16 – 3	7.9 – 76.2	0.38	9.5		0.030	0.76			
T50N-TL0			250	76.2	3/8 – 4	9.5 – 101.6	0.50	12.7						
T62N-C0			100	30.5	1/2 – 4 1/2	12.7 – 114.3	0.62	15.9		0.035	0.89			
T100N-C0					7/8 – 6	22.2 – 152.4	1.00	25.4		0.040	1.02			
T12T-C	TFE^	Natural	50	15.2	1/16 – 1/2	1.6 – 12.7	0.12	3.2	-454°F – 356°F (-270°C – 180°C)	0.020	0.51	1		
<b>BEST SELLER</b> T25T-L					3/16 – 2	4.8 – 50.8	0.25	6.4						
T38T-L			5/16 – 3	7.9 – 76.2		0.38	9.5							
<b>BEST SELLER</b> T50T-Q			3/8 – 4	9.5 – 101.6	0.50	12.7								
T62T-Q				1/2 – 4 1/2	12.7 – 114.3	0.62	15.9							
T75T-X			10	3.1	5/8 – 5	15.9 – 127.0	0.75	19.1						

\*Flame retardant products are manufactured from a material that is rated UL 94V-0  
 ‡Reel packaging may contain splices. Contact Panduit Customer Service for further information  
 ^TFE is Polytetrafluorethylene material

- Product Showcase
- Abrasion Protection
- Cable Cleats
- Cable Ties
- Cable Tie Accessories
- Cable Tie Tools
- Identification Products
- Power Connectors
- Grounding Connectors
- Safety Solutions
- Stainless Steel Ties
- Terminals
- Wiring Duct
- Part Number Index

### Grommet Edging

- Use slotted product on irregularly shaped and round panel holes
- Provided in 0.030 inches (0.8mm) thick material making it highly flexible
- Adhesive Lined Grommet Edging: 3 year shelf life

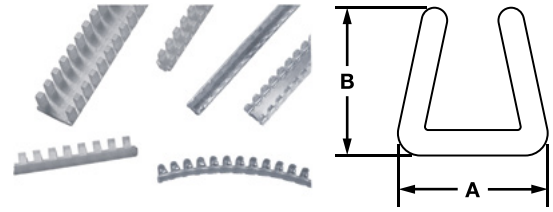
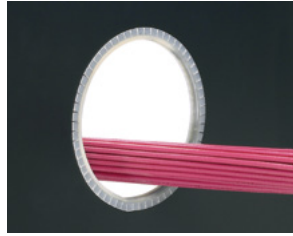

Part Number	Width A		Height B		Panel Thickness Range		Material	Color	Temperature Range	Std. Pkg. Qty.
	In.	mm	In.	mm	In.	mm				
<b>Slotted</b>										
<b>GEE62F-C</b>	0.13	3.3	0.16	4.1	0.036 – 0.062	0.9 – 1.6	Polyethylene	Natural*	-40°F – 122°F (-40°C – 50°C)	1
<b>GEE99F-C</b>	0.17	4.3	0.19	4.7	0.062 – 0.099	1.6 – 2.5				
<b>GEE144F-C</b>	0.21	5.4	0.22	5.6	0.099 – 0.144	2.5 – 3.7				
<b>GEE189F-C</b>	0.297	7.55	0.301	7.65	0.144 – 0.189	3.66 – 4.8		Weather Resistant Polyethylene		
<b>GEE189F-C0</b>										

### Slotted Adhesive Lined

<b>BEST SELLER</b>												
<b>GEE62F-A-C</b>	0.13	3.3	0.16	4.1	0.036 – 0.062	0.9 – 1.6	Polyethylene	Natural*	-40°F – 122°F (-40°C – 50°C)	1		
<b>GEE62F-A-C0</b>							Weather Resistant Polyethylene	Black				
<b>BEST SELLER</b>												
<b>GEE99F-A-C</b>	0.17	4.3	0.19	4.7	0.062 – 0.099	1.6 – 2.5	Polyethylene	Natural*				
<b>GEE99F-A-C0</b>							Weather Resistant Polyethylene	Black				
<b>BEST SELLER</b>												
<b>GEE144F-A-C</b>	0.21	5.4	0.22	5.6	0.099 – 0.144	2.5 – 3.7	Polyethylene	Natural*				
<b>GEE144F-A-C0</b>							Weather Resistant Polyethylene	Black				
<b>GEE189F-A-C</b>	0.297	7.55	0.301	7.65	0.144 – 0.189	3.66 – 4.8	Polyethylene	Natural*				
<b>GEE189F-A-C0</b>							Weather Resistant Polyethylene	Black				

### Solid Adhesive Lined – Use on straight edges only

<b>BEST SELLER</b>										
<b>GES62F-A-C</b>	0.13	3.3	0.16	4.1	0.036 – 0.062	0.9 – 1.6	Polyethylene	Natural*	-40°F – 122°F (-40°C – 50°C)	1
<b>GES62F-A-C0</b>							Weather Resistant Polyethylene	Black		
<b>GES99F-A-C</b>	0.17	4.3	0.19	4.7	0.062 – 0.099	1.6 – 2.5	Polyethylene	Natural*		
<b>GES99F-A-C0</b>							Weather Resistant Polyethylene	Black		
<b>GES189F-A-C</b>	0.297	7.55	0.301	7.65	0.144 – 0.189	3.66 – 4.8	Polyethylene	Natural*		
<b>GES189F-A-C0</b>							Weather Resistant Polyethylene	Black		

### National Aerospace Standard\*\* NAMS21266 in 12.75" Lengths

<b>GE85-C</b>	0.18	4.5	0.16	3.9	0.052 – 0.085	1.3 – 2.2	Nylon 6.6	Natural*	-40°F – 149°F (-40°C – 65°C)	100
<b>GE128-C</b>	0.22	5.6		3.9	0.085 – 0.128	2.2 – 3.3				
<b>GE192-L</b>	0.33	8.3	0.23	5.8	0.128 – 0.192	3.3 – 4.9				
<b>GE255-L</b>	0.39	9.8	0.24	6.1	0.192 – 0.255	4.9 – 6.5				50

\*Natural color can range from opaque to clear

### Corrugated Loom Tubing

- Provides abrasion resistance as well as light crush and impact resistance
- UV Resistant Corrugated Loom Tubing can be used in outdoor applications



Part Number	Material	Color	Length Per Reel*		Inside Diameter		Outside Diameter		Temperature Range	Std. Pkg. Qty.
			Ft.	m	In.	mm	In.	mm		
<b>UV Resistant Polypropylene Slit Wall</b>										
CLT75PUV-0	Polypropylene	Black	4265	1300	0.811	20.60	0.984	25.00	40°F – 185°F (-40°C – 85°C)	1
CLT100PUV-0			2329	710	1.142	29.01	1.358	34.49		
CLT150PUV-0			1542	470	1.417	36.00	1.673	42.49		
CLT188PUV-0			885	270	1.890	48.01	2.146	54.51		

### Polyethylene Slit Wall

<b>BEST SELLER</b>	Polyethylene	Black	100	30.5	0.28	7.2	0.40	10.1	-40°F – 122°F (-40°C – 50°C)	1
CLT25F-C20					0.39	10.0	0.52	13.3		
CLT38F-C20					0.51	13.0	0.65	16.6		
CLT50F-C3										
CLT50F-C4		Black	100	30.5	0.66	16.9	0.85	21.1		
<b>BEST SELLER</b>										
CLT62F-C20		Orange	100	30.5	0.77	19.5	0.94	23.9		
CLT75F-C3										
CLT75F-C4		Yellow	100	30.5	0.91	23.2	1.10	28.0		
<b>BEST SELLER</b>										
CLT75F-2M20		Black	50	15.2	1.28	32.5	1.54	39.0		
<b>BEST SELLER</b>										
CLT100F-C4		Orange	10	3.1	1.58	40.0	1.85	47.0		
<b>BEST SELLER</b>										
CLT125F-L20		Yellow*	500	152.4	1.51	38.4	1.76	44.6		
<b>BEST SELLER</b>										
CLT150F-X4F		Black	10	3.1	1.58	40.0	1.85	47.0		
CLT150F-D4F										
CLT150F-X20		Black	200	61.0	1.58	40.0	1.85	47.0		
CLT150F-T20										
CLT188F-C20	100	30.5	1.85	47.0	2.19	55.7				

### Polyethylene Solid Wall

CLTS25F-C	Polyethylene	Black	100	30.5	0.28	7.2	0.40	10.1	-40°F – 122°F (-40°C – 50°C)	1
-----------	--------------	-------	-----	------	------	-----	------	------	---------------------------------	---

### Nylon Slit

CLT25N-C630	Heat Stabilized Nylon 6	Black	100	30.5	0.28	7.2	0.40	10.1	-40°F – 230°F (-40°C – 110°C)	1
CLT38N-C630					0.39	10	0.52	13.3		
CLT50N-C630					0.51	13.0	0.65	16.6		
CLT50N-4M630										
CLT75N-C630			100	30.5	0.77	19.5	0.94	23.9		
CLT100N-C630			1250	381	0.91	23.2	1.1	28		
CLT100N-125M630										

### Nylon Solid

CLTS25N-C	Heat Stabilized Nylon 6	Black	100	30.5	0.28	7.2	0.40	10.1	-40°F – 230°F (-40°C – 110°C)	1
-----------	-------------------------	-------	-----	------	------	-----	------	------	----------------------------------	---

\*Reel packaging may contain splices. Contact Panduit Customer Service for further information  
 \*This yellow matches closely with FiberRunner® yellow

### Braided Expandable Sleeving – Polyethylene Terephthalate (PET)

- Compliant with U.S. and European passenger rail standards
- Rated for use up to 257°F (125°C)
- UL: E116868
- CSA: 227630



Part Number	Color	Nominal I.D.		Nominal Diameter Range		Length Per Reel‡		Std. Pkg. Qty.	Std. Ctn. Qty.									
		In.	mm	In.	mm	Ft.	m											
SE12P-TR0	Black	0.12	3.2	0.094 – 0.250	2.4 – 6.4	200	61.0	1	4									
SE25P-TR0																		
SE25P-MR0																		
SE25P-MR10	White	0.25	6.4	0.125 – 0.375	3.2 – 9.5	1000	304.8			2								
SE25P-MR8									Gray		0.38	9.5	0.188 – 0.500	4.8 – 12.7	200	61.0	4	
SE38P-TR0	Black	0.50	12.7	0.250 – 0.750	6.4 – 19.1	100	30.5		4									
SE38P-MR0										1000	304.8	0.75	19.1	0.500 – 1.25	12.7 – 31.8	100	30.5	4
SE50P-CR0																		
<b>BEST SELLER</b> SE50P-DR0	200	61.0	1.50	38.1	1.00 – 2.125	25.4 – 54	200		61.0	2								
SE75P-CR0											500	152.4	1.75	44.5	1.25 – 2.75	31.8 – 69.9	200	61.0
<b>BEST SELLER</b> SE75P-DR0	200	61.0	1.50	38.1	1.00 – 2.125	25.4 – 54	200	61.0	2									
SE125P-LR0										Gray	1.25	31.8	0.750 – 1.50	19.1 – 38.1	19.1 – 38.1	200	61.0	2
SE125P-TR0	Black	1.50	38.1	1.00 – 2.125	25.4 – 54	19.1 – 38.1	200	61.0	2									
SE125P-TR8										1.75	44.5	1.25 – 2.75	31.8 – 69.9	19.1 – 38.1	19.1 – 38.1	200	61.0	2
SE150P-TR0	Black	1.50	38.1	1.00 – 2.125	25.4 – 54	19.1 – 38.1	200	61.0	2									
SE175P-TR0										1.75	44.5	1.25 – 2.75	31.8 – 69.9	19.1 – 38.1	19.1 – 38.1	200	61.0	2

‡Reel packaging may contain splices. Contact Panduit Customer Service for further information

### Braided Expandable Sleeving – Flame Retardant Polyethylene Terephthalate

- Compliant with U.S. and European passenger rail standards
- Rated for use up to 257°F (125°C)
- Flammability: Meets UL 1441 VW-1
- UL E116868
- CSA: 227630



Part Number	Color	Nominal I.D.		Nominal Diameter Range		Length Per Reel‡		Std. Pkg. Qty.	Std. Ctn. Qty.									
		In.	mm	In.	mm	Ft.	m											
SE12PFR-TR0	Black	0.12	3.2	0.094 – 0.250	2.4 – 6.4	200	61.0	1	4									
SE12PFR-MR0										1000	304.8	0.25	6.4	0.125 – 0.375	3.2 – 9.5	200	61.0	4
SE25PFR-TR0																		
SE25PFR-TR8	Black	0.38	9.5	0.188 – 0.500	4.8 – 12.7	200	61.0			4								
SE25PFR-MR0									1000		304.8	0.50	12.7	0.250 – 0.750	6.4 – 19.1	100	30.5	4
SE38PFR-MR0																		
SE38PFR-TR0	200	61.0	1.25	31.8	0.750 – 1.50	19.1 – 38.1	200		61.0	2								
SE50PFR-CR0											500	152.4	1.50	38.1	1.00 – 2.125	25.4 – 54	200	61.0
<b>BEST SELLER</b> SE50PFR-DR0	200	61.0	1.50	38.1	1.00 – 2.125	25.4 – 54	200		61.0	2								
SE75PFR-CR0											500	152.4	1.75	44.5	1.25 – 2.75	31.8 – 69.9	200	61.0
SE75PFR-DR0	200	61.0	1.50	38.1	1.00 – 2.125	25.4 – 54	200	61.0	2									
SE125PFR-TR0										Black	1.50	38.1	1.00 – 2.125	25.4 – 54	19.1 – 38.1	200	61.0	2
SE150PFR-TR0	1.75	44.5	1.25 – 2.75	31.8 – 69.9	19.1 – 38.1	19.1 – 38.1	200	61.0	2									

‡Reel packaging may contain splices. Contact Panduit Customer Service for further information





### Fray Resistant Braided Expandable Sleeving

- Sleeving design resists fraying when cut with scissors
- Provides continuous abrasion protection resistance for wires, cables, and tubing
- Rated for use up to 257°F (125°C)
- Material: Polyethylene Terephthalate
- UL E116868



Part Number	Color	Nominal I.D.		Nominal Diameter Range		Length Per Reel‡		Std. Pkg. Qty.	Std. Ctn. Qty.
		In.	mm	In.	mm	Ft.	m		
<a href="#">SE38PSC-TR0</a>	Black	0.38	9.5	0.19 – 0.625	4.8 – 15.9	200	61	1	4
<a href="#">SE50PSC-CR0</a>		0.50	12.7	0.25 – 0.75	6.4 – 19.1	100	30.5		
<a href="#">SE75PSC-CR0</a>		0.75	19.1	0.63 – 1.0	15.9 – 25.4				

‡Reel packaging may contain splices. Contact Panduit Customer Service for further information



### Pan-Wrap™ Braided Sleeving

- Split wrap design allows for installation after cable routing is complete, breakouts of single and multiple cables, and addition or removal of cables post-installation
- 25% edge overlap ensures complete coverage without opening
- Highly flexible open weave will not trap heat or humidity
- Rated for use up to 257°F (125°C)
- Material: Polyethylene Terephthalate (PET)
- Flammability – Meets UL94V-0



Part Number	Color	Nominal Size Diameter		Nominal Wall Thickness		Length Per Reel		Std. Pkg. Qty.	Std. Ctn. Qty.
		In.	mm	In.	mm	Ft.	m		
<a href="#">SE50PS-CLR0</a>	Black	0.50	12.7	0.025	0.6	150	45.7	1	2
<a href="#">SE75PS-CR0</a>		0.75	19.1			100	30.5		
<a href="#">SE100PS-CR0</a>		1.00	25.4	0.038	1.0	75	22.9		
<a href="#">SE125PS-LQR0</a>		1.25	31.8		0.97	50	15.2		
<a href="#">SE200PS-LR0</a>		2	50.8						

### Tinned Copper Braided Sleeving

Part Number	Color	Nominal Diameter		Current Capacity	Length per Roll	
		In.	mm		Ft.	m
<a href="#">SE25TC-C</a>	Silver	0.25	6.4	53	100	30.5
<a href="#">SE50TC-L</a>		0.50	12.7	62	50	15.2
<a href="#">SE88TC-L</a>		0.875	22.2	100		



### Heavy Duty Nylon Braided Sleeving

Part Number	Color	Nominal Diameter		Minimum Diameter		Maximum Diameter		Length per Roll	
		In.	mm	In.	mm	In.	mm	Ft.	m
SE38N-C	Black	0.375	9.5	0.25	6.4	0.50	12.7	100	30.5
SE75N-L		0.75	19.1	0.625	15.9	1.00	25.4	50	15.2
SE150N-Q		1.50	38	1.25	31.8	1.75	44.5	25	7.62
SE175N-Q		1.75	44.5	1.50	38	2.00	50.8		
SE300N-Q		3.0	76.2	2.25	57.2	3.50	88.9		



### Insulating Fiberglass Tubing

Part Number	Color	Nominal Diameter		Wall Thickness		Length per Roll	
		In.	mm	In.	mm	Ft.	m
FT38-C	Silver	0.375	9.5	0.025	0.6	100	30.5
FT50-C		0.5	12.7				
FT62-C		0.625	15.9				
FT75-C		0.75	19.1				
FT125-C		1.25	31.8				
FT150-C		1.5	38				
FT200-L		2.0	50.8			50	15.2
FT300-L		3.0	76.2				



### Duct Seal – Sealing Compounds

- Dielectric strength: 200 V/Mil, Min 0.030 inches thick
- Temperature range: -30°F – 210°F (-34°C – 98°C)
- 10 year minimum shelf life
- Indoor use only

Part Number	Description	Std. Pkg. Qty.
<b>BEST SELLER</b> DS1	Duct seal (sealing compound) 1 lb. package	1
DS5	Duct seal (sealing compound) 5 lb. package	



### Heat Shrink End Caps

- Applications include insulating and protecting wires and cables
- Adhesive lined inner wall seals and provides excellent protection against moisture
- Voltage rating of 600 V
- Shrink ratio: 2.5:1 (HSEC)
- Temperature range: HSEC: -40°F to 257°F (-40°C to 125°C)
- For wet locations
- Material: Adhesive lined black cross-linked Polyolefin
- 10 year shelf life\*\*\*



Part Number	Min. Expanded I.D.		Max. Recovered I.D.		Nominal Recovered Wall Thickness		Usable Cap Length		Std. Pkg. Qty.	Std. Ctn. Qty.
	In.	mm	In.	mm	In.	mm	In.	mm		
HSEC0.5-X	0.47	11.9	0.18	4.6	0.09	2.2	1.48	37.6	10	100
HSEC0.8-X	0.79	20.1	0.30	7.6	0.10	2.4	1.79	45.5		

\*\*\*Shelf life applies only to expanded and recovered dimensions. Material performance is not affected

### HSTT Heat Shrink 4 Foot Pieces and Reels

- Applications include insulating, protecting, and color coding wires and cables
- Voltage: 600 V
- Shrink ratio: 2:1
- Flammability: Flame retardant EXCEPT clear
- Color: Black
- Mil Spec: AMS-DTL-23053/5 Class 1 (Colors) Class 2 (Clear)\*\*
- Temperature range: -67°F to 275°F (-55°C to 135°C)
- For dry locations
- Material: Cross-linked Polyolefin
- UL: E122770 (Except Clear)
- CSA: 222627
- 5 year shelf life\*\*\*



Part Number	Nominal Expanded I.D.		Max. Recovered I.D.		Nominal Recovered Wall Thickness		Length		Length Per Reel		Std. Pkg. Qty.	Std. Ctn. Qty.
	In.	mm	In.	mm	In.	mm	Ft.	m	Ft.	m		
HSTT06-C	0.063	1.6	0.031	0.8	0.017	0.4	—	—	100	30.5	1	10
HSTT09-48-Q	0.093	2.4	0.046	1.2	0.02	0.05	4	1.2	—	—	25	—
HSTT12-C	0.125	3.2	0.062	1.6	0.020	0.5	—	—	100	30.5	1	10
HSTT19-48-Q	0.187	4.8	0.093	2.4			4	1.2	—	—	25	—
HSTT25-48-Q	0.250	6.4	0.125	3.2	0.025	0.6	—	—	100	30.5	1	10
HSTT38-48-Q							4	1.2	—	—	25	—
HSTT38-C‡	0.375	9.5	0.187	4.8	—	—	100	30.5	1	10	—	—
HSTT50-48-5	0.500	12.7	0.250	6.4	0.030	0.8	4	1.2	—	—	5	—
HSTT50-C‡							—	—	100	30.5	1	10
HSTT75-48-5	0.750	19.1	0.375	9.5	0.035	0.9	4	1.2	—	—	5	—
HSTT75-C‡							—	—	100	30.5	1	10
HSTT100-48-5	1.00	25.4	0.500	12.7	0.040	1.0	4	1.2	—	—	5	—
HSTT100-C‡							—	—	100	30.5	1	2
HSTT150-48-5	1.50	38.1	0.750	19.1	0.045	1.1	4	1.2	—	—	5	—
HSTT150-C‡							—	—	100	30.5	1	2
HSTT200-48-5	2.00	50.8	1.00	25.4	0.050	1.3	4	1.2	—	—	5	—
HSTT200-L‡							—	—	50	15.2	1	2
HSTT300-L‡	3.00	76.2	1.50	38.1	—	—	—	—	—	—	1	0

\*For colors, add C (Clear), 1 (Brown), 2 (Red), 3 (Orange), 4 (Yellow), 45 (Yellow/Green), 5 (Green), 6 (Blue) and 10 (White) to end of part number

‡Part sold per reel

\*\*Material performance only

\*\*\*Shelf life applies only to expanded and recovered dimensions. Material performance is not affected

Product Showcase

Abrasion Protection

Cable Cleats

Cable Ties

Cable Tie Accessories

Cable Tie Tools

Identification Products

Power Connectors

Grounding Connectors

Safety Solutions

Stainless Steel Ties

Terminals

Wiring Duct

Part Number Index

### **PA** HSTTA Heat Shrink 4 Foot (1.22m) Pieces

- Applications include insulating and protecting wires and cables
- Flexible tubing with an adhesive inner wall which seals and protects components from moisture and corrosion
- Voltage rating: 600 V
- Shrink ratio: 3:1
- Flammability: Outer wall flame retardant
- Mil Spec: AMS-DTL-23053/4 Class 3\*\*
- Temperature range: -67°F to 230°F (-55°C to 110°C)
- For damp locations
- Material: Adhesive lined black cross-linked Polyolefin
- UL: E342365
- 5 year shelf life\*\*\*



Part Number	Min Expanded I.D.		Max Recovered I.D.		Nominal Recovered Wall Thickness		Std. Pkg. Qty.	Std. Ctn. Qty.
	In.	mm	In.	mm	In.	mm		
<a href="#">HSTTA25-48-TL</a>	0.250	6.4	0.080	2.0	0.040	1.0	5	—
<a href="#">HSTTA50-48-5</a>	0.500	12.7	0.160	4.1	0.070	1.8		
<a href="#">HSTTA75-48-5</a>	0.750	19.1	0.250	6.4	0.085	2.2		
<a href="#">HSTTA100-48-5</a>	1.00	25.4	0.320	8.1	0.100	2.5		
<a href="#">HSTTA150-48-5</a>	1.50	38.1	0.510	12.9				
<a href="#">HSTTA150-48-Q</a>					25			

\*\*Material performance only

\*\*\*Shelf life applies only to expanded and recovered dimensions. Material performance is not affected

### HSTTRA Heat Shrink 4 Foot (1.22m) Pieces

- Applications include insulating and protecting wires and cables
- Semi-rigid tubing with an adhesive inner wall seals and protects components from moisture and corrosion
- Voltage Rating: 600 V
- Shrink ratio: 2.5:1 minimum
- Mil Spec: AMS-DTL-23053/4 Class 1\*\*
- Temperature Range: -67°F to 230°F (-55°C to 110°C)
- For Damp Locations
- Material: Adhesive lined black cross-linked Polyolefin
- UL: E342365
- 5 year shelf life\*\*\*



Part Number	Min Expanded I.D.		Max Recovered I.D.		Nominal Recovered Wall Thickness		Std. Pkg. Qty.	Std. Ctn. Qty.
	In.	mm	In.	mm	In.	mm		
<a href="#">HSTTRA50-48-5</a>	0.5	12.7	0.195	5	0.055	1.4	5	—

\*\*Material performance only

\*\*\*Shelf life applies only to expanded and recovered dimensions. Material performance is not affected





### HST Thick Wall Polyolefin Heat Shrink

- Applications include insulating and protecting wires and cables
- Adhesive-lined inner wall seals and protects against moisture
- Thick wall suitable for direct burial according to UL 486D and provides excellent protection
- Voltage rating: UL 486D Listed for 600 V 90°C continuous use
- Shrink ratio: 3:1
- Flammability: Flame retardant outer wall meets UL 224 VW-1
- UL/UR: E342365
- UL Listed: E173379
- CSA 244528
- Mil Spec: AMS-DTL-23053/15\*\*

- Temperature range: -67°F to 230°F (-55°C to 110°C)
- Suitable for wet locations; Black HST suitable for outdoor, direct sunlight applications
- Material: Adhesive lined black and red cross-linked Polyolefin
- 10 year shelf life\*\*\*



Part Number	Min Expanded I.D.		Max Recovered I.D.		Nominal Recovered Wall Thickness		Length		Color	Std. Pkg. Qty.	Std. Ctn. Qty.		
	In.	mm	In.	mm	In.	mm	In.	mm					
<a href="#">HST0.4-48-5Y*</a>	0.40	10.2	0.16	4.1	0.08	2.0	48.0	1219.2	Black	5	20		
<a href="#">HST0.8-48-5Y*</a>	0.75	19.1	0.22	5.6	0.09	2.3						6.0	152.4
<a href="#">HST0.8-6-XY*</a>													
<a href="#">HST1.1-48-5Y</a>	1.10	27.9	0.38	9.5	0.12	3.0	48.0	1219.2		5	20		
<a href="#">HST1.5-48-5Y</a>	1.50	38.1	0.50	12.7	0.16	4.1						1219.2	15
<a href="#">HST2.0-48-2Y</a>	2.00	50.8	0.67	16.9									

The following part is not UL listed, UL recognized or CSA certified

<a href="#">HST3.0-48-2</a>	3.00	76.2	1.00	25.4	0.16	4.1	48.0	1219.2	Black	2	8
-----------------------------	------	------	------	------	------	-----	------	--------	-------	---	---

\*Product meets performance requirements of AMS-DTL-23053/15; some dimensions differ from specification

\*\*Material performance only

\*\*\*Shelf life applies only to expanded and recovered dimensions. Material performance is not affected



Like what you see and want more?

Visit [www.panduit.com](http://www.panduit.com) for the full offering of Panduit products

# Cable Entry Systems

## Increase Productivity and Stay Organized with Cable Entry Systems

Cable Entry Systems offer a safe, organized method to transition both terminated and unterminated cables through enclosures and electrical equipment, providing strain relief while maintaining IP/NEMA ingress sealing ratings. These Cable Entry Systems offer the lowest total installed cost compared to traditional cable glands or cord grips, simplifying the installation and managing numerous cables in a very dense space. These design benefits provide up to 80% installation time and space savings.



Up to 80% less space required\*

Up to 80% less install time

Manages terminated and unterminated cables

### Frames for Terminated Cables – Rectangular

- IP54 (NEMA Type 1 and 12) and IP65 (NEMA Type 1, 12, and 4X indoor use only) (with suitable grommets and cables)
- Flammability: UL94V-0
- UV Resistant
- Requires the use of CEG grommets to achieve sealing properties
  - Small Grommets accommodate 0.08" – 0.47" cable diameters
  - Medium Grommets accommodate 0.47" – 0.87" cable diameters
  - Large Grommets accommodate 0.87" – 1.18" cable diameters
- Requires four (4) user supplied 10-32 screws and nuts for mounting



CEST1 Family



CEST1 Family

Part Number	IP/NEMA Rating	Total Number of Openings	Number of Grommets and Size Required			Overall Dimensions						Std. Pkg. Qty.	Std. Ctn. Qty.
			Small	Medium	Large	Length		Width		Installed Height			
						In.	mm	In.	mm	In.	mm		
CEST1-C6	54/Type 1 and 12	6	6	—	—	3.98	101.1	2.28	57.9	0.59	15	1	50
CEST1-D7		7	—	1	—	4.76	120.9						
CEST1-D8		8	8	—	—	5.83	148.1						
CEST1-E8		6	2	—									
CEST1-E12		12	12	—	—								
CEST2-C6	65/Type 1, 12, and 4X (indoor use only)	6	6	—	—	3.98	101.1	2.28	57.9	0.71	18	1	50
CEST2-D7		7	—	1	—	4.76	120.9						
CEST2-D8		8	8	—	—	5.83	148.1						
CEST2-E8		6	2	—									
CEST2-E9		9	8	1	—								
CEST2-E12		12	12	—	—								

### Frames for Terminated Cables – Round

- IP65 (NEMA Type 1, 12, and 4X indoor use only)
- Flammability: UL94V-0
- UV Resistant
- Installs into a 2" (50.5mm) round hole
- Requires the use of CEG grommets to achieve sealing properties
- Small Grommets accommodate 0.08" – 0.47" cable diameters
- Requires four (4) user supplied 10-32 screws and nuts for mounting



Part Number	Total Number of Openings	Number of Grommets and Size Required			Overall Dimensions						Std. Pkg. Qty.	Std. Ctn. Qty.
					Length		Width		Installed Height			
		Small	Medium	Large	In.	mm	In.	mm	In.	mm		
<b>CEST2-R504</b>	4	4	0	0	2.44	62	2.44	62	0.71	18	1	50

### Grommets for Cable Entry System Frames for Terminated Cables

- Flammability: UL94V-0
- UV Resistant
- Place grommets around cables and insert into Cable Entry System Frames for Terminated Cables

Part Number	Compatibility for Frame Opening	Number of Opening for Cables	Cable Diameter		Std. Pkg. Qty.	Std. Ctn. Qty.
			In.	mm		
<b>CEG-05X1</b>	Small	1	0.20 - 0.24	5.1 - 6.1	12	1200
<b>CEG-06X1</b>			0.24 - 0.28	6.1 - 7.1		
<b>CEG-07X1</b>			0.28 - 0.31	7.1 - 7.9		
<b>CEG-08X1</b>			0.31 - 0.35	7.9 - 8.9		
<b>CEG-09X1</b>			0.35 - 0.39	8.9 - 9.9		
<b>CEG-10X1</b>			0.39 - 0.43	9.9 - 10.9		
<b>CEG-11X1</b>			0.43 - 0.47	10.9 - 11.9		
<b>CEG-12X1</b>	Medium	1	0.47 - 0.51	11.9 - 13.0	4	300
<b>CEG-13X1</b>			0.51 - 0.55	13.0 - 14.0		
<b>CEG-14X1</b>			0.55 - 0.59	14.0 - 15.0		



Part Number	Compatibility for Frame Opening	Description	Std. Pkg. Qty.	Std. Ctn. Qty.
<b>CEGBLS</b>	Small	Blank / Filler Grommet	12	1200



**Like what you see and want more?**

Visit [www.panduit.com/cable-entry-systems](http://www.panduit.com/cable-entry-systems) for the full offering of Panduit products

### Cable Entry System for Underterminated Cables – Rectangular

- IP65 (NEMA Type 1 and 12)
- Flammability: UL94HB
- UV Resistant
- Engineered cable entry system offering a high degree of strain relief
- For snap-in fastening and/or screwing in place with four (4) user supplied 10-32 screws and nuts
- Snap-in at plate thickness of 0.06" to 0.08" thick



Part Number	Total Number of Openings	Number of Openings	Size of Openings		Overall Dimensions						Std. Pkg. Qty.	Std. Ctn. Qty.
			Size of Openings		Length		Width		Installed Height			
			In	mm	In	mm	In	mm	In	mm		
<b>CESU2-E12</b>	12	12	0.31 - 0.47	7.9 - 11.9	5.79	147.1	2.32	58.9	0.59	15.0	1	50
<b>CESU2-E13</b>	13	2	0.12 - 0.22	3.0 - 5.6								
		6	0.16 - 0.32	4.1 - 8.1								
		4	0.35 - 0.55	8.9 - 14.0								
<b>CESU2-E14</b>	14	1	0.55 - 0.79	14.0 - 20.1								
		6	0.12 - 0.26	3.0 - 6.6								
<b>CESU2-E17</b>	17	4	0.20 - 0.36	5.1 - 9.1								
		4	0.38 - 0.63	9.7 - 16.0								
<b>CESU2-E17A</b>	17	11	0.12 - 0.26	3.0 - 6.6								
		1	0.16 - 0.32	4.1 - 8.1								
		5	0.31 - 0.49	7.9 - 12.4								
<b>CESU2-E22</b>	22	16	0.12 - 0.26	3.0 - 6.6								
		4	0.20 - 0.36	5.1 - 9.1								
<b>CESU2-E23</b>	23	2	0.31 - 0.49	7.9 - 12.4								
		23	0.16 - 0.32	4.1 - 8.1								
<b>CESU2-E29</b>	29	29	0.12 - 0.26	3.0 - 6.6								

### Cable Entry Membrane Plates for Underterminated Cables – Rectangular

- IP66 (NEMA Type 12 and 4X indoor use only)
- Flammability: UL94HB
- UV Resistant
- Membrane plate cable entry system offering good strain relief
- Requires four (4) user supplied 10-32 screws and nuts for mounting



Part Number	Total Number of Openings	Number of Openings	Size of Openings		Overall Dimensions						Std. Pkg. Qty.	Std. Ctn. Qty.
			Size of Openings		Length		Width		Installed Height			
			In	mm	In	mm	In	mm	In	mm		
<b>CESUM3-D12</b>	12	2	0.12 - 0.20	3.00 - 5.00	4.8	123.0	2.4	61.0	0.59	15.0	5	50
		4	0.20 - 0.35	5.00 - 9.00								
		2	0.30 - 0.47	7.50 - 12.00								
		2	0.39 - 0.63	10.00 - 16.00								
		2	0.55 - 0.79	14.00 - 20.00								
<b>CESUM3-E14</b>	14	14	0.30 - 0.47	7.50 - 12.00	5.87	149.1						
<b>CESUM3-E23</b>	23	23	0.20 - 0.35	5.00 - 9.00								

### Cable Entry Membrane Plates for Underterminated Cables – Round

- IP65 (NEMA Type 1 and 12)
- Flammability: UL94HB
- Engineered cable entry system offering a high degree of strain relief
- For snap-in fastening or securing in place with a locknut
- Snaps into panel thickness of 0.06" to 0.08"
- Locknut included is used for securement but is not UL approved



Part Number	Total Number of Openings	Number of Openings	Size of Openings		Overall Dimensions				Std. Pkg. Qty.	Std. Ctn. Qty.
			Size of Openings		Diameter		Installed Height			
			In	mm	In	mm	In	mm		
<b>CESU2-RL508</b>	8	7	0.14 - 0.26	3.6 - 6.6	2.28	58				
		1	0.24 - 0.39	6.1 - 9.9						
<b>CESU2-RL638</b>	8	2	0.12 - 0.26	3.0 - 6.6	2.8	71	0.35	8.9	1	50
		4	0.20 - 0.36	5.1 - 9.1						
		2	0.38 - 0.63	9.7 - 16.0						
<b>CESU2-RL6313</b>	13	6	0.12 - 0.22	3.0 - 5.6						
		6	0.14 - 0.26	3.6 - 6.6						
		1	0.24 - 0.39	6.1 - 9.9						



# CABLE CLEATS

---

Strapping Cable Cleats.....	22-23
Stainless Steel Cable Cleats.....	23-25
Aluminum Cable Cleats.....	24-25
Polymer Cable Cleats.....	25-26

### Strapping Cable Cleats

- Inherent cable range taking, compatible with single/multicore, trefoil, quad, and custom cable arrangements
- Strapping cleats made from 304 or 316L stainless steel
- Cushion sleeve options available as reels for custom-length applications or discrete lengths providing intuitive quick and easy installation.
- Uniclip Brackets feature high resistance to lateral and axial movement, eliminate diagonal installations, and allows Panduit stainless steel ties and straps to be installed on any style or design of cable tray; slotted or unslotted



### Locking Strap Cable Cleats

Part Number	Flat/Multicore Double Loop Cable Diameter Range		Trefoil Double Loop Cable Diameter Range		Quad Double Loop Cable Diameter Range		Width		Std. Pkg. Qty.
	In.	mm	In.	mm	In.	mm	In.	mm	
MLT4DEH15-Q316	0.47 - 3.74	12 - 95	0.47 - 1.65	12 - 42	0.47 - 1.42	12 - 36	0.50	12.70	25
MLT4DSH-Q316							0.63	15.90	
MLT6DEH15-Q316	3.74 - 5.91	95 - 150	1.65 - 2.83	42 - 72	1.42 - 2.40	36 - 61	0.50	12.70	
MLT6DSH-Q316							0.63	15.90	
MLT8DEH15-Q316	5.91 - 7.68	150 - 195	2.83 - 3.94	72 - 100	2.40 - 3.35	61 - 85	0.50	12.70	
MLT8DSH-Q316							0.63	15.90	

### Buckle Strap Cable Cleats

Part Number	Flat/Multicore Double Loop Cable Diameter Range		Flat/Multicore Triple Loop Cable Diameter Range		Trefoil Double Loop Cable Diameter Range		Trefoil Triple Loop Cable Diameter Range		Quad Double Loop Cable Diameter Range		Quad Triple Loop Cable Diameter Range		Width		Std. Pkg. Qty.
	In.	mm	In.	mm	In.	mm	In.	mm	In.	mm	In.	mm	In.	mm	
MS4W75T30-Q6	0.47-1.77	12-45	0.47-1.18	12-30	0.47-0.79	12-20	-	-	-	-	-	-	0.75	19.10	25
MS6W75T30-Q6	1.77-2.76	45-70	1.18-1.81	30-46	0.79-1.18	20-30	0.47-0.79	12-20	0.47-0.98	12-25	-	-			
MS8W75T30-Q6	2.76-3.74	70-95	1.81-2.48	46-63	1.18-1.65	30-42	0.79-1.02	20-26	0.98-1.42	25-36	0.47-0.87	12-22			
MS10W75T30-Q6	3.74-4.72	95-120	2.48-3.15	63-80	1.65-2.28	42-58	1.02-1.38	26-35	1.42-1.93	36-49	0.87-1.18	22-30			
MS12W75T30-Q6	4.72-5.91	120-150	3.15-3.94	80-100	2.28-2.83	58-72	1.38-1.73	35-44	1.93-2.4	49-61	1.18-1.46	30-37			
MS14W75T30-Q6	5.91-6.69	150-170	3.94-4.45	100-113	2.83-3.39	72-86	1.73-2.09	44-53	2.4-2.87	61-73	1.46-1.77	37-45			

### Individual Cushion Sleeves

Part Number	Flat/Multicore Cable Diameter Range		Trefoil Cable Diameter Range		Quad Cable Diameter Range		Length		Width		Thickness		Std. Pkg. Qty.
	In.	mm	In.	mm	In.	mm	In.	mm	In.	mm	In.	mm	
CSB42-150-230-Q	1.38 - 2.75	35 - 70	0.71 - 1.26	18 - 32	0.63 - 1.14	16 - 29	10.80	274	2.62	66.70	0.10	2.50	25
CSB42-230-330-Q	2.75 - 3.94	70 - 100	1.26 - 1.97	32 - 50	1.14 - 1.73	29 - 44	14.80	376					
CSB42-330-430-Q	3.94 - 5.12	100 - 130	1.97 - 2.75	50 - 70	1.73 - 2.28	44 - 58	18.80	478					

(continued on next page)

## Strapping Cable Cleats *(continued)*

### Cushion Sleeve Reels

Part Number	Material	Length		Width		Thickness		Std. Pkg. Qty.
		Ft.	m	In.	mm	In.	mm	
<b>BEST SELLER</b> PCSLSH-B-CR	TPE Low Smoke, Halogen Free	100	30.5	1.05	26.8	0.08	2.2	1
<b>BEST SELLER</b> PCSSH-B-CR	Neoprene			0.91	23.1	0.12	3.1	

### UC Series Brackets

Part Number	Description	Std. Pkg. Qty.
UCSQ1-V316	Mounting bracket – Strut Type, 316L stainless steel	5
UCIB1-V316	Mounting bracket - I-Beam, 316L stainless steel	
UCTH1-V316	Mounting Bracket - Top Hat Type, 316L Stainless Steel	

## Stainless Steel Cable Cleats

- Cable range taking capability, compatible with trefoil and quad cable arrangements
- Cable Cleats are made from 316/316L stainless steel and spacers are made from low-smoke, halogen free TPE
- Metal Cable Cleat Brackets are made from 316/316L stainless steel and allows Stainless Steel Cable Cleats to be installed on any style or design of cable tray; slotted or unslotted

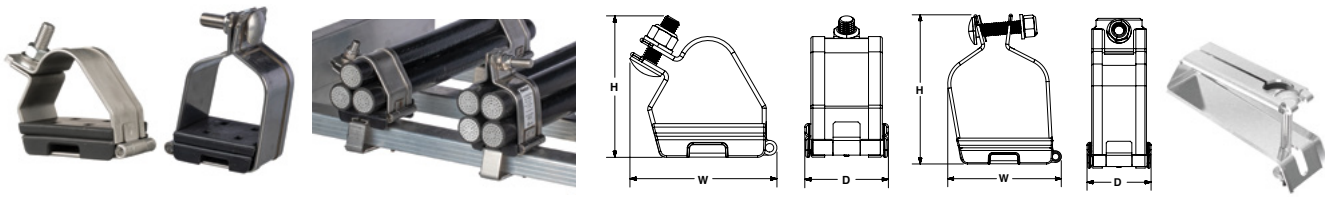

### Stainless Steel Trefoil Cable Cleats

Part Number	Cable Diameter Range		H		W		D		Weight		Mounting Holes	Std. Pkg. Qty.
	In.	mm	In.	mm	In.	mm	In.	mm	lb.	g		
CCSSTR2025-X	0.79 – 0.98	20 – 25	3.43	87	3.39	86	2.48	63	0.92	417	1 X M8	10
CCSSTR2328-X	0.91 – 1.10	23 – 28	3.58	91	3.54	90			0.97	439		
CCSSTR2632-X	1.02 – 1.26	26 – 32	3.74	95	3.82	97			1.06	480		
CCSSTR3036-X	1.18 – 1.42	30 – 36	3.94	100	4.13	105			1.14	518		
CCSSTR3440-X	1.34 – 1.58	34 – 40	4.25	108	4.37	111			1.21	547		
CCSSTR3844-X	1.50 – 1.73	38 – 44			4.69	119			1.28	581		
CCSSTR4248-X	1.65 – 1.89	42 – 48	4.41	112	4.96	126			1.35	613		
CCSSTR4652-X	1.81 – 2.05	46 – 52	4.61	117	5.24	133			1.43	647		
CCSSTR5057-X	1.97 – 2.24	50 – 57	4.84	123	5.63	143			1.51	686		
CCSSTR5461-X	2.13 – 2.40	54 – 61	5.12	130	5.91	150			1.59	720		
CCSSTR5865-X	2.28 – 2.56	58 – 65	5.43	138	6.18	157			1.66	754		
CCSSTR6269-X	2.44 – 2.72	62 – 69	5.71	145	6.50	165			1.72	782		

### Stainless Steel Quad Cable Cleats

Part Number	Cable Diameter Range		H		W		D		Weight		Mounting Holes	Std. Pkg. Qty.
	In.	mm	In.	mm	In.	mm	In.	mm	Lb.	g		
CCSSQD2226-X	0.87 – 1.02	22 – 26	4.06	103	2.76	70	2.48	63	0.89	404	1 x M8	10
CCSSQD2529-X	0.98 – 1.14	25 – 29	4.41	112	3.03	77			0.94	426		
CCSSQD2834-X	1.10 – 1.34	28 – 34	4.80	122	3.46	88			1.05	477		
CCSSQD3339-X	1.30 – 1.54	33 – 39	5.31	135	3.98	101			1.13	512		
CCSSQD3844-X	1.50 – 1.73	38 – 44	5.79	147	4.41	112			1.25	566		

(continued on next page)

### Stainless Steel Cable Cleats (continued)

#### CBH Series Brackets

Part Number	Description	Rung Height		Rung Width		Part Weight	
		In.	mm	In.	mm	lb.	g
<b>CBH15L50-V6</b>	Cleat bracket, height 15 mm, length 50 mm, 316L stainless steel	0.00 – 0.59	0 – 15	1.97	50	0.32	145
<b>CBH20L50-V6</b>	Cleat bracket, height 20 mm, length 50 mm, 316L stainless steel	0.59 – 0.79	15 – 20				
<b>CBH25L50-V6</b>	Cleat bracket, height 25 mm, length 50 mm, 316L stainless steel	0.79 – 0.98	20 – 25			0.33	151
<b>CBH30L50-V6</b>	Cleat bracket, height 30 mm, length 50 mm, 316L stainless steel	0.98 – 1.18	25 – 30				

#### Aluminum Cable Cleats

- Features rounded edges for cable protection and ridges to hold cabling in place
- Hinged trefoil cleats are designed for additional cable range-taking and nylon insert lock nut assists in vibration dampening
- One-hole and two-hole cleats are designed to be installed on the cable tray run via fixing hole(s) and user-supplied M10 bolt(s)

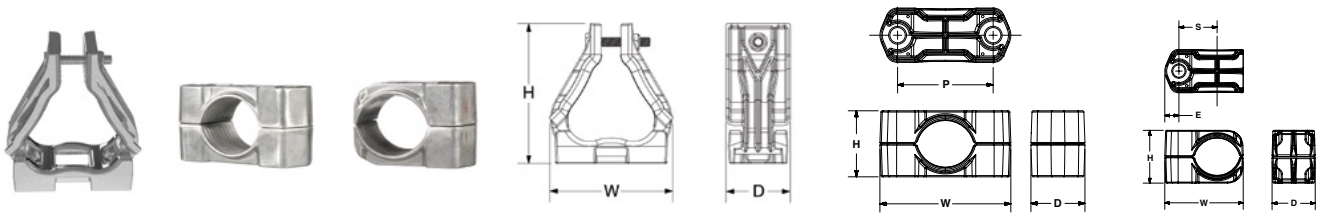

#### Aluminum Trefoil Cable Cleats

Part Number	Cable Diameter Range		H		W		D		Weight		Mounting Holes	Std. Pkg. Qty.
	In.	mm	In.	mm	In.	mm	In.	mm	lb.	g		
<b>CCALTR2326-X</b>	0.91 – 1.02	23 – 26	3.94	100	3.98	101	2.17	55	0.81	370	1 x M8	10
<b>CCALTR2528-X</b>	0.98 – 1.10	25 – 28	4.06	103	4.13	105			0.85	385		
<b>CCALTR2730-X</b>	1.06 – 1.18	27 – 30	4.21	107	3.85	98			0.87	397		
<b>CCALTR2932-X</b>	1.14 – 1.26	29 – 32	4.33	110					0.92	418		
<b>CCALTR3135-X</b>	1.22 – 1.38	31 – 35	1.57	116	3.97	101			0.93	424		
<b>CCALTR3438-X</b>	1.34 – 1.50	34 – 38	4.76	121	4.18	106			0.98	448		
<b>CCALTR3741-X</b>	1.46 – 1.61	37 – 41	4.99	127	4.41	112			1.05	477		
<b>CCALTR4044-X</b>	1.57 – 1.73	40 – 44	5.24	133	4.64	118			1.14	516		
<b>CCALTR4347-X</b>	1.69 – 1.85	43 – 47	5.52	140	4.85	123			1.23	558		
<b>CCALTR4651-X</b>	1.81 – 2.01	46 – 51	5.83	148	5.05	128			1.32	602		
<b>CCALTR5056-X</b>	1.97 – 2.20	50 – 56	6.22	158	5.50	140			1.42	647		
<b>CCALTR5561-X</b>	2.17 – 2.40	55 – 61	6.57	167	5.72	145			1.55	706		
<b>CCALTR6067-X</b>	2.36 – 2.64	60 – 67	7.01	178	6.15	156			1.73	787		
<b>CCALTR6675-X</b>	2.60 – 2.95	66 – 75	7.6	193	6.72	171						

(continued on next page)

## Aluminum Cable Cleats (continued)

### Aluminum Two-Hole Cable Cleats

Part Number	Cable Diameter Range		H		W		D		P		Weight		Mounting Holes	Std. Pkg. Qty.
	In.	mm	In.	mm	In.	mm	In.	mm	In.	mm	lb.	g		
CCAL2H3846-X	1.50 – 1.81	38 – 46	2.01	51	3.98	101	1.64	42	2.91	74	0.50	226	2 x M10	10
CCAL2H4658-X	1.81 – 2.28	46 – 58	2.36	60	4.52	115	1.69	43	3.39	86	0.64	291		
CCAL2H5870-X	2.28 – 2.76	58 – 70	2.87	73	5.20	132	1.77	45	3.97	101	0.89	404		
CCAL2H7083-X	2.76 – 3.27	70 – 83	3.39	86	5.71	145	1.81	46	4.48	114	1.09	496		
CCAL2H8397-X	3.27 – 3.82	83 – 97	3.94	100	6.37	162	1.85	47	5.07	129	1.39	630		
CCAL2H97109-X	3.82 – 4.29	97 – 109	4.53	115	3.89	175	1.93	49	5.55	141	1.66	754		
CCAL2H109120-X	4.29 – 4.72	109 – 120	5.04	128	7.33	186	1.98	50	5.99	152	1.92	873		

### Aluminum One-Hole Cable Cleats

Part Number	Cable Diameter Range		H		W		D		E		S		Weight		Mounting Holes	Std. Pkg. Qty.
	In.	mm	In.	mm	In.	mm	In.	mm	In.	mm	In.	mm	lb.	g		
CCAL1H1013-X	0.39 – 0.51	10 – 13	0.91	23	1.57	40	1.61	41	0.48	12	0.79	20	0.11	50	1 x M10	10
CCAL1H1316-X	0.51 – 0.63	13 – 16	1.02	26	1.72	44					0.83	21	0.13	59		
CCAL1H1619-X	0.63 – 0.75	16 – 19	1.14	29	1.88	48					0.91	23	0.15	68		
CCAL1H1923-X	0.75 – 0.91	19 – 23	1.26	32	2.04	52			0.51	13	0.99	25	0.17	77		
CCAL1H2327-X	0.91 – 1.06	23 – 27	1.42	36	2.28	58					1.07	27	0.20	89		
CCAL1H2732-X	1.06 – 1.26	27 – 32	1.57	40	2.44	62					1.19	30	0.24	107		
CCAL1H3238-X	1.26 – 1.50	32 – 38	1.77	45	2.68	68	1.65	42	0.55	14	1.30	33	0.27	125		
CCAL1H3846-X	1.50 – 1.81	38 – 46	2.01	51	2.98	76					1.45	37	0.33	149		
CCAL1H4651-X	1.81 – 2.01	46 – 51	2.36	60	3.26	83					1.58	40	0.40	181		
CCAL1H5157-X	2.01 – 2.24	51 – 57	2.56	65	3.49	89					1.70	43	0.44	202		

## Polymer Cable Cleats

- Features rounded edges for cable protection and ridges to hold cabling in place
- Construction features corrosion resistant body

- Cable cleats are designed to be installed on the cable tray run via fixing hole(s) and user-supplied M10 bolt(s)

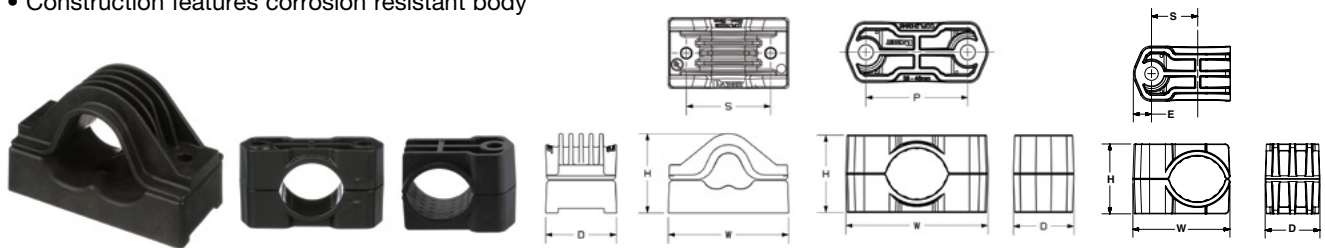

### Polymer Trefoil Cable Cleats

Part Number	Cable Diameter Range		H		W		D		S		Weight		Mounting Holes	Std. Pkg. Qty.
	In.	mm	In.	mm	In.	mm	In.	mm	In.	mm	lb.	g		
CCPLTR2228-X	0.87 – 1.10	22 – 28	3.46	88	5.20	132	3.07	78	3.62	92	1.29	585	1 X M10, 2 X M10	10
CCPLTR2633-X	1.02 – 1.30	26 – 33	3.86	98	5.59	142			4.02	102	1.39	630		
CCPLTR3139-X	1.22 – 1.54	31 – 39	4.13	105	6.06	154			4.49	114	1.51	685		
CCPLTR3745-X	1.46 – 1.77	37 – 45	4.61	117	6.54	166			4.96	126	1.64	745		
CCPLTR4352-X	1.69 – 2.05	43 – 52	5.04	128	7.09	180			5.51	140	1.80	815		
CCPLTR5060-X	1.97 – 2.36	50 – 60	5.55	141	7.76	197			6.14	156	1.97	895		

(continued on next page)



### Polymer Cable Cleats (continued)

#### Polymer Two-Hole Cable Cleats

Part Number	Cable Diameter Range		H		W		D		P		Weight		Mounting Holes	Std. Pkg. Qty.
	In.	mm	In.	mm	In.	mm	In.	mm	In.	mm	lb.	g		
<a href="#">CCPL2H3846-X</a>	1.50 – 1.81	38 – 46	2.20	56	4.07	103	1.73	44	2.92	74	0.31	143	2 x M10	10
<a href="#">CCPL2H4658-X</a>	1.81 – 2.28	46 – 58	2.56	65	4.53	115	1.74	44	3.37	86	0.38	175		
<a href="#">CCPL2H5870-X</a>	2.28 – 2.76	58 – 70	3.07	78	5.04	128	1.76	45	3.85	98	0.48	220		
<a href="#">CCPL2H7083-X</a>	2.76 – 3.27	70 – 83	3.19	81	5.56	141	1.85	47	4.36	111	0.60	273		
<a href="#">CCPL2H8397-X</a>	3.27 – 3.82	83 – 97	4.13	105	6.13	156	1.95	50	4.91	125	0.74	335		
<a href="#">CCPL2H97109-X</a>	3.82 – 4.29	97 – 109	4.72	120	6.64	169	2.06		5.40	137	0.88	402		
<a href="#">CCPL2H109120-X</a>	4.29 – 4.72	109 – 120	5.24	133	7.10	180	2.09	53	5.84	148	1.01	460		
<a href="#">CCPL2H120135-X</a>	4.72 – 5.31	120 – 135	5.71	145	7.69	195	2.17	55	6.42	163	1.17	533		
<a href="#">CCPL2H135150-X</a>	5.31 – 5.91	135 – 150	6.34	161	8.31	211	2.19	56	7.01	178	1.35	615		
<a href="#">CCPL2H150165-X</a>	5.91 – 6.50	150 – 165	6.97	177	8.92	227	2.29	58	7.61	193	1.57	712		

#### Polymer One-Hole Cable Cleats

Part Number	Cable Diameter Range		H		W		D		E		S		Weight		Mounting Holes	Std. Pkg. Qty.
	In.	mm	In.	mm	In.	mm	In.	mm	In.	mm	In.	mm	lb.	g		
<a href="#">CCPL1H1013-X</a>	0.39 – 0.51	10 – 13	1.10	28	1.74	44	1.69	43	0.56	14	0.83	21	0.08	38	1 x M10	10
<a href="#">CCPL1H1316-X</a>	0.51 – 0.63	13 – 16	1.22	31	1.87	48					0.87	22	0.10	44		
<a href="#">CCPL1H1619-X</a>	0.63 – 0.75	16 – 19	1.34	34	2.00	51					0.94	24	0.11	49		
<a href="#">CCPL1H1923-X</a>	0.75 – 0.91	19 – 23	1.46	37	2.15	55					1.01	26	0.12	56		
<a href="#">CCPL1H2327-X</a>	0.91 – 1.06	23 – 27	1.61	41	2.32	59					1.09	28	0.14	63		
<a href="#">CCPL1H2732-X</a>	1.06 – 1.26	27 – 32	1.77	45	2.52	64					1.19	30	0.16	72		
<a href="#">CCPL1H3238-X</a>	1.26 – 1.50	32 – 38	1.97	50	2.75	70	1.73	44	0.59	15	1.31	33	0.18	82		
<a href="#">CCPL1H3846-X</a>	1.50 – 1.81	38 – 46	2.28	58	3.06	78					1.46	37	0.21	96		
<a href="#">CCPL1H4651-X</a>	1.81 – 2.01	46 – 51	2.56	65	3.29	84					1.57	40	0.25	114		
<a href="#">CCPL1H5157-X</a>	2.01 – 2.24	51 – 57	2.76	70	3.53	90					1.69	43	0.28	125		



**Like what you see and want more?**

For a full offering of Panduit Cable Cleats, visit [www.panduit.com/cable-cleat-calculator](http://www.panduit.com/cable-cleat-calculator)

# CABLE TIES

---

Locking Tie Cable Ties – Nylon 6.6 .....	29-30
Locking Tie Lashing Tie – Nylon 6.6.....	30-31
Locking Tie Cable Ties – Weather Resistant Nylon 6.6 .....	32-33
Locking Tie Lashing Ties – Weather Resistant Nylon 6.6 .....	34
Locking Tie Cable Ties – Heat Stabilized Nylon 6.6 .....	35
Locking Tie Cable Ties – Heat Stabilized Weather Resistant Nylon 6.6.....	36
Locking Tie Cable Ties – Flame Retardant Nylon 6.6 .....	37
Locking Tie Cable Ties – Weather Resistant Nylon 612.....	38
Locking Tie Cable Ties – Polypropylene – Distinctive Green Color .....	39
Locking Tie Cable Ties – Weather Resistant Polypropylene.....	40
Locking Tie Cable Ties – HALAR – Distinctive Maroon Color .....	41
Locking Tie Cable Ties – TEFZEL – Distinctive Aqua Blue Color.....	42
Cable Tie Mounts – TEFZEL .....	43
Locking Tie & Cable Tie Mounts – PEEK.....	43
Locking Tie Cable Ties – Metal Detectable Nylon 6.6 and Polypropylene .....	44-45
Locking Tie Releasable Cable Ties – Nylon 6.6.....	45
Locking Tie Releasable Lashing Ties – Weather Resistant and Heat Stabilized Nylon 6.6.....	46
Locking Tie Releasable Lashing Ties – Weather Resistant Polypropylene.....	46
Locking Tie Clamp Ties – Nylon 6.6 .....	47
Locking Tie Clamp Ties – Weather Resistant and Heat Stabilized Nylon 6.6.....	48
Locking Tie Wing Push Mount Ties – Nylon 6.6.....	49
Locking Tie Wing Push Mount Ties – Heat Stabilized Nylon 6.6 .....	50
Locking Tie Releasable Wing Push Mount Ties .....	51
Locking Tie Push Mount Ties .....	52
Locking Tie Marker and Flag Ties.....	53
Dome-Top® Barb Ty Cable Ties – Nylon 6.6.....	54
Dome-Top® Barb Ty Cable Ties – Weather Resistant & Heat Stabilized Nylon 6.6.....	54-58
Dura-Ty™ Cable Ties – Weather Resistant Acetal – Heavy Cross Section .....	59
Contour-Ty® Cable Ties – Nylon 6.6.....	60
Contour-Ty® Cable Ties – Weather Resistant & Heat Stabilized Nylon 6.6.....	61-62
Hyper-V™ In-Line Cable Ties – Weather Resistant Nylon 6.6.....	62
Locking Tie Stud Mounted Cable Ties – Heat Stabilized Weather Resistant Nylon 6.6 .....	63
Locking Tie Double Loop & Clamp Cable Ties.....	64





Panduit offers a wide range of cable ties designed to meet the unique needs of multiple industries, including solar, aerospace, heavy trucking, and food and beverage. Our cable ties are made from high-quality materials and are designed to withstand even the harshest environments. No matter the industry or application, our cable ties provide a reliable and cost-effective solution for all your cable management needs.

Discover more at [www.panduit.com/wire-management](http://www.panduit.com/wire-management)



# Cable Ties

The comprehensive selection of cable tie styles, sizes, materials, and colors meets the needs of our customers. Our cable ties bundle, mount, and identify in countless indoor, outdoor, and harsh environment applications.



## Most Popular Cable Tie Styles

Cable Tie Style	Description
Locking Cable Ties	Designed to satisfy the needs of general applications, while delivering consistent performance and reliability. Featuring a curved tip to allow for easy pick up from flat surfaces and faster initial threading
Dome-Top® Barb Ties	Features a unique patented design with its round smooth edges. Paired with the stainless steel locking barb, these cable ties provide consistent performance, reliability and infinite adjustability through the entire bundle range
Releasable Cable Ties	The release tab permits easy release where changes are anticipated during development, production or servicing in the field. Ideal for heavy duty applications

## Most Popular Cable Tie Styles

Cable Tie Material	Description	Continuous Use Temperature Rating
Nylon 6.6	Nylon 6.6 material is very versatile and can be used in countless applications. Because of the plenum rating Nylon 6.6 cable ties can be used in air handling spaces. Designed to be used in indoor environments only	-76°F (-60°C) to 185°F (85°C)
Weather Resistant Nylon 6.6	Weather Resistant Nylon 6.6 material has great resistance to damage caused by ultraviolet light and can be used in both indoor and outdoor environments	
Heat Stabilized Nylon 6.6	Heat Stabilized material is designed for high temperature applications in indoor environments only	-76°F (-60°C) to 239°F (115°C)
Metal Detectable Nylon 6.6	Metal Detectable material is designed to help the food, beverage and pharmaceutical industries meet product manufacturing standards. The metal impregnated material is identifiable by metal detection equipment and is for indoor use only	-40°F (-40°C) to 185°F (85°C)
Nylon 612	Nylon 612 offers 20 years of weathering life expectancy and resistance to zinc chlorides and diluted acids. Ideal for wire management on galvanized surfaces / frames. Nylon 612 cable ties are suitable for outdoor applications	-76°F (-60°C) up to 194°F (90°C)
Tefzel	Tefzel material is ideal for applications requiring resistance to environmental stresses such as: chemical attack, gamma radiation, ultraviolet radiation, and extreme high and low temperatures, can be used in both indoor and outdoor environments	-76°F (-60°C) to 338°F (170°C)

- Product Showcase
- Abrasion Protection
- Cable Cleats
- Cable Ties**
- Cable Tie Accessories
- Cable Tie Tools
- Identification Products
- Power Connectors
- Grounding Connectors
- Safety Solutions
- Stainless Steel Ties
- Terminals
- Wiring Duct
- Part Number Index





### Locking Tie Cable Ties – Nylon 6.6

- For high temperature applications up to 185°F (85°C) – indoor use
- Versatile cable ties can be used in countless applications
- One-piece construction for consistent performance and reliability
- Among the lowest threading force of any one-piece cable tie in the industry
- Curved tip is easy to pick up from flat surfaces and allows faster initial threading to speed installation
- A variety of materials and colors available for specific applications
- UL Listed for use in plenum or air handling spaces per NEC except PLT.6SM and PLT5H/6H/8H/13H

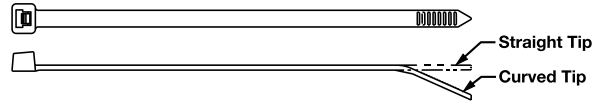

Part Number	Length In. (mm)	Width In. (mm)	Max Bundle Diameter In. (mm) <sup>a</sup>	Minimum Loop Tensile Strength Lbs. (N)	Material	Color	Resistance Properties	AH-2 Plenum Rated	UL 94 Flammability Rating	UL 62275 Type	Pkg. Qty.	Installation Tools
-------------	-----------------	----------------	---	--	----------	-------	-----------------------	-------------------	---------------------------	---------------	-----------	--------------------

#### Subminiature Cable Tie

<b>PLT.6SM-C</b>	2.8 (71)	0.070 (1.8)	0.60 (15)	8 (36)	Nylon 6.6	Natural	—	—	V-2	1, 11	100	GTS-E, PTS
------------------	----------	-------------	-----------	--------	-----------	---------	---	---	-----	-------	-----	------------

#### Miniature Cross Section

<b>PLT1M-C</b>	3.9 (99)	0.098 (2.5)	0.87 (22)	18 (80)	Nylon 6.6	Natural	—	✓	V-2	2, 21	100	GTS-E, GS2B-E, PTS, PPTS, STS2
<b>PLT1M-M</b>											1000	
<b>PLT1.5M-C</b>	5.6 (142)		1.25 (32)							100		
<b>PLT1.5M-M</b>										1000		
<b>PLT2M-C</b>	8.0 (203)		2.00 (51)							100		
<b>PLT2M-M</b>										1000		

#### Intermediate Cross Section

<b>PLT1.5I-C</b>	5.6 (142)	0.142 (3.6)	1.38 (35)	40 (178)	Nylon 6.6	Natural	—	✓	V-2	2, 21	100	GTS-E, GS2B-E, PTS, PPTS, STS2
<b>PLT1.5I-M</b>											1000	
<b>PLT2I-C</b>	8.0 (203)		2.00 (51)							100		
<b>PLT2I-M</b>										1000		
<b>PLT3I-C</b>	11.4 (290)	0.145 (3.7)	3.00 (76)							100		
<b>PLT4I-C</b>	14.5 (368)			4.00 (102)								

#### Standard Cross Section

<b>PLT2S-C</b>	7.4 (188)	0.190 (4.8)	1.88 (48)	50 (222)	Nylon 6.6	Natural	—	✓	V-2	2, 21, 2S, 21S	100	GTS-E, GS2B-E, GTH-E, GS4H-E, PTS, PPTS, PTH, STS2, STH2
<b>PLT2S-M</b>											1000	
<b>PLT3S-C</b>	11.5 (292)		3.00 (76)							100		
<b>PLT3S-M</b>										1000		
<b>PLT4S-C</b>	14.5 (368)		4.00 (102)							100		
<b>PLT4S-M</b>										1000		
<b>PLT5S-C</b>	17.5 (445)		5.00 (127)							100		





### Locking Tie Cable Ties – Nylon 6.6 (continued)

Part Number	Length In. (mm)	Width In. (mm)	Max Bundle Diameter In. (mm)	Minimum Loop Tensile Strength Lbs. (N)	Material	Color	Resistance Properties	AH-2 Plenum Rated	UL 94 Flammability Rating	UL 62275 Type	Pkg. Qty.	Installation Tools
<b>Light-Heavy Cross Section (Straight Tip)</b>												
PLT4H-L	14.5 (368)	0.300 (7.6)	4.00 (102)	120 (534)	Nylon 6.6	Natural	—	✓	V-2	2, 21	50	GTH-E, GS4H-E, GS4EH-E, PTH, STH2, ST3EH
PLT6LH-L	21.9 (556)		6.00 (152)									
PLT7LH-L	24.7 (627)		7.00 (178)									
PLT9LH-L*	30.5 (775)		9.00 (229)									

<b>Heavy Cross Section (Straight Tip)</b>												
PLT5H-L*	17.7 (450)	0.350 (8.9)	5.00 (127)	175 (778)	Nylon 6.6	Natural	—	—	V-2	1, 11	50	GTH-E, GS4H-E, GS4EH-E, PTH, STH2, ST3EH
PLT6H-L*	20.9 (530)		6.00 (152)									
PLT8H-L*	30.6 (779)		9.00 (229)									
PLT13H-Q*	43.3 (1100)		13.00 (330)								25	

\*UL Listed – meets the requirements of UL 181B-C, for securing UL Listed non-metallic air ducts and air connectors.



### Locking Tie Lashing Tie – Nylon 6.6

- For indoor use
- Typically used for heavy duty applications
- Among the strongest Panduit Locking Tie Cable Tie available
- Can be used with MCEH mounting clip

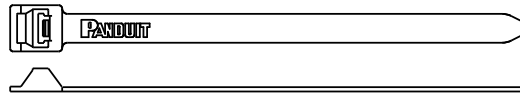

#### Extra-Heavy Cross Section

Part Number	Length In. (mm)	Width In. (mm)	Max. Bundle Dia. In. (mm)	Minimum Loop Tensile Strength Lbs. (N)	Material	Color	Resistance Properties	AH-2 Plenum Rated	UL 94 Flammability Rating	UL 62275 Type	Pkg. Qty.	Installation Tools
PLT12EH-C	40.1 (1019)	0.500 (12.7)	12.00 (305)	250 (1112)	Nylon 6.6	Natural	—	✓	V-2	2, 21	100	GS4EH-E, ST3EH



**Like what you see and want more?**

Visit [www.panduit.com](http://www.panduit.com) for the full offering of Panduit products

- Product Showcase
- Abrasion Protection
- Cable Cleats
- Cable Ties
- Cable Tie Accessories
- Cable Tie Tools
- Identification Products
- Power Connectors
- Grounding Connectors
- Safety Solutions
- Stainless Steel Ties
- Terminals
- Wiring Duct
- Part Number Index



### Locking Tie Cable Ties – Weather Resistant Nylon 6.6

- Greater resistance to damage caused by ultraviolet light – indoor or outdoor use
- Weather resistant up to 185°F (85°C)
- Versatile cable ties can be used in countless applications
- One-piece construction for consistent performance and reliability
- Among the lowest threading force of any one-piece cable tie in the industry
- Curved tip is easy to pick up from flat surfaces and allows faster initial threading to speed installation
- UL Listed for use in plenum or air handling spaces per NEC except PLT.6SM and PLT5H/6H/8H/13H

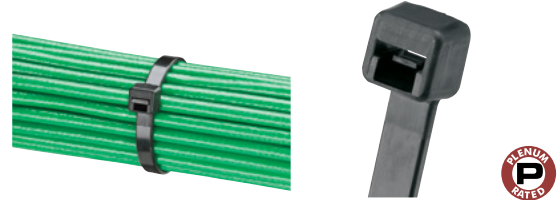
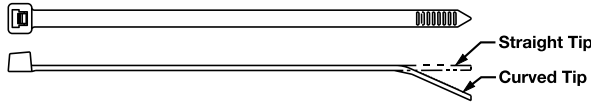

Part Number	Length In. (mm)	Width In. (mm)	Max Bundle Diameter In. (mm)	Minimum Loop Tensile Strength Lbs. (N)	Material	Color	Resistance Properties	AH-2 Plenum Rated	UL 94 Flammability Rating	UL 62275 Type	Pkg. Qty.	Installation Tools
<b>Miniature Cross Section</b>												
PLT.7M-M0	3.1 (79)	0.090 (2.3)	0.68 (17)	18 (80)	Weather Resistant Nylon 6.6	Black	UV Resistant	✓	V-2	2, 21	1000	GTS-E, GS2B-E, PTS, PPTS, STS2
PLT1M-C0	3.9 (99)	0.098 (2.5)	0.87 (22)								100	
<b>BEST SELLER</b> PLT1M-M0			1000									
PLT1.5M-C0	5.6 (142)	0.098 (2.5)	1.25 (32)								100	
PLT2M-C0	8.0 (203)		2.00 (51)								1000	
<b>BEST SELLER</b> PLT2M-M0			1000									

<b>Intermediate Cross Section</b>												
PLT1.5I-C0	5.6 (142)	0.142 (3.6)	1.38 (35)	40 (178)	Weather Resistant Nylon 6.6	Black	UV Resistant	✓	V-2	2, 21	100	GTS-E, GS2B-E, PTS, PPTS, STS2
<b>BEST SELLER</b> PLT1.5I-M0			1000									
PLT2I-C0	8.0 (203)	0.145 (3.7)	2.00 (51)								100	
<b>BEST SELLER</b> PLT2I-M0			1000									
PLT3I-C0	11.4 (290)	0.145 (3.7)	3.00 (76)								100	
<b>BEST SELLER</b> PLT3I-M0			1000									
PLT4I-C0	14.5 (368)		4.00 (102)	100								

(continued on next page)



**Like what you see and want more?**

Visit [www.panduit.com](http://www.panduit.com) for the full offering of Panduit products



## Locking Tie Cable Ties – Weather Resistant Nylon 6.6 (continued)

Part Number	Length In. (mm)	Width In. (mm)	Max Bundle Diameter In. (mm)	Minimum Loop Tensile Strength Lbs. (N)	Material	Color	Resistance Properties	AH-2 Plenum Rated	UL 94 Flammability Rating	UL 62275 Type	Pkg. Qty.	Installation Tools								
<b>Standard Cross Section</b>																				
<b>BEST SELLER</b> PLT2S-C0	7.4 (188)	0.190 (4.8)	1.88 (48)	50 (222)	Weather Resistant Nylon 6.6	Black	UV Resistant	✓	V-2	2, 21, 2S, 21S	100	GTS-E, GS2B-E, GTH-E, GS4H-E, PTS, PPTS, PTH, STS2, STH2								
PLT2.5S-C0	9.8 (249)	0.190 (4.8)	2.50 (64)																	
<b>BEST SELLER</b> PLT2S-M0	7.4 (188)	0.190 (4.8)	1.88 (48)								1000									
<b>BEST SELLER</b> PLT3S-C0	11.5 (292)	0.190 (4.8)	3.00 (76)								100									
<b>BEST SELLER</b> PLT3S-M0	11.5 (292)	0.190 (4.8)	3.00 (76)								1000									
<b>BEST SELLER</b> PLT4S-C0	14.5 (368)	0.190 (4.8)	4.00 (102)								100									
<b>BEST SELLER</b> PLT4S-M0	14.5 (368)	0.190 (4.8)	4.00 (102)								1000									
<b>BEST SELLER</b> PLT5S-C0	17.5 (445)	0.190 (4.8)	5.00 (127)								100									
<b>Light-Heavy Cross Section</b>																				
PLT6LH-L0	21.9 (556)	0.300 (7.6)	6.00 (152)								120 (534)		Weather Resistant Nylon 6.6	Black	UV Resistant	✓	V-2	2, 21	50	GTH-E, GS4H-E, GS4EH-E, PTH, STH2, ST3EH
PLT7LH-L0	24.7 (627)	0.300 (7.6)	7.00 (176)																	
PLT9LH-L0	30.5 (775)	0.300 (7.6)	9.00 (229)																	
<b>Heavy Cross Section (Straight Tip)</b>																				
PLT5H-L0	17.7 (450)	0.350 (8.9)	5.00 (127)	175 (778)	Weather Resistant Nylon 6.6	Black	UV Resistant	–	V-2	1, 11	50	GTH-E, GS4H-E, GS4EH-E, PTH, STH2, ST3EH								
PLT6H-L0	20.9 (530)	0.350 (8.9)	6.00 (152)																	
PLT8H-L0	30.6 (779)	0.350 (8.9)	9.00 (229)								✓									
PLT13H-Q0	43.3 (1100)	0.350 (8.9)	13.00 (330)					–			25									
PLT2H-L0	8.1 (206)	0.300 (7.6)	2.00 (51)					✓			50									
PLT3H-L0	11.4 (290)	0.300 (7.6)	3.00 (76)																	
<b>BEST SELLER</b> PLT4H-L0	14.5 (368)	0.300 (7.6)	4.00 (102)																	
<b>BEST SELLER</b> PLT4H-TL0	14.5 (368)	0.300 (7.6)	4.00 (102)																	
PLT4H-TL0/147	14.5 (368)	0.300 (7.6)	4.11 (104.5)					–			250									







**Locking Tie Lashing Ties – Weather Resistant Nylon 6.6**

- For high temperature applications up to 185°F (85°C) – indoor/outdoor use
- Typically used for heavy duty applications
- Among the strongest Panduit Locking Cable Ties available
- Can be used with MCEH mounting clip

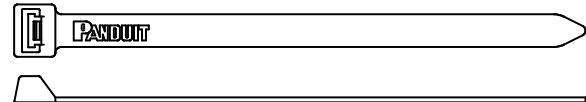
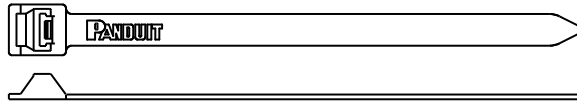

Lashing Tie

No Buckle Design



Part Number	Length In. (mm)	Width In. (mm)	Max Bundle Diameter In. (mm)	Minimum Loop Tensile Strength Lbs. (N)	Material	Color	Resistance Properties	AH-2 Plenum Rated	UL 94 Flammability Rating	UL 62275 Type	Pkg. Qty.	Installation Tools
<b>Extra-Heavy Cross Section</b>												
<b>PLT5EH-Q0</b>	20.1 (511)	0.500 (12.7)	5.00 (127)	250 (1112)	Weather Resistant Nylon 6.6	Black	UV Resistant	–	V-2	1, 11	25	GS4EH-E, ST3EH
<b>PLT6EH-Q0</b>	22.2 (564)	0.500 (12.7)	6.00 (152)									
<b>Extra-Heavy Cross Section (No Buckle Design)</b>												
<b>PLT5EH-NB-C0</b>	19.8 (503)	0.500 (12.7)	5.00 (127)	250 (1112)	Weather Resistant Nylon 6.6	Black	UV Resistant	–	V-2	1, 11	100	GS4EH-E, ST3EH



**Like what you see and want more?**

Visit [www.panduit.com](http://www.panduit.com) for the full offering of Panduit products



## Locking Tie Cable Ties – Heat Stabilized Nylon 6.6

- For high temperature applications up to 239°F (115°C) – indoor use
- One-piece construction for consistent performance and reliability
- Among the lowest threading force of any one-piece cable tie in the industry
- Curved tip is easy to pick up from flat surfaces and allows faster initial threading to speed installation

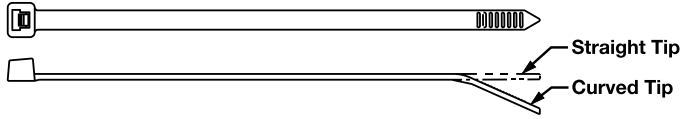

Part Number	Length In. (mm)	Width In. (mm)	Max Bundle Diameter In. (mm)	Minimum Loop Tensile Strength Lbs. (N)	Material	Color	Resistance Properties	AH-2 Plenum Rated	UL 94 Flammability Rating	UL 62275 Type	Pkg. Qty.	Installation Tools
-------------	-----------------	----------------	------------------------------	--	----------	-------	-----------------------	-------------------	---------------------------	---------------	-----------	--------------------

### Subminiature Cross Section

<b>PLT.6SM-M30</b>	2.8 (71)	0.070 (1.8)	.60 (15)	8 (36)	Heat Stabilized Nylon 6.6	Black	Heat Resistant	—	V-2	1, 11	1000	GTS-E, PTS
--------------------	----------	-------------	----------	--------	---------------------------	-------	----------------	---	-----	-------	------	------------

### Miniature Cross Section

Part Number	Length In. (mm)	Width In. (mm)	Max Bundle Diameter In. (mm)	Minimum Loop Tensile Strength Lbs. (N)	Material	Color	Resistance Properties	AH-2 Plenum Rated	UL 94 Flammability Rating	UL 62275 Type	Pkg. Qty.	Installation Tools
<b>PLT1M-M30</b>	3.9 (99)		0.87 (22)	18 (80)	Heat Stabilized Nylon 6.6	Black	Heat Resistant	—	V-2	2, 21	1000	GTS-E, GS2B-E, PTS, PPTS, STS2
<b>PLT1.5M-M30</b>	5.6 (142)	0.098 (2.5)	1.25 (32)									
<b>PLT2M-M30</b>	8.0 (203)		2.00 (51)									

### Intermediate Cross Section

<b>PLT2I-C30</b>	8.0 (203)	0.142 (3.6)	2.00 (51)	40 (178)	Heat Stabilized Nylon 6.6	Black	Heat Resistant	—	V-2	2, 21	100	GTS-E, GS2B-E, PTS, PPTS, STS2
<b>PLT3I-M30</b>	11.4 (290)	0.145 (3.7)	3.00 (76)								1000	
<b>PLT4I-M30</b>	14.5 (368)		4.00 (102)									

### Standard Cross Section

<b>PLT1S-M30</b>	4.8 (122)	0.190 (4.8)	1.00 (25)	50 (222)	Heat Stabilized Nylon 6.6	Black	Heat Resistant	—	V-2	2, 21	1000	GTS-E, GS2B-E, GTH-E, GS4H-E, PTS, PPTS, PTH, STS2, STH2
<b>PLT5S-M30</b>	17.5 (445)		5.00 (127)									

### Light-Heavy Cross Section (Straight Tip)

<b>PLT2H-TL30</b>	8.1 (206)	0.300 (7.6)	2.00 (51)	120 (534)	Heat Stabilized Nylon 6.6	Black	Heat Resistant	—	V-2	2, 21	250	GTH-E, GS4H-E, GS4EH-E, PTH, STH2, ST3EH
<b>PLT3H-TL30</b>	11.4 (290)		3.00 (76)									
<b>PLT4H-TL30</b>	14.5 (368)		4.00 (102)									
<b>PLT7LH-C30</b>	24.7 (627)		7.00 (178)									
<b>PLT9LH-C30</b>	30.5 (775)		9.00 (229)									

### Heavy Cross Section (Straight Tip)

<b>PLT5H-C30</b>	17.7 (450)	0.350 (8.9)	5.00 (127)	175 (778)	Heat Stabilized Nylon 6.6	Black	Heat Resistant	—	V-2	1, 11	100	GTH-E, GS4H-E, GS4EH-E, PTH, STH2, ST3EH
<b>PLT6H-C30</b>	20.9 (530)		6.00 (152)									
<b>PLT8H-C30</b>	30.6 (779)		9.00 (229)									





### Locking Tie Cable Ties – Heat Stabilized Weather Resistant Nylon 6.6

- Greater resistance to damage caused by ultraviolet light and for high temperature applications up to 239°F (115°C) – indoor or outdoor use
- One-piece construction for consistent performance and reliability
- Among the lowest threading force of any one-piece cable tie in the industry
- Curved tip is easy to pick up from flat surfaces and allows faster initial threading to speed installation

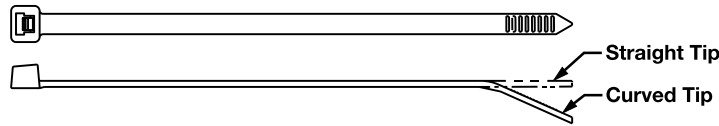

Part Number	Length In. (mm)	Width In. (mm)	Max Bundle Diameter In. (mm)	Minimum Loop Tensile Strength Lbs. (N)	Material	Color	Resistance Properties	AH-2 Plenum Rated	UL 94 Flammability Rating	UL 62275 Type	Pkg. Qty.	Installation Tools
-------------	-----------------	----------------	------------------------------	--	----------	-------	-----------------------	-------------------	---------------------------	---------------	-----------	--------------------

#### Miniature Cross Section

PLT1M-M300	3.9 (99)	0.098 (2.5)	0.87 (22)	18 (80)	Heat Stabilized Weather Resistant Nylon 6.6	Black	Heat and UV Resistant	✓	V-2	2	1000	GTS-E, GS2B-E, PTS, PPTS, STS2
------------	----------	-------------	-----------	---------	---	-------	-----------------------	---	-----	---	------	--------------------------------

#### Intermediate Cross Section

PLT2I-M300	8.0 (203)	0.142 (3.6)	2.00 (51)	40 (178)	Heat Stabilized Weather Resistant Nylon 6.6	Black	Heat and UV Resistant	✓	V-2	2	1000	GTS-E, GS2B-E, PTS, PPTS, STS2
------------	-----------	-------------	-----------	----------	---	-------	-----------------------	---	-----	---	------	--------------------------------

#### Standard Cross Section

PLT2S-M300	7.4 (188)	0.190 (4.8)	1.88 (48)	50 (222)	Heat Stabilized Weather Resistant Nylon 6.6	Black	Heat and UV Resistant	✓	V-2	2	1000	GTS-E, GS2B-E, GTH-E, GS4H-E, PTS, PTH, PPTS, STS2, STH2
PLT4S-M300	14.5 (368)	0.190 (4.8)	4.00 (102)									

#### Light-Heavy Cross Section (Straight Tip)

PLT4H-TL300	14.5 (368)	0.300 (7.6)	4.00 (102)	120 (534)	Heat Stabilized Weather Resistant Nylon 6.6	Black	Heat and UV Resistant	✓	V-2	2	1000	GTH-E, GS4H-E, GS4EH-E, PTH, STH2, ST3EH
-------------	------------	-------------	------------	-----------	---	-------	-----------------------	---	-----	---	------	--



### Locking Tie Cable Ties – Flame Retardant Nylon 6.6

- For high temperature applications up to 212°F (100°C) – indoor use
- Flammability rating of UL 94V-0
- One-piece construction for consistent performance and reliability
- Among the lowest threading force of any one-piece cable tie in the industry
- Curved tip is easy to pick up from flat surfaces and allows faster initial threading to speed installation

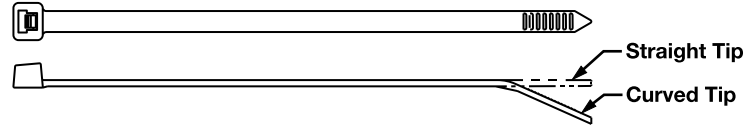

Part Number	Length In. (mm)	Width In. (mm)	Max Bundle Diameter In. (mm)	Minimum Loop Tensile Strength Lbs. (N)	Material	Color	Resistance Properties	AH-2 Plenum Rated	UL 94 Flammability Rating	UL 62275 Type	Pkg. Qty.	Installation Tools
<b>Miniature Cross Section</b>												
PLT1M-M69	4.0 (102)	0.098 (2.5)	0.87 (22)	18 (80)	Flame Retardant Nylon 6.6	Ivory	Flame Retardant	—	V-0	1, 11	1000	GTS-E, GS2B-E, PTS, PPTS, STS2
<b>Standard Cross Section</b>												
PLT4S-M69	14.5 (368)	0.190 (4.8)	4.00 (102)	50 (222)	Flame Retardant Nylon 6.6	Ivory	Flame Retardant	—	V-0	1, 11	1000	GTS-E, GS2B-E, GTH-E, GS4H-E, PTS, PTH, PPTS, STS2, STH2
<b>Light-Heavy Cross Section (Straight Tip)</b>												
PLT4H-TL69	14.6 (371)	0.300 (7.6)	4.00 (102)	120 (534)	Flame Retardant Nylon 6.6	Ivory	Flame Retardant	—	V-0	1, 11	250	GTH-E, GS4H-E, GS4EH-E, PTH, STH2, ST3EH



**Like what you see and want more?**

Visit [www.panduit.com](http://www.panduit.com) for the full offering of Panduit products

- Product Showcase
- Abrasion Protection
- Cable Cleats
- Cable Ties
- Cable Tie Accessories
- Cable Tie Tools
- Identification Products
- Power Connectors
- Grounding Connectors
- Safety Solutions
- Stainless Steel Ties
- Terminals
- Wiring Duct
- Part Number Index

### Locking Tie Cable Ties – Weather Resistant Nylon 612

- Excellent UV resistance providing up to a 20-year life expectancy
- For high moisture, corrosive (zinc chloride and dilute acids), and low temperature indoor or outdoor applications
- Cable tie of choice for making attachments to galvanized surfaces
- One-piece construction for consistent performance and reliability
- Among the lowest threading force of any one-piece cable tie in the industry
- Curved tip is easy to pick up from flat surfaces and allows faster initial threading to speed installation

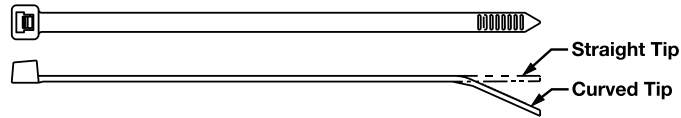

Part Number	Length In. (mm)	Width In. (mm)	Thickness In. (mm)	Max Bundle Diameter In. (mm)	Minimum Loop Tensile Strength Lbs. (N)	Recommended Installation Tool	Pkg. Qty.*	Bulk Ctn. Qty.
<b>Miniature Cross Section</b>								
PLT1M-M6120	3.9 (99)	0.098 (2.5)	0.043 (1.1)	0.87 (22)	20 (89)	GTS-E, GS2B-E, PTS, PPTS, STS2	1,000	50,000
PLT1M-C6120							100	1,000
<b>Intermediate Cross Section</b>								
PLT1.5I-M6120	5.6 (142)	0.142 (3.6)	0.045 (1.1)	1.38 (35)	25 (111)	GTS-E, GS2B-E, PTS, PPTS, STS2	1,000	25,000
PLT1.5I-C6120							100	1,000
<b>Standard Cross Section</b>								
PLT2S-M6120	7.4 (188)	0.19 (4.8)	0.047 (1.2)	1.88 (48)	50 (222)	GTS-E, GS2B-E, GTH-E, GS4H-E, PTS, PTH, PPTS, STS2, STH2	1,000	10,000
PLT2S-C6120				100			1,000	
PLT2.5S-M6120	9.8 (249)		2.5 (64)	1,000			10,000	
PLT2.5S-C6120			100	1,000				
PLT3S-M6120	11.5 (292)		0.052 (1.3)	3.0 (76)			1,000	10,000
PLT3S-C6120			100	1,000				
PLT4S-M6120	14.5 (368)		4.0 (102)	1,000			5,000	
PLT4S-C6120			100	1,000				
<b>Light-Heavy Cross Section</b>								
PLT4H-TL6120	14.5 (368)	0.3 (7.6)	0.075 (1.9)	4.0 (102)	120 (534)	GTH-E, GS4H-E, GS4EH-E, PTH, STH2, ST3EH	250	1,000
PLT7LH-C6120	24.7 (627)			7.0 (178)			100	2,000
PLT8LH-C6120	27.6 (701)			8.0 (203)				

\*Order number of pieces required, in multiples of Packages Quantity



**Like what you see and want more?**

Visit [www.panduit.com](http://www.panduit.com) for the full offering of Panduit products

### Locking Tie Cable Ties – Polypropylene – Distinctive Green Color

- For chemical resistance where high loop tensile strength is not required especially in the presence of hydrochloric acid, salts, and bases
- For high temperature applications up to 239°F (115°C) – indoor use
- One-piece construction for consistent performance and reliability
- Among the lowest threading force of any one-piece cable tie in the industry
- Curved tip is easy to pick up from flat surfaces and allows faster initial threading to speed installation

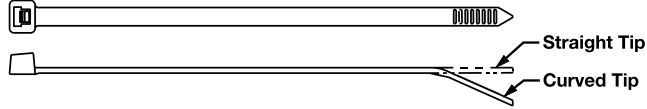

#### Standard Cross Section

Part Number	Length In. (mm)	Width In. (mm)	Max Bundle Diameter In. (mm)	Minimum Loop Tensile Strength Lbs. (N)	Material	Color	Resistance Properties	AH-2 Plenum Rated	UL 94 Flammability Rating	UL 62275 Type	Pkg. Qty.	Installation Tools
PLT2S-M109	7.4 (188)	0.190 (4.8)	1.88 (48)	30 (133)	Polypropylene	Green	Chemical Resistant	—	HB	—	1000	GTS-E, GS2B-E, GTH-E, GS4H-E, PTS, PTH, PPTS, STS2, STH2
PLT3S-M109	11.5 (292)		3.00 (76)									
PLT4S-M109	14.5 (368)		4.00 (102)									



**Like what you see and want more?**

Visit [www.panduit.com](http://www.panduit.com) for the full offering of Panduit products

### Locking Tie Cable Ties – Weather Resistant Polypropylene

- For high temperature applications up to 239°F (115°C) – indoor/outdoor use
- For chemical resistance where high loop tensile strength is not required especially in the presence of hydrochloric acid, salts, and bases
- Greater resistance to damage caused by ultraviolet light – indoor or outdoor use
- One-piece construction for consistent performance and reliability
- Among the lowest threading force of any one-piece cable tie in the industry
- Curved tip is easy to pick up from flat surfaces and allows faster initial threading to speed installation

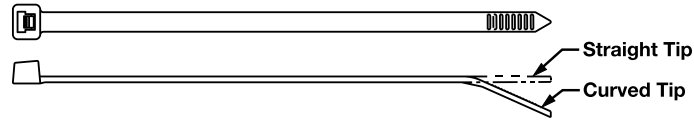

Part Number	Length In. (mm)	Width In. (mm)	Max Bundle Diameter In. (mm)	Minimum Loop Tensile Strength Lbs. (N)	Material	Color	Resistance Properties	AH-2 Plenum Rated	UL 94 Flammability Rating	UL 62275 Type	Pkg. Qty.	Installation Tools
-------------	-----------------	----------------	------------------------------	--	----------	-------	-----------------------	-------------------	---------------------------	---------------	-----------	--------------------

#### Miniature Cross Section

<b>PLT1M-M100</b>	3.9 (99)	0.098 (2.5)	0.87 (22)	11 (49)	Weather Resistant Polypropylene	Black	Chemical and UV Resistant	—	HB	—	1000	GTS-E, GS2B-E, PTS, PPTS, STS2
-------------------	----------	-------------	-----------	---------	---------------------------------	-------	---------------------------	---	----	---	------	--------------------------------

#### Intermediate Cross Section

<b>PLT1.5I-M100</b>	5.6 (142)	0.142 (3.6)	1.38 (35)	18 (80)	Weather Resistant Polypropylene	Black	Chemical and UV Resistant	—	HB	—	1000	GTS-E, GS2B-E, PTS, PPTS, STS2
---------------------	-----------	-------------	-----------	---------	---------------------------------	-------	---------------------------	---	----	---	------	--------------------------------

#### Standard Cross Section

<b>PLT2S-M100</b>	7.4 (188)	0.190 (4.8)	1.88 (48)	30 (133)	Weather Resistant Polypropylene	Black	Chemical and UV Resistant	—	HB	—	1000	GTS-E, GS2B-E, GTH-E, GS4H-E, PTS, PTH, PPTS, STS2, STH2
<b>PLT3S-M100</b>	11.5 (292)		3.00 (76)									
<b>PLT4S-M100</b>	14.5 (368)		4.00 (102)									

#### Light-Heavy Cross Section (Straight Tip)

<b>PLT2H-TL100</b>	8.1 (206)	0.300 (7.6)	2.00 (51)	50 (222)	Weather Resistant Polypropylene	Black	Chemical and UV Resistant	—	HB	—	250	GTH-E, GS4H-E, GS4EH-E, PTH, STH2, ST3EH
<b>PLT3H-TL100</b>	11.4 (290)		3.00 (76)									
<b>PLT4H-TL100</b>	14.5 (368)		4.00 (102)									





### Locking Tie Cable Ties – HALAR\* – Distinctive Maroon Color

- For high temperature applications up to 257°F (125°C)
- UL Listed for use in plenum or air handling spaces per NEC, Section 300-22 (C) and (D)
- Low smoke density and excellent flammability rating of UL 94V-0
- Commonly accepted solution for bundling qualified cable without conduit in air handling space applications
- Greater resistance to damage caused by ultraviolet light – indoor or outdoor use
- One-piece construction for consistent performance and reliability
- Among the lowest threading force of any one-piece cable tie in the industry
- Curved tip is easy to pick up from flat surfaces and allows faster initial threading to speed installation
- Provides primary support for a flexible conduit, flexible tubing, or cable in accordance with the relevant national installation code

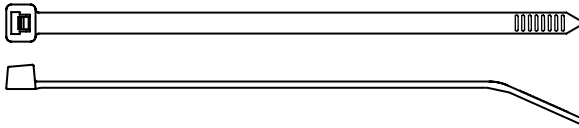

Part Number	Length In. (mm)	Width In. (mm)	Max Bundle Diameter In. (mm)	Minimum Loop Tensile Strength Lbs. (N)	Material	Color	Resistance Properties	AH-2 Plenum Rated	UL 94 Flammability Rating	UL 62275 Type	Pkg. Qty.	Installation Tools
-------------	-----------------	----------------	------------------------------	--	----------	-------	-----------------------	-------------------	---------------------------	---------------	-----------	--------------------

#### Miniature Cross Section

<b>PLT1M-C702Y</b>	4.0 (102)	0.098 (2.5)	0.87 (22)	18 (80)	HALAR	Maroon	Heat and UV Resistant	✓	V-0	2, 21	100	GTS-E, GS2B-E, PTS, PPTS, STS2
--------------------	-----------	-------------	-----------	---------	-------	--------	-----------------------	---	-----	-------	-----	--------------------------------

#### Standard Cross Section

<b>PLT2S-C702Y</b>	7.4 (188)	0.190 (4.8)	1.88 (48)	50 (222)	HALAR	Maroon	Heat and UV Resistant	✓	V-0	2, 21, 2S, 21S	100	GTS-E, GS2B-E, GTH-E, GS4H-E, PTS, PTH, PPTS, STS2, STH2
<b>PLT3S-C702Y</b>	11.6 (295)	0.190 (4.8)	3.00 (76)									

\*HALAR is a registered trademark of Solvay Solexis



**Like what you see and want more?**

Visit [www.panduit.com](http://www.panduit.com) for the full offering of Panduit products

### UL US C<sup>UL</sup> SP<sup>UL</sup> Locking Tie Cable Ties – TEFZEL\*\* – Distinctive Aqua Blue Color

- For high temperature applications up to 338°F (170°C) – indoor/outdoor use
- Ideal for applications requiring resistance to environmental stresses such as chemical attack, gamma radiation, ultraviolet radiation and extreme high and low temperatures
- Ideal for use in nuclear power facilities and chemical processing plants and meets the requirements of IEEE 383
- Low smoke density and excellent flammability rating of UL 94V-0
- One-piece construction for consistent performance and reliability
- Among the lowest threading force of any one-piece cable tie in the industry
- Curved tip is easy to pick up from flat surfaces and allows faster initial threading to speed installation

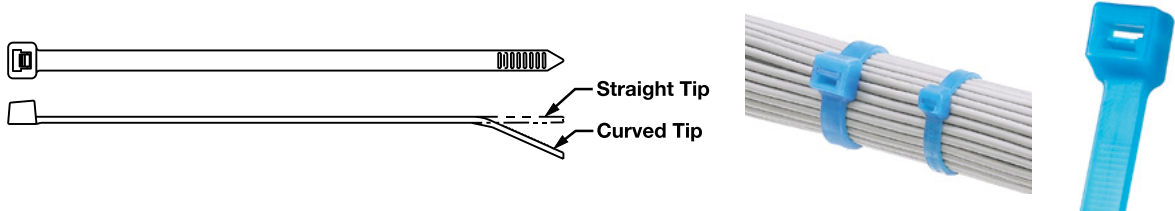

Part Number	Length In. (mm)	Width In. (mm)	Max Bundle Diameter In. (mm)	Minimum Loop Tensile Strength Lbs. (N)	Material	Color	Resistance Properties	AH-2 Plenum Rated	UL 94 Flammability Rating	UL 62275 Type	Pkg. Qty.	Installation Tools
-------------	-----------------	----------------	------------------------------	--	----------	-------	-----------------------	-------------------	---------------------------	---------------	-----------	--------------------

#### Miniature Cross Section

<b>PLT1M-C76</b>	4.0 (102)	0.098 (2.5)	0.87 (22)	18 (80)	TEFZEL	Aqua	Chemical, Radiation, UV and High Heat Resistant	—	V-0	1, 11	100	GTS-E, GS2B-E, PTS, PPTS, STS2
<b>PLT1M-M76</b>											1000	

#### Intermediate Cross Section

<b>PLT2I-C76</b>	8.0 (203)	0.135 (3.4)	2.00 (51)	30 (133)	TEFZEL	Aqua	Chemical, Radiation, UV and High Heat Resistant	—	V-0	1, 11	100	GTS-E, GS2B-E, PTS, PPTS, STS2
<b>PLT2I-M76</b>											1000	

#### Standard Cross Section

<b>PLT2S-C76</b>	7.4 (188)	0.190 (4.8)	1.88 (48)	50 (222)	TEFZEL	Aqua	Chemical, Radiation, UV and High Heat Resistant	—	V-0	1, 11	100	GTS-E, GS2B-E, GTH-E, GS4H-E, PTS, PTH, PPTS, STS2, STH2
<b>PLT3S-C76</b>	11.6 (295)		3.00 (76)									
<b>PLT4S-C76</b>	14.6 (371)		4.00 (102)									

#### Light-Heavy Cross Section (Straight Tip)

<b>PLT3H-L76</b>	11.5 (292)	0.300 (7.6)	3.00 (78)	120 (534)	TEFZEL	Aqua	Chemical, Radiation, UV and High Heat Resistant	—	V-0	1, 11	50	GTH-E, GS4H-E, GS4EH-E, PTH, STH2, ST3EH
<b>PLT4H-L76</b>	14.6 (371)		4.00 (102)									
<b>PLT4H-TL76</b>			250									

\*\*TEFZEL is a registered trademark of The Chemours Company



## Cable Tie Mounts – TEFZEL\*\*

- Flammability rating of UL 94V-0 – indoor use
- Unique cradle design provides maximum stability for the cable bundle
- Low profile design keeps bundle close to mounting surface

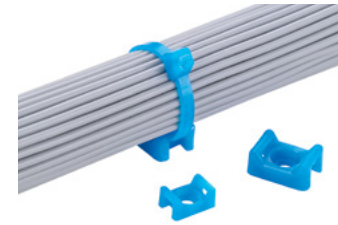
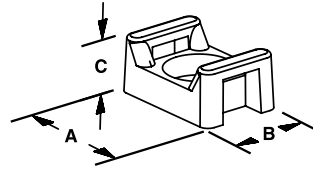

Part Number	Used with Cable Ties*	Length A		Width B		Height C		Counterbore Diameter		Mounting Method	Std. Pkg. Qty.	Std. Ctn. Qty.
		In.	mm	In.	mm	In.	mm	In.	mm			
TM2S8-C76	M, I, S	0.63	16.0	0.43	10.8	0.28	7.0	0.30	7.6	#8 (M4) screw	100	500
TM3S8-C76	S, LH	0.86	21.7	0.62	15.5	0.38	9.5	0.37	9.4			
TM3S10-C76				0.62	15.8					#10 (M5) screw		

\*Cable tie cross section sizes: M = Miniature, I = Intermediate, S = Standard, LH = Light-Heavy.  
 \*\*Tefzel is a registered trademark of The Chemours Company.

## Locking Tie Cable Ties – PEEK (Polyetheretherketone)

- Ideal for harsh environments where a cable tie material is required to hold up to chemical or radiation exposure
- Non-conductive material that is excellent for high temperature applications up to 500°F (260°C)
- High strength properties over a wide range of temperatures
- Flammability rating of UL 94V-0 with low smoke and toxicity; halogen-free
- PEEK material meets MIL specification MIL-P-46183, and is approved for use by the Department of Defense
- One-piece construction for consistent performance and reliability
- Among the lowest threading force of any one-piece cable tie in the industry

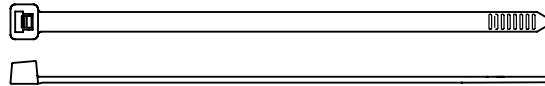

Part Number	Length In. (mm)	Width In. (mm)	Max Bundle Diameter In. (mm)	Minimum Loop Tensile Strength Lbs. (N)	Material	Color	Resistance Properties	AH-2 Plenum Rated	UL 94 Flammability Rating	UL 62275 Type	Pkg. Qty.	Installation Tools
-------------	-----------------	----------------	------------------------------	--	----------	-------	-----------------------	-------------------	---------------------------	---------------	-----------	--------------------

### Miniature Cross Section

PLT1M-C71	4.0 (102)	0.098 (2.5)	0.87 (22)	35 (1456)	Polyetheretherketone	Translucent	Chemical, Radiation and High Heat Resistant	—	V-0	—	100	GTS-E, PTS
PLT1.5M-C71	5.9 (150)											

### Standard Cross Section

PLT2S-C71	7.4 (188)	0.190 (4.8)	1.88 (48)	150 (668)	Polyetheretherketone	Translucent	Chemical, Radiation and High Heat Resistant	—	V-0	—	100	GTS-E, GS2B-E, GTH-E, GS4H-E, PTS, PTH, PPTS, STS2,STH2
-----------	-----------	-------------	-----------	-----------	----------------------	-------------	---	---	-----	---	-----	---

## Cable Tie Mount – PEEK (Polyetheretherketone)

- Unique cradle design provides maximum stability for cable bundle
- Low profile design keeps bundle close to mounting surface where overhead space is limited

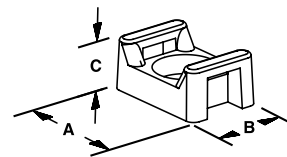

Part Number	Used with Cable Ties*	A Length In. (mm)	B Width In. (mm)	C Height In. (mm)	Counterbore Diameter In. (mm)	Mounting Method	Std. Pkg. Qty.	Std. Ctn. Qty.
TM2S8-C71	Minimum, Standard	0.636 (16.2)	0.427 (10.8)	0.278 (7.1)	0.335 (8.5)	#8 (M4) screw	100	500

- Product Showcase
- Abrasion Protection
- Cable Cleats
- Cable Ties
- Cable Tie Accessories
- Cable Tie Tools
- Identification Products
- Power Connectors
- Grounding Connectors
- Safety Solutions
- Stainless Steel Ties
- Terminals
- Wiring Duct
- Part Number Index

### Locking Tie Cable Ties – Metal Detectable Nylon 6.6 and Polypropylene

- Metal impregnated material allows identification by metal detector inspection equipment to help meet food, beverage, and pharmaceutical safety standards, to help reduce product contamination, loss, and recall
- Nylon material for general purpose maintenance and repair applications; ideal for use in control panels and overhead cable runs
- Polypropylene material provides excellent chemical resistance for use in processing and packaging areas where aggressive acid and alkaline chemicals are used to clean the equipment
- One-piece construction for consistent performance and reliability
- Among the lowest threading force of any one-piece cable tie in the industry
- Curved tip is easy to pick up from flat surfaces and allows faster initial threading to speed installation
- Material temperature for Nylon 6.6 is 185°F (85°C)
- Material temperature for Polypropylene 239°F (115°C)

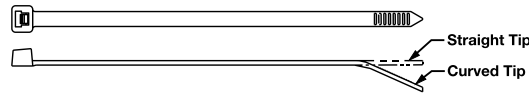

Part Number	Length In. (mm)	Width In. (mm)	Max Bundle Dia. In. (mm)	Minimum Loop Tensile Strength Lbs. (N)	Material	Color	Resistance Properties	AH-2 Plenum Rated	UL 94 Flammability Rating	UL 62275 Type	Pkg. Qty.	Installation Tools
-------------	-----------------	----------------	--------------------------	--	----------	-------	-----------------------	-------------------	---------------------------	---------------	-----------	--------------------

#### Miniature Cross Section

<b>PLT1M-C86</b>	3.9 (100)	0.098 (2.5)	.87 (22)	18 (80)	Metal Impregnated Nylon 6.6	Light Blue	—	—	HB	—	100	GTS-E, GS2B-E, STS2
<b>PLT1M-C186</b>				15 (67)	Metal Impregnated Polypropylene	Dark Blue	Chemical Resistant					

#### Intermediate Cross Section

<b>PLT2I-C86</b>	8.0 (203)	0.135 (3.4)	2.00 (51)	30 (133)	Metal Impregnated Nylon 6.6	Light Blue	—	—	HB	—	100	GTS-E, GS2B-E, STS2
<b>PLT2I-C186</b>				18 (80)	Metal Impregnated Polypropylene	Dark Blue	Chemical Resistant					

#### Standard Cross Section

<b>PLT2S-C86</b>	7.3 (186)	0.190 (4.8)	1.85 (47)	50 (222)	Metal Impregnated Nylon 6.6	Light Blue	—	—	HB	—	100	GTS-E, GS2B-E, GTH-E, GS4H-E, STS2, STH2
<b>PLT2S-C186</b>				30 (133)	Metal Impregnated Polypropylene	Dark Blue	Chemical Resistant					
<b>PLT3S-C186</b>	11.5 (291)	0.190 (4.8)	3.00 (76)	30 (133)	Metal Impregnated Polypropylene	Dark Blue	Chemical Resistant	—	HB	—	100	GTS-E, GS2B-E, GTH-E, GS4H-E, STS2, STH2
<b>PLT3S-C86</b>				50 (222)	Metal Impregnated Nylon 6.6	Light Blue	—					
<b>PLT4S-C86</b>	14.4 (366)	0.190 (4.8)	4.00 (102)	50 (222)	Metal Impregnated Nylon 6.6	Light Blue	—	—	HB	—	100	GTS-E, GS2B-E, GTH-E, GS4H-E, STS2, STH2
<b>PLT4S-C186</b>				30 (133)	Metal Impregnated Polypropylene	Dark Blue	Chemical Resistant					

#### Light-Heavy Cross Section (Straight Tip)

<b>PLT3H-L86</b>	11.1 (282)	0.300 (7.6)	3.00 (76)	120 (534)	Metal Impregnated Nylon 6.6	Light Blue	—	—	HB	—	50	GTH-E, GS4H-E, GS4EH-E, STH2, ST3EH
<b>PLT3H-L186</b>				60 (267)	Metal Impregnated Polypropylene	Dark Blue	Chemical Resistant					
<b>PLT4H-L86</b>	14.4 (366)	0.300 (7.6)	4.00 (102)	120 (534)	Metal Impregnated Nylon 6.6	Light Blue	—	—	HB	—	50	GTH-E, GS4H-E, GS4EH-E, STH2, ST3EH
<b>PLT4H-L186</b>				60 (267)	Metal Impregnated Polypropylene	Dark Blue	Chemical Resistant					

(continued on next page)

### Locking Tie Cable Ties – Metal Detectable Nylon 6.6 and Polypropylene *(continued)*

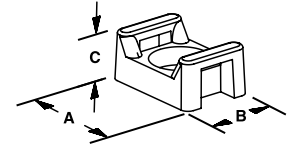

Part Number	Material	Used with Cable Ties*	A Length In. (mm)	B Width In. (mm)	C Height In. (mm)	Counterbore Diameter In. (mm)	Mounting Method	Std. Pkg. Qty.	Std. Ctn. Qty.
<b>Cable Tie Mounts</b>									
TM2S8-C86	Nylon 6.6	Min., Int., Std.	0.630 (16.0)	0.422 (10.7)	0.275 (7.0)	0.325 (8.3)	#8 (M4) screw	100	500
TM3S8-C86		Std., Lt. Hvy.	0.867 (22.0)	0.614 (15.6)	0.373 (9.5)		#10 (M5) screw		
TM3S10-C86									
TM2S8-C186	Polypropylene	Min., Int., Std.	0.630 (16.0)	0.422 (10.7)	0.275 (7.0)		#8 (M4) screw		
TM3S8-C186		Std., Lt. Hvy.	0.867 (22.0)	0.614 (15.6)	0.373 (9.5)		#10 (M5) screw		
TM3S10-C186									

### **Locking Tie Releasable Cable Tie – Nylon 6.6**

- For high temperature applications up to 185°F (85°C) – indoor use
- Extended release tab permits easy release and re-use where changes are anticipated during development, production, or servicing in the field
- One-piece construction for consistent performance and reliability
- Curved tip is easy to pick up from flat surfaces and allows faster initial threading to speed installation

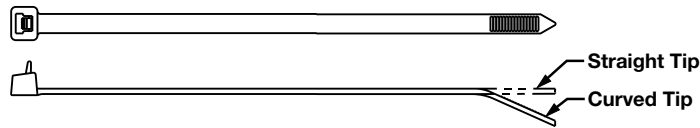
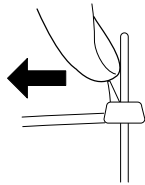

To release, grasp the head of the cable tie, deflect release tab, and pull the cable tie away from the bundle.

#### Standard Cross Section

Part Number	Length In. (mm)	Width In. (mm)	Max Bundle Diameter In. (mm)	Minimum Loop Tensile Strength Lbs. (N)	Material	Color	Resistance Properties	AH-2 Plenum Rated	UL 94 Flammability Rating	UL 62275 Type	Pkg. Qty.	Installation Tools
PRT4S-C	14.5 (368)	0.190 (4.8)	4.00 (102)	50 (222)	Nylon 6.6	Natural	—	✓	V2	2, 21, 2S, 21S	100	Hand install only



**Like what you see and want more?**

Visit [www.panduit.com](http://www.panduit.com) for the full offering of Panduit products





### Locking Tie Releasable Lashing Ties – Weather Resistant and Heat Stabilized Nylon 6.6

- Weather resistant material has greater resistance to damage caused by ultraviolet light – indoor or outdoor use
- Weather resistant up to 185°F (85°C)
- Heat stabilized material for high temperature applications up to 239°F (115°C) – indoor use
- Release tab permits easy release and re-use where changes are anticipated during development, production, or servicing in the field
- Typically used for heavy duty applications
- Among the strongest Panduit locking tie cable tie available
- Can be used with MCEH mounting clip

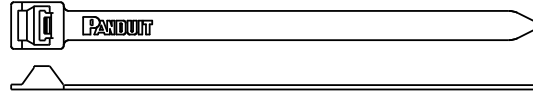

#### Extra-Heavy Cross Section

Part Number	Length In. (mm)	Width In. (mm)	Max Bundle Diameter In. (mm)	Minimum Loop Tensile Strength Lbs. (N)	Material	Color	Resistance Properties	AH-2 Plenum Rated	UL 94 Flammability Rating	UL 62275 Type	Pkg. Qty.	Installation Tools
<b>PRT5EH-Q0</b>	20.1 (511)	0.500 (12.7)	5.00 (127)	250 (1112)	Weather Resistant Nylon 6.6	Black	UV Resistant	—	V-2	1, 11	25	Hand install only
Heat Resistant							—			100		
<b>PRT5EH-C0</b>							1, 11			25		
<b>PRT6EH-Q0</b>	22.2 (564)	0.500 (12.7)	6.00 (152)	250 (1112)	Weather Resistant Nylon 6.6	Black	UV Resistant	—	V-2	1, 11	25	Hand install only
<b>PRT8EH-Q0</b>	28.3 (719)		8.00 (203)				1, 11					

\*PRT5EH-C30 not UL or CSA certified

### Locking Tie Releasable Lashing Ties – Weather Resistant Polypropylene

- For chemical resistance where high loop tensile strength is not required especially in the presence of hydrochloric acid, salts, and bases
- Greater resistance to damage caused by ultraviolet light – indoor or outdoor use
- Temperature rating is 239°F (115°C)
- Release tab permits easy release and re-use where changes are anticipated during development, production, or servicing in the field
- Typically used for heavy duty applications
- Can be used with MCEH mounting clip

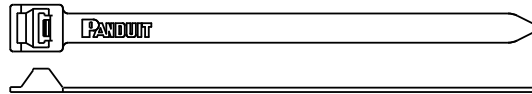

#### Extra-Heavy Cross Section

Part Number	Length In. (mm)	Width In. (mm)	Max Bundle Diameter In. (mm)	Minimum Loop Tensile Strength Lbs. (N)	Material	Color	Resistance Properties	AH-2 Plenum Rated	UL 94 Flammability Rating	UL 62275 Type	Pkg. Qty.	Installation Tools
<b>PRT2EH-C100</b>	9.0 (229)	0.500 (12.7)	2.00 (51)	90 (400)	Weather Resistant Polypropylene	Black	Chemical and UV Resistant	—	HB	—	100	Hand install only
<b>PRT5EH-C100</b>	20.1 (511)		5.00 (127)									
<b>PRT6EH-C100</b>	22.2 (564)		6.00 (152)									
<b>PRT8EH-C100</b>	28.3 (719)		8.00 (203)									



### Locking Tie Clamp Ties – Nylon 6.6

- For high temperature applications up to 185°F (85°C) – indoor use
- Used to secure a cable bundle to another surface such as a control panel, communication rack, wall or ceiling
- Design allows for bundling before or after screwing clamp in place
- One-piece construction for consistent performance and reliability
- Curved tip is easy to pick up from flat surfaces and allows faster initial threading to speed installation
- UL Listed for use in plenum or air handling spaces per NEC

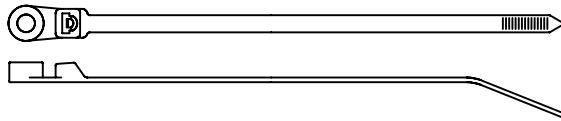

Part Number	Length In. (mm)	Width In. (mm)	Max Bundle Diameter In. (mm)	Minimum Loop Tensile Strength Lbs. (N)	Material	Color	Resistance Properties	AH-2 Plenum Rated	UL 94 Flammability Rating	UL 62275 Type	Pkg. Qty.	Installation Tools
<b>Miniature Cross Section</b>												
<b>PLC1M-S4-C</b>	4.3 (109)	0.100 (2.5)	.75 (19)	18 (80)	Nylon 6.6	Natural	—	✓	V2	2, 21	100	GTS-E, GS2B-E
<b>Standard Cross Section</b>												
<b>PLC2S-S10-C</b>	7.9 (201)	0.190 (4.8)	1.84 (47)	50 (222)	Nylon 6.6	Natural	—	✓	V2	2, 21	100	GTS-E, GS2B-E, GTH-E, GS4H-E
<b>PLC3S-S10-C</b>	12.0 (305)		3.00 (76)									



**Like what you see and want more?**

Visit [www.panduit.com](http://www.panduit.com) for the full offering of Panduit products



### Locking Tie Clamp Ties – Weather Resistant and Heat Stabilized Nylon 6.6

- Weather resistant material has greater resistance to damage caused by ultraviolet light – indoor or outdoor use
- Weather resistant temperature is 185°F (85°C)
- Heat stabilized material for high temperature applications up to 239°F (115°C) – indoor use
- Used to secure a cable bundle to another surface such as a control panel, communication rack, wall or ceiling
- Design allows for bundling before or after screwing clamp in place
- One-piece construction for consistent performance and reliability
- Curved tip is easy to pick up from flat surfaces and allows faster initial threading to speed installation

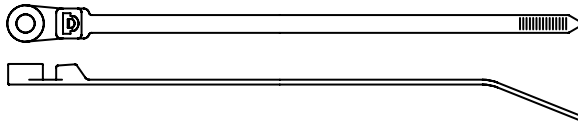

Part Number	Length In. (mm)	Width In. (mm)	Max Bundle Diameter In. (mm)	Minimum Loop Tensile Strength Lbs. (N)	Material	Color	Resistance Properties	AH-2 Plenum Rated	UL 94 Flammability Rating	UL 62275 Type	Pkg. Qty.	Installation Tools
<b>Standard Cross Section</b>												
PLC2S-S6-C0	7.9 (201)	0.190 (4.8)	1.84 (47)	50 (222)	Weather Resistant Nylon 6.6	Black	UV Resistant	—	V2	1, 11	100	GTS-E, GS2B-E, GTH-E, GS4H-E
PLC2S-S10-C0	15.0 (381)		4.00 (102)				Heat Resistant					
PLC4S-S10-C0	7.9 (201)		1.84 (47)		Heat Resistant		1000					
PLC2S-S10-M30	7.9 (201)		1.84 (47)		Heat Resistant		1000					
<b>Light-Heavy Cross Section</b>												
PLC2H-S25-TL0	9.0 (229)	0.300 (7.6)	2.00 (51)	120 (534)	Weather Resistant Nylon 6.6	Black	UV Resistant	—	V2	1, 11	250	GTH-E, GS4H-E, GS4EH-E



Like what you see and want more?

Visit [www.panduit.com](http://www.panduit.com) for the full offering of Panduit products



### Locking Tie Wing Push Mount Tie – Nylon 6.6

- For high temperature applications up to 185°F (85°C) – indoor use
- Cable tie, mount, and fastener in a single part
- Used to attach bundles to another surface such as a flat panel
- Anchor is easily pressed into a pre-formed hole and locks in place
- Wings provide constant tension for a stable, secure, and rattle-free installation
- Curved tip is easy to pick up from flat surfaces and allows faster initial threading to speed installation

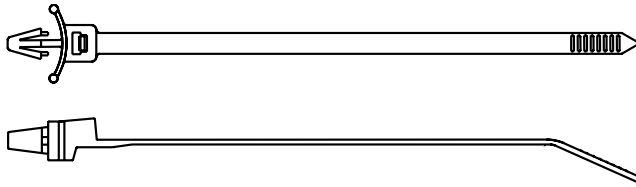

#### Standard Cross Section

Part Number	Length In. (mm)	Width In. (mm)	Max Bundle Diameter In. (mm)	Minimum Loop Tensile Strength Lbs. (N)	Material	Color	Resistance Properties	AH-2 Plenum Rated	UL 94 Flammability Rating	UL 62275 Type	Pkg. Qty.	Installation Tools
PLWP1SB-D	5.2 (132)	0.190 (4.8)	1.00 (25)	50 (222)	Nylon 6.6	Natural	—	—	V2	1, 11	500	GTS-E, GS2B-E, GTH-E, GS4H-E, PTS, PTH, PPTS, STS2, STH2



**Like what you see and want more?**

Visit [www.panduit.com](http://www.panduit.com) for the full offering of Panduit products



### Locking Tie Wing Push Mount Ties – Heat Stabilized Nylon 6.6

- Heat stabilized material for high temperature applications up to 239°F (115°C) – indoor use
- Cable tie, mount, and fastener in a single part
- Used to attach bundles to another surface such as a flat panel
- Anchor is easily pressed into a pre-formed hole and locks in place
- Wings provide constant tension for a stable, secure, and rattle-free installation
- Curved tip is easy to pick up from flat surfaces and allows faster initial threading to speed installation

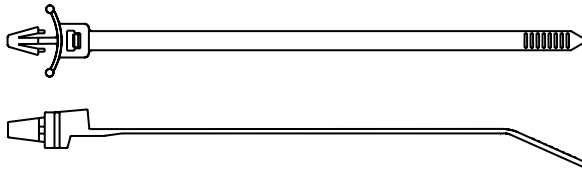

#### Miniature Cross Section

Part Number	Length In. (mm)	Width In. (mm)	Max Bundle Diameter In. (mm)	Minimum Loop Tensile Strength Lbs. (N)	Material	Color	Resistance Properties	AH-2 Plenum Rated	UL 94 Flammability Rating	UL 62275 Type	Pkg. Qty.	Installation Tools
PLWP1M-D30	4.3 (109)	0.098 (2.5)	.87 (22)	18 (80)	Heat Stabilized Nylon 6.6	Black	Heat Resistant	—	V2	1, 11	500	GTS-E, GS2B-E, PTS, PPTS, STS2

#### Standard Cross Section

PLWP1S-D30	5.2 (132)	0.190 (4.8)	1.00 (25)	50 (222)	Heat Stabilized Nylon 6.6	Black	Heat Resistant	—	V2	1, 11	500	GTS-E, GS2B-E, GTH-E, GS4H-E, PTS, PTH, PPTS, STS2, STH2
------------	-----------	-------------	-----------	----------	---------------------------	-------	----------------	---	----	-------	-----	--



**Like what you see and want more?**

Visit [www.panduit.com](http://www.panduit.com) for the full offering of Panduit products





### Locking Tie Releasable Wing Push Mount Ties

- Natural nylon material for indoor use
- Weather resistant material has greater resistance to damage caused by ultraviolet light – indoor or outdoor use
- Weather resistant temperature is 185°F (85°C)
- Cable tie, mount, and fastener in a single part
- Used to attach bundles to another surface such as a flat panel
- Anchor is easily pressed into a pre-formed hole and locks in place
- Wings provide constant tension for a stable, secure, and rattle-free installation

- Extended release tab permits easy release and re-use where changes are anticipated during development, production, or servicing in the field
- Curved tip is easy to pick up from flat surfaces and allows faster initial threading to speed installation



PRWP1.5S-D



PRWP1.5S-D0

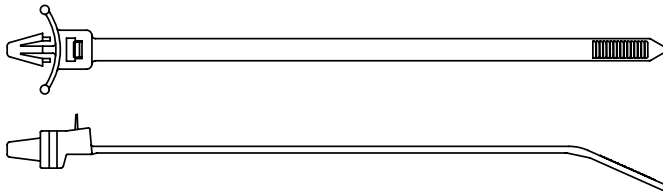

#### Standard Cross Section

Part Number	Length In. (mm)	Width In. (mm)	Max Bundle Diameter In. (mm)	Minimum Loop Tensile Strength Lbs. (N)	Material	Color	Resistance Properties	AH-2 Plenum Rated	UL 94 Flammability Rating	UL 62275 Type	Pkg. Qty.	Installation Tools
PRWP1.5S-D	6.8 (173)	0.190 (4.8)	1.50 (38)	50 (222)	Nylon 6.6	Natural	—	—	—	1, 11	500	Hand install only
PRWP1.5S-D0					Weather Resistant Nylon 6.6	Black	UV Resistant					



**Like what you see and want more?**

Visit [www.panduit.com](http://www.panduit.com) for the full offering of Panduit products

### Locking Tie Push Mount Ties

- Natural nylon material for indoor use
- Weather resistant material has greater resistance to damage caused by ultraviolet light – indoor or outdoor use
- Weather resistant temperature is 185°F (85°C)
- *Wingless* design allows tie to be used in confined spaces
- Cable tie, mount, and fastener in a single part
- Economical push mount ties are used to attach bundles to another surface such as a flat panel
- Anchor is easily pressed into a pre-formed hole and locks in place
- Curved tip is easy to pick up from flat surfaces and allows faster initial threading to speed installation

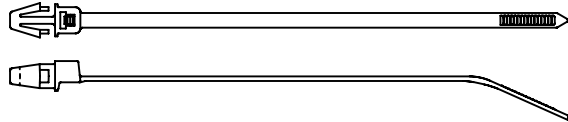

PLP1S-M

PLP2S-M0

#### Standard Cross Section

Part Number	Length In. (mm)	Width In. (mm)	Max Bundle Diameter In. (mm)	Minimum Loop Tensile Strength Lbs. (N)	Material	Color	Resistance Properties	AH-2 Plenum Rated	UL 94 Flammability Rating	UL 62275 Type	Pkg. Qty.	Installation Tools
PLP1S-M	5.3 (135)	0.190 (4.8)	1.00 (25)	50 (222)	Nylon 6.6	Natural	—	—	V2	1, 11	1000	GTS-E, GS2B-E, GTH-E, GS4H-E, PTS, PTH, PPTS, STS2, STH2
PLP2S-M0	7.9 (200)		1.75 (45)		Weather Resistant Nylon 6.6	Black	UV Resistant					



**Like what you see and want more?**

Visit [www.panduit.com](http://www.panduit.com) for the full offering of Panduit products

### UL US CS Locking Tie Marker and Flag Ties

- Natural and weather resistant material temperatures is 185° F (85° C) – indoor use
- Natural nylon material for indoor use
- Weather resistant material has greater resistance to damage caused by ultraviolet light – indoor or outdoor use
- Used to fasten and identify bundles at the same time
- One-piece construction for consistent performance and reliability
- Can be marked with marker pens or computer printable labels
- Curved tip is easy to pick up from flat surfaces and allows faster initial threading to speed installation

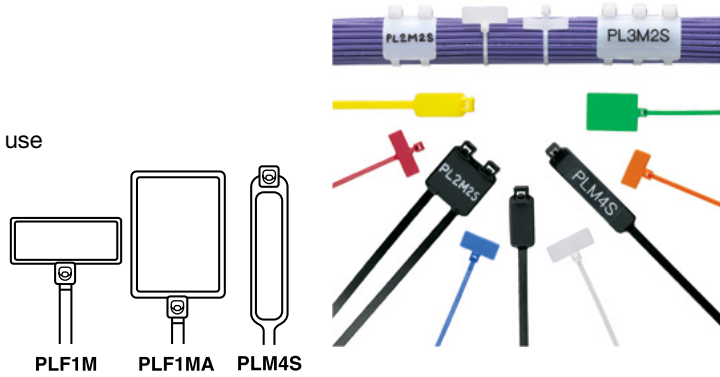

Part Number	Marker Type	Length		Width		Thickness		Marker Write-On Area		Max Bundle Diameter		Minimum Loop Tensile Strength Lbs. (N)	Recommended Installation Tool	Std. Pkg. Qty.	Std. Ctn. Qty.
		In.	mm	In.	mm	In.	mm	In.	mm	In.	mm				
<b>Miniature Cross Section</b>															
PLF1M-C	Flag	4.3	109	0.098	2.5	0.045	1.1	0.31 x 0.75	7.9 x 19.1	0.87	22	18 (80)	GTS-E, GS2B-E, PTS, PPTS, STS2	100	1000
PLF1MA-C		5.1	130					0.76 x 1.04	19.1 x 26.4						
<b>Standard Cross Section</b>															
PLM4S-DO	Wrap	14.6	371	0.185	4.7	0.052	1.3	0.44 x 2.00	11.1 x 50.8	4.00	102	50 (222)	GTS-E, GS2B-E, GTH-E, GS4H-E, PTH, PPTS, STS2, STH2	500	5000



**Like what you see and want more?**

Visit [www.panduit.com](http://www.panduit.com) for the full offering of Panduit products

- Product Showcase
- Abrasion Protection
- Cable Cleats
- Cable Ties
- Cable Tie Accessories
- Cable Tie Tools
- Identification Products
- Power Connectors
- Grounding Connectors
- Safety Solutions
- Stainless Steel Ties
- Terminals
- Wiring Duct
- Part Number Index



### Dome-Top® Barb Ty Cable Ties – Nylon 6.6

- For temperature applications up to 185°F (85°C) – indoor use
- Dome-top head features unique patented design with round, smooth edges
- Stainless steel locking barb provides consistent performance, reliability, and infinite adjustability through entire bundle range
- High strength and low thread force
- A variety of materials and colors are available for specific applications
- Curved tip is easy to pick up from flat surfaces and allows faster initial threading to speed installation
- UL Listed for use in plenum or air handling spaces per NEC

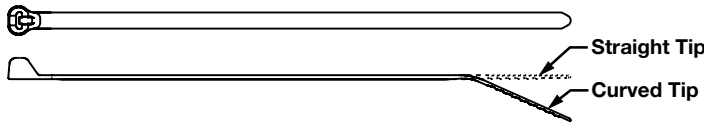

Part Number	Length In. (mm)	Width In. (mm)	Max Bundle Diameter In. (mm)	Minimum Loop Tensile Strength Lbs. (N)	Material	Color	Resistance Properties	AH-2 Plenum Rated	UL 94 Flammability Rating	UL 62275 Type	Pkg. Qty.	Installation Tools
-------------	-----------------	----------------	------------------------------	--	----------	-------	-----------------------	-------------------	---------------------------	---------------	-----------	--------------------

#### Miniature Cross Section

<b>BT1M-C</b>	4.0 (102)	0.095 (2.4)	0.90 (23)	18 (80)	Nylon 6.6	Natural	—	✓	V2	2, 21	100	GTS-E, GS2B-E, PTS, PPTS, STS2
---------------	-----------	-------------	-----------	---------	-----------	---------	---	---	----	-------	-----	--------------------------------

#### Intermediate Cross Section

<b>BT1.5I-C</b>	6.1 (155)	0.141 (3.6)	1.50 (38)	40 (178)	Nylon 6.6	Natural	—	✓	V2	2, 21	100	GTS-E, GS2B-E, PTS, PPTS, STS2
<b>BT2I-C</b>	8.0 (203)		2.00 (51)									
<b>BT3I-C</b>	11.3 (287)		3.00 (76)									

#### Standard Cross Section

<b>BT2S-C</b>	8.0 (203)	0.185 (4.7)	2.00 (51)	50 (222)	Nylon 6.6	Natural	—	✓	V2	2, 21, 2S, 21S	100	GTS-E, GS2B-E, GTH-E, GS4H-E, PTS, PTH, PPTS, STS2, STH2
<b>BT3S-C</b>	12.0 (305)		3.00 (76)									
<b>BT4S-C</b>	15.1 (384)		4.00 (102)									
<b>BT4S-M</b>											1000	

#### Light-Heavy Cross Section (Straight Tip)

<b>BT4LH-L</b>	14.9 (378)	0.275 (7.0)	4.00 (102)	120 (534)	Nylon 6.6	Natural	—	✓	V2	2, 21, 2S, 21S	50	GTH-E, GS4H-E, GS4EH-E, PTH, STH2, ST3EH
<b>BT5LH-L</b>	18.1 (460)		5.00 (127)									
<b>BT7LH-L</b>	24.4 (620)		7.00 (178)									
<b>BT9LH-L</b>	30.7 (780)		9.00 (229)									

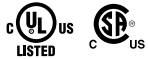

### Dome-Top® Barb Ty Cable Ties – Weather Resistant Nylon 6.6

- Greater resistance to damage caused by ultraviolet light – indoor or outdoor use
- Weather resistant temperature is 185°F (85°C)
- Dome-top head features unique patented design with round, smooth edges
- Stainless steel locking barb provides consistent performance, reliability, and infinite adjustability through entire bundle range
- High strength and low thread force
- Curved tip is easy to pick up from flat surfaces and allows faster initial threading to speed installation
- UL Listed for use in plenum or air handling spaces per NEC

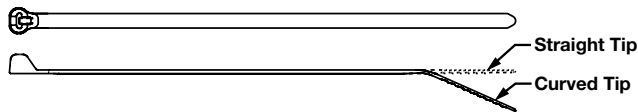

Part Number	Length In. (mm)	Width In. (mm)	Max Bundle Diameter In. (mm)	Minimum Loop Tensile Strength Lbs. (N)	Material	Color	Resistance Properties	AH-2 Plenum Rated	UL 94 Flammability Rating	UL 62275 Type	Pkg. Qty.	Installation Tools
-------------	-----------------	----------------	------------------------------	--	----------	-------	-----------------------	-------------------	---------------------------	---------------	-----------	--------------------

#### Miniature Cross Section

BT1M-C0	4.0 (102)	0.095 (2.4)	0.90 (23)	18 (80)	Weather Resistant Nylon 6.6	Black	UV Resistant	✓	V2	2, 21	100	GTS-E, GS2B-E, PTS, PPTS, STS2
BT1.5M-C0	6.3 (160)		1.50 (38)									
BT2M-C0	7.9 (201)		2.00 (51)									

#### Intermediate Cross Section

BT1.5I-C0	6.1 (155)	0.141 (3.6)	1.50 (38)	40 (178)	Weather Resistant Nylon 6.6	Black	UV Resistant	✓	V-2	2, 21	100	GTS-E, GS2B-E, PTS, PPTS, STS2
BT2I-C0	8.0 (203)		2.00 (51)									
<b>BEST SELLER</b> BT3I-C0	11.3 (287)		3.00 (76)									
BT4I-C0	14.3 (363)		4.00 (102)									

#### Standard Cross Section

<b>BEST SELLER</b> BT2S-C0	8.0 (203)	0.185 (4.7)	2.00 (51)	50 (222)	Weather Resistant Nylon 6.6 Weather	Black	UV Resistant	✓	V-2	2, 21, 2S, 21S	100	GTS-E, GS2B-E, GTH-E, GS4H-E, PTS, PTH, PPTS, STS2, STH2										
<b>BEST SELLER</b> BT2S-M0			1000																			
<b>BEST SELLER</b> BT3S-C0	12.0 (305)	0.185 (4.7)	3.00 (76)	50 (222)	Weather Resistant Nylon 6.6 Weather	Black	UV Resistant	✓	V-2	2, 21, 2S, 21S	100											
<b>BEST SELLER</b> BT3S-M0											1000											
<b>BEST SELLER</b> BT4S-C0											15.1 (384)		0.185 (4.7)	4.00 (102)	50 (222)	Weather Resistant Nylon 6.6 Weather	Black	UV Resistant	✓	V-2	2, 21, 2S, 21S	100
<b>BEST SELLER</b> BT4S-M0																						1000

(continued on next page)

- Product Showcase
- Abrasion Protection
- Cable Cleats
- Cable Ties
- Cable Tie Accessories
- Cable Tie Tools
- Identification Products
- Power Connectors
- Grounding Connectors
- Safety Solutions
- Stainless Steel Ties
- Terminals
- Wiring Duct
- Part Number Index



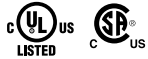

### Dome-Top® Barb Ty Cable Ties – Weather Resistant Nylon 6.6 (continued)

Part Number	Length In. (mm)	Width In. (mm)	Max Bundle Diameter In. (mm)	Minimum Loop Tensile Strength Lbs. (N)	Material	Color	Resistance Properties	AH-2 Plenum Rated	UL 94 Flammability Rating	UL 62275 Type	Pkg. Qty.	Installation Tools
<b>Light-Heavy Cross Section (Straight Tip)</b>												
BT2LH-L0	8.7 (221)	0.275 (7.0)	2.00 (51)	120 (534)	Weather Resistant Nylon 6.6	Black	UV Resistant	✓	V-2	2, 21, 2S, 21S	50	GTH-E, GS4H-E, GS4EH-E, PTH, STH2, ST3EH
BT3LH-L0	11.8 (300)		3.00 (76)									
<b>BEST SELLER</b> BT4LH-L0	14.9 (378)		4.00 (102)									
<b>BEST SELLER</b> BT4LH-TL0			5.00 (127)									
<b>BEST SELLER</b> BT5LH-L0	18.1 (460)		7.00 (178)									
<b>BEST SELLER</b> BT5LH-C0			9.00 (229)									
BT7LH-L0	24.4 (620)		250									
BT9LH-L0	30.7 (780)		50									



**Like what you see and want more?**

Visit [www.panduit.com](http://www.panduit.com) for the full offering of Panduit products



### Dome-Top® Barb Ty Cable Ties – Heat Stabilized Nylon 6.6

- For high temperature applications up to 239°F (115°C) – indoor use
- Dome-top head features unique patented design with round, smooth edges
- Stainless steel locking barb provides consistent performance, reliability, and infinite adjustability through entire bundle range
- Curved tip is easy to pick up from flat surfaces and allows faster initial threading to speed installation

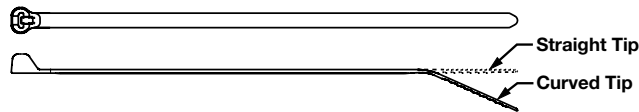

BT2S-M30



BT2S-M39

Part Number	Length In. (mm)	Width In. (mm)	Max Bundle Diameter In. (mm)	Minimum Loop Tensile Strength Lbs. (N)	Material	Color	Resistance Properties	AH-2 Plenum Rated	UL 94 Flammability Rating	UL 62275 Type	Pkg. Qty.	Installation Tools
-------------	-----------------	----------------	------------------------------	--	----------	-------	-----------------------	-------------------	---------------------------	---------------	-----------	--------------------

#### Miniature Cross Section

BT2M-M30	7.9 (201)	0.095 (2.4)	2.00 (51)	18 (80)	Heat Stabilized Nylon 6.6	Black	Heat Resistant	–	V2	2, 21	1000	GTS-E, GS2B-E, PTS, PPTS, STS2
----------	-----------	-------------	-----------	---------	---------------------------	-------	----------------	---	----	-------	------	--------------------------------

#### Intermediate Cross Section

BT1.5I-M30	6.1 (155)	0.141 (3.6)	1.50 (38)	40 (178)	Heat Stabilized Nylon 6.6	Black	Heat Resistant	–	V2	2, 21	1000	GTS-E, GS2B-E, PTS, PPTS, STS2
BT3I-M30	11.3 (287)		3.00 (76)									

#### Standard Cross Section

BT2S-M30	8.0 (203)	0.185 (4.7)	2.00 (51)	50 (222)	Heat Stabilized Nylon 6.6	Black	Heat Resistant	–	V2	2, 21	1000	GTS-E, GS2B-E, GTH-E, GS4H-E, PTS, PTH, PPTS, STS2, STH2
BT2S-M39						Natural						
BT4S-M30	15.1 (384)		4.00 (102)			Black						

- Product Showcase
- Abrasion Protection
- Cable Cleats
- Cable Ties
- Cable Tie Accessories
- Cable Tie Tools
- Identification Products
- Power Connectors
- Grounding Connectors
- Safety Solutions
- Stainless Steel Ties
- Terminals
- Wiring Duct
- Part Number Index



### Dome-Top® Barb Ty Clamp Tie – Nylon 6.6

- For temperature applications up to 185°F (85°C) – indoor use
- Used to secure a cable bundle to another surface such as a control panel, communication rack, wall or ceiling
- Design allows for bundling before or after screwing clamp in place

- Stainless steel locking barb provides consistent performance, reliability, and infinite adjustability through entire bundle range
- Curved tip is easy to pick up from flat surfaces and allows faster initial threading to speed installation
- UL Listed for use in plenum or air handling spaces per NEC

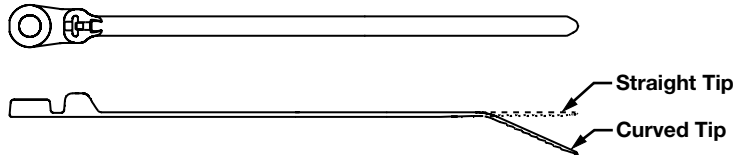

#### Standard Cross Section

Part Number	Length In. (mm)	Width In. (mm)	Max Bundle Diameter In. (mm)	Minimum Loop Tensile Strength Lbs. (N)	Material	Color	Resistance Properties	AH-2 Plenum Rated	UL 94 Flammability Rating	UL 62275 Type	Pkg. Qty.	Installation Tools
BC2S-S10-C	8.5 (216)	0.185 (4.7)	2.00 (51)	50 (222)	Nylon 6.6	Natural	—	✓	V2	2, 21	100	GTS-E, GS2B-E, GTH-E, GS4H-E



### Dome-Top® Barb Ty Clamp Tie – Weather Resistant

- Weather Resistant material has greater resistance to damage caused by ultraviolet light – indoor or outdoor use
- Weather resistant temperature is 185°F (85°C)
- Used to secure a cable bundle to another surface such as a control panel, communication rack, wall or ceiling
- Design allows for bundling before or after screwing clamp in place

- Stainless steel locking barb provides consistent performance, reliability, and infinite adjustability through entire bundle range
- Curved tip is easy to pick up from flat surfaces and allows faster initial threading to speed installation

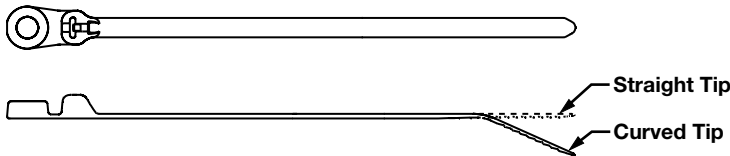

#### Light-Heavy Cross Section (Straight Tip)

Part Number	Length In. (mm)	Width In. (mm)	Max Bundle Diameter In. (mm)	Minimum Loop Tensile Strength Lbs. (N)	Material	Color	Resistance Properties	AH-2 Plenum Rated	UL 94 Flammability Rating	UL 62275 Type	Pkg. Qty.	Installation Tools
BC4LH-S25-L0	15.5 (394)	0.275 (7.0)	4.00 (102)	120 (534)	Weather Resistant Nylon 6.6	Black	UV Resistant	—	V2	1, 11	50	GTH-E, GS4H-E, GS4EH-E

## Dura-Ty™ Cable Ties – Weather Resistant Acetal – Heavy Cross Section

- Acetal strap and head materials can provide 20 years + life in outdoor applications. Factors such as installation procedures, tooling and environmental conditions can influence the actual life
- Excellent ultraviolet light, chemical, and moisture resistance
- Double stainless steel locking barbs provide consistent and predictable holding values
- Textured strap provides better gripping surface to prevent tie from moving laterally along the length of the bundle for tight, consistent bundles
- Robust head design allows tie to be tightened over a wide range of angles
- Convenient reel dispenser pack allows installer to cut-to-size for customized field applications; recyclable box has through-hole for attaching to belt, plus storage area for bag of heads
- Ideal for securing cables in outdoor messenger strand applications
- May be used with stackable aerial cable spacer, part number [SACS50-T100](#)
- For high temperature applications up to 185°F (85°C)



Part Number	Description	Strap Length		Strap Width		Min. Loop Tensile Str.		Head Height		Head Width		Recommended Installation Tool	Std. Pkg. Qty.	Std. Ctn. Qty.
		Ft.	mm	In.	mm	lbs.	N	In.	mm	In.	mm			

### Strapping, Heads, and Kit – Allows user to customize strap length

<a href="#">DTRH-LR0</a>	50' reel of strapping	50.0	15,240	0.331	8.40	200	890	–	–	–	–	<a href="#">GTH-E, GS4EH-E, STH2, STHV</a>	1	20
<a href="#">DTHH-Q0</a>	25 cable tie heads	–	–	–	–	–	–	0.393	9.98	0.557	14.15	–	25	500

## Dura-Ty™ Cable Ties – Weather Resistant Acetal – Extra-Heavy Cross Section

Formula to determine amount of strapping required:  
 Diameter (inches) x 3.14 + 4.5 inches  
 Diameter (mm) x 3.14 + 114mm



Part Number	Description	Strap Length		Strap Width		Min. Loop Tensile Str.		Head Height		Head Width		Recommended Installation Tool	Std. Pkg. Qty.	Std. Ctn. Qty.
		Ft.	mm	In.	mm	lbs.	N	In.	mm	In.	mm			

### Strapping, Heads, and Kit – Allows user to customize strap length

<a href="#">DTREH-LR0</a>	50' reel of strapping	50.0	15,240	0.500	12.70	250	1112	–	–	–	–	<a href="#">GS4EH-E</a>	1	20
<a href="#">DTHEH-Q0</a>	25 cable tie heads	–	–	–	–	–	–	0.490	12.45	0.718	18.24	–	25	500
<a href="#">DTKEH-0</a>	Kit: Strapping (50'), Heads (25)	50.0	15,240	0.500	12.70	250	1112	–	–	–	–	<a href="#">GS4EH-E</a>	1	20

Part Number	Length		Width		Thickness		Nominal Hole Dia.		Max. Panel Thickness		Max Bundle Dia.		Min. Loop Tensile Str.		Recommended Installation Tool	Std. Pkg. Qty.	Std. Ctn. Qty.
	In.	mm	In.	mm	In.	mm	In.	mm	In.	mm	In.	mm	lbs.	N			

### Discrete Lengths – Speed Installation

<a href="#">DT4EH-L0</a>	13.5	343	0.500	12.70	0.059	1.50	0.490	12.45	0.718	18.24	3.8	98	250	1112	<a href="#">GS4EH-E</a>	50	1000
<a href="#">DT8EH-Q0</a>	27.0	686									8.0	203				25	500
<a href="#">DT14EH-L0</a>	48.0	1219									14.0	355				50	250
<a href="#">DT28EH-C0</a>	96.0	2438									28.0	711				100	–
<a href="#">DT44EH-C0</a>	144.0	3658									44.0	1117				100	–



### Contour-Ty® Cable Ties – Nylon 6.6

- For temperature applications up to 185°F (85°C) – indoor use
- Unique design prevents wire and cable damage
- Low profile head avoids snags and reduces overall bundle size
- Outside teeth and smooth round edges protect cable jacket – ideal for high vibration applications
- Parallel-entry limits exposure to sharp edges and protects workers' arms/hands
- Fully enclosed head for consistent strength
- Curved tip is easy to pick up from flat surfaces and allows faster initial threading to speed installation
- UL Listed for use in plenum or air handling spaces per NEC
- Nylon 6.6 cable ties in natural and colors meet the testing requirements of SAE Aerospace Standard AS23190 and the dimensional requirements of SAE Aerospace Standard AS33671

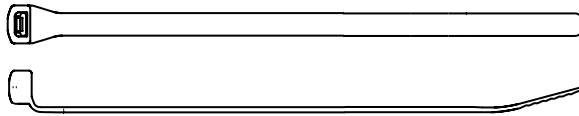

Part Number	Length In. (mm)	Width In. (mm)	Max Bundle Diameter In. (mm)	Minimum Loop Tensile Strength Lbs. (N)	Material	Color	Resistance Properties	AH-2 Plenum Rated	UL 94 Flammability Rating	UL 62275 Type	Pkg. Qty.	Installation Tools
-------------	-----------------	----------------	------------------------------	--	----------	-------	-----------------------	-------------------	---------------------------	---------------	-----------	--------------------

#### Miniature Cross Section

<b>CBR1M-M</b>	4.1 (104)	0.098 (2.5)	1.00 (25)	18 (80)	Nylon 6.6	Natural	—	✓	V-2	2, 21	1000	GTS-E, GS2B-E, PTS, PPTS, STS2
<b>CBR1.5M-M</b>	5.8 (147)		1.50 (38)									
<b>CBR2M-M</b>	7.3 (185)		2.00 (51)									

#### Intermediate Cross Section

<b>CBR3I-M</b>	10.4 (264)	0.140 (3.6)	3.00 (76)	40 (178)	Nylon 6.6	Natural	—	✓	V-2	2, 21	1000	GTS-E, GS2B-E, PTS, PPTS, STS2
----------------	------------	-------------	-----------	----------	-----------	---------	---	---	-----	-------	------	--------------------------------

#### Standard Cross Section

<b>CBR3S-M</b>	10.8 (274)	0.190 (4.8)	3.00 (76)	50 (222)	Nylon 6.6	Natural	—	✓	V-2	2, 21	1000	GTS-E, GS2B-E, GTH-E, GS4H-E, PTS, PTH, PPTS, STS2, STH2
<b>CBR4S-M</b>	14.0 (356)		4.00 (102)									





### Contour-Ty® Cable Ties – Weather Resistant Nylon 6.6

- Greater resistance to damage caused by ultraviolet light – indoor or outdoor use
- Unique design prevents wire and cable damage
- Low profile head avoids snags and reduces overall bundle size
- Outside teeth and smooth round edges protect cable jacket – ideal for high vibration applications
- Parallel-entry limits exposure to sharp edges and protects workers' arms/hands
- Fully enclosed head for consistent strength
- Curved tip is easy to pick up from flat surfaces and allows faster initial threading to speed installation
- Weather resistant temperature is 185°F (85°C)

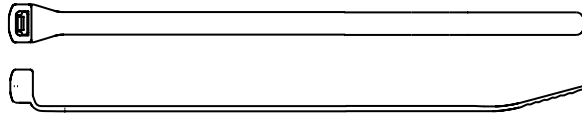

Part Number	Length In. (mm)	Width In. (mm)	Max Bundle Diameter In. (mm)	Minimum Loop Tensile Strength Lbs. (N)	Material	Color	Resistance Properties	AH-2 Plenum Rated	UL 94 Flammability Rating	UL 62275 Type	Pkg. Qty.	Installation Tools
-------------	-----------------	----------------	------------------------------	--	----------	-------	-----------------------	-------------------	---------------------------	---------------	-----------	--------------------

#### Miniature Cross Section

<b>CBR1M-M0</b>	4.1 (104)	0.098 (2.5)	1.00 (25)	18 (80)	Weather Resistant Nylon 6.6	Black	UV Resistant	✓	V-2	2, 21	1000	GTS-E, GS2B-E, PTS, PPTS, STS2
-----------------	-----------	-------------	-----------	---------	-----------------------------	-------	--------------	---	-----	-------	------	--------------------------------

#### Intermediate Cross Section

<b>CBR1.5I-M0</b>	5.9 (150)	0.140 (3.6)	1.50 (38)	40 (178)	Weather Resistant Nylon 6.6	Black	UV Resistant	—	V-2	2, 21	1000	GTS-E, GS2B-E, PTS, PPTS, STS2
-------------------	-----------	-------------	-----------	----------	-----------------------------	-------	--------------	---	-----	-------	------	--------------------------------

#### Standard Cross Section

<b>CBR2S-M0</b>	7.6 (193)	0.190 (4.8)	2.00 (51)	50 (222)	Weather Resistant Nylon 6.6	Black	UV Resistant	—	V-2	2, 21	1000	GTS-E, GS2B-E, GTH-E, GS4H-E, PTS, PTH, PPTS, STS2, STH2
<b>CBR3S-M0</b>	10.8 (274)		3.00 (76)					✓				
<b>CBR4S-M0</b>	14.0 (356)		4.00 (102)									



Like what you see and want more?

Visit [www.panduit.com](http://www.panduit.com) for the full offering of Panduit products



### Contour-Ty® Cable Tie – Heat Stabilized Nylon 6.6

- Heat stabilized material for high temperature applications up to 239°F (115°C) – indoor use
- Unique design prevents wire and cable damage
- Low profile head avoids snags and reduces overall bundle size
- Outside teeth and smooth round edges protect cable jacket – ideal for high vibration applications
- Parallel-entry limits exposure to sharp edges and protects workers’ arms/hands
- Fully enclosed head for consistent strength
- Curved tip is easy to pick up from flat surfaces and allows faster initial threading to speed installation

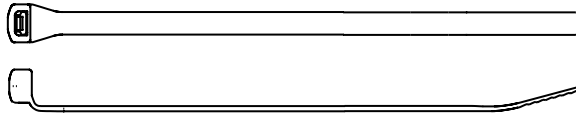

#### Standard Cross Section

Part Number	Length In. (mm)	Width In. (mm)	Max Bundle Diameter In. (mm)	Minimum Loop Tensile Strength Lbs. (N)	Material	Color	Resistance Properties	AH-2 Plenum Rated	UL 94 Flammability Rating	UL 62275 Type	Pkg. Qty.	Installation Tools
<b>CBR2S-M39</b>	7.6 (193)	0.190 (4.8)	2.00 (51)	50 (222)	Heat Stabilized Nylon 6.6	Natural	Heat Resistant	—	V-2	2, 21	1000	GTS-E, GS2B-E, GTH-E, GS4H-E, PTS, PTH, PPTS, STS2, STH2

### Hyper-V™ In-Line Cable Tie – Weather Resistant Nylon 6.6

- Fixed and flexible two-wedge locking design provides a low threading force
- Teeth on both sides of cable tie body provide additional locking strength and improved flexibility to conform to irregular bundle shapes such as securing cables to cable tray systems
- Releasable head position for temporary bundling of cables prior to final locking; no need to replace ties when adding cables/wires to the bundle
- Teeth on full length of body support a wide range of bundle diameters
- Bending serrations on the tip of the tie allow the tip to be easily formed into an arc, enabling installer to “fish” the tie around the bundle in a confined space
- Threading hole in the tip of the tie allows an installer to hook the tip with a simple device to pull the tie through spaces with limited access
- In-Line tie design for parallel-entry of the tie into head resulting in a lower profile on cable bundles
- Weather resistant temperature is 185°F (85°C)



Part Number	Length In. (mm)	Width In. (mm)	Max Bundle Diameter In. (mm)	Minimum Loop Tensile Strength Lbs. (N)	Material	Color	Resistance Properties	AH-2 Plenum Rated	UL 94 Flammability Rating	UL 62275 Type	Pkg. Qty.	Installation Tools
<b>HV9150-C0</b>	20.7 (525)	0.350 (8.9)	5.90 (150)	160 (710)	Weather Resistant Nylon 6.6	Black	UV Resistant	—	V2	—	100	GTH-E, GS4H-E, GS4EH-E, PTH, STH2, ST3EH, STHV



### Locking Tie Stud Mounted Cable Tie – Heat Stabilized Weather Resistant Nylon 6.6

- Heat stabilized weather resistant material has greater resistance to damage caused by ultraviolet light and for high temperature applications up to 239°F (115°C) – indoor or outdoor use
- Integral mount pushes onto a threaded stud and tie wraps around bundle
- Tie can be removed from the stud by turning counterclockwise
- Curved tip is easy to pick up from flat surfaces and allows faster initial threading to speed installation

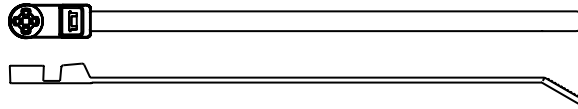

#### Light-Heavy Cross Section

Part Number	Length In. (mm)	Width In. (mm)	Max Bundle Diameter In. (mm)	Minimum Loop Tensile Strength Lbs. (N)	Material	Color	Resistance Properties	AH-2 Plenum Rated	UL 94 Flammability Rating	UL 62275 Type	Pkg. Qty.	Installation Tools
<b>PLST4HS25-TL300</b>	15.3 (389)	0.300 (7.6)	4.00 (102)	120 (534)	Heat Stabilized Weather Resistant Nylon 6.6	Black	Heat and UV Resistant	—	V2	—	250	GTH-E, GS4H-E, GS4EH-E, PTH, STH2, ST3EH



**Like what you see and want more?**

Visit [www.panduit.com](http://www.panduit.com) for the full offering of Panduit products

### Locking Tie Double Loop Cable Ties

- Weather resistant material has greater resistance to damage caused by ultraviolet light – indoor or outdoor use
- Heat stabilized material for high temperature applications up to 239°F (115°C) – indoor use
- A fast and economical method to secure and separate two bundles
- Reduces part number inventory – single part covers multiple bundle sizes
- Installs easily by hand – second loop can be installed with Panduit® cable tie installation tools
- Weather resistant temperature is 185°F (85°C)

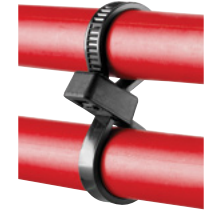
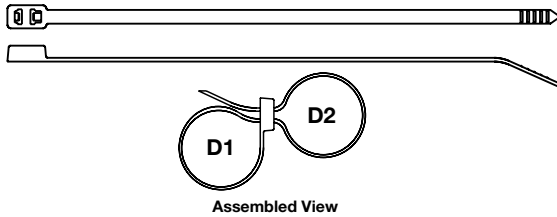

Part Number	Max. Combined Bundle Dia. D1+D2		Length		Width		Thickness		Min. Loop Tensile Str.		Recommended Installation Tool	Std. Pkg. Qty.	Std. Ctn. Qty.
	In.	mm	In.	mm	In.	mm	In.	mm	lbs.	N			

#### Weather Resistant Nylon 6.6 Standard Cross Section

PLB2S-C0	1.80	46	7.6	193	0.190	4.8	0.052	1.3	50	222	GTS-E, GS2B-E, GTH-E, GS4H-E, PTS, PTH, PPTS, STS2, STH2	100	1000
PLB4S-M0	4.10	104	14.8	376								1000	5000

#### Light-Heavy Cross Section

PLB4H-TL0	3.60	91	14.7	373	0.300	7.6	0.075	1.9	120	534	GTH-E, GS4H-E, GS4EH-E, PTH, STH2, ST3EH	250	2500
-----------	------	----	------	-----	-------	-----	-------	-----	-----	-----	--	-----	------

#### Heat Stabilized Nylon 6.6 Standard Cross Section

PLB2S-M30	1.80	46	7.6	193	0.190	4.8	0.052	1.3	50	222	GTS-E, GS2B-E, GTH-E, GS4H-E, PTS, PTH, PPTS, STS2, STH2	1000	10000
PLB3S-M30	3.00	76	11.8	300									

### Locking Tie Double Clamp Cable Ties

**Material:** Impact modified heat stabilized weather resistant Nylon 6.6.  
239°F (115°C)



Part Number	Max Bundle Diameter		Length		Width		Thickness		Min. Loop Tensile		Recommended Installation Tool	Std. Pkg. Qty.	Std. Ctn. Qty.
	In.	mm	In.	mm	In.	mm	In.	mm	lbs.	N			
PLDC1.5EH-C350	1.3	33	13.1	333	0.5	12.70	0.055	1.4	150	667	GTH-E, GS4EH-E, PPTHE	100	500
PLDC2.5EH-C350	2.3	58	19.2	489									

# CABLE TIE ACCESSORIES

---

ABMQ Multiple Bridge Adhesive Backed Cable Tie Mounts .....	66
Epoxy Applied Mounts.....	66
Cable Tie Mounts .....	67-68
High and Medium Torque Tie Mounts .....	68
Swivel Mounts .....	69
4-Way Tie Anchor Mounts – Screw Applied.....	69
Low Profile Mounts – Screw Applied.....	69
Multiple Tie Plates .....	70
Right Angle Mounts.....	71
Lightening Hole Mounts .....	71
Stud Tie Mounts .....	72
Metal Clip-On Mounts.....	72
Push Mounts.....	72-73
Pan-Post™ Standoffs.....	74
Right Angle Bases.....	74
Closed Connector Rings .....	75
Cable Spacers.....	75
Aerial Support Ties – Weather Resistant Polypropylene .....	76
Marker Plates – Loose Piece.....	76
Adhesive Backed Cable Tie Mounts.....	77-78
Adhesive Backed Cord Clips.....	79
“J” Clip .....	79
Metal Adhesive Backed Cord Clip.....	79
Latching Wire Clips .....	80
Bevel Entry Clips.....	80
Adhesive Backed Latching Clips.....	81
Latching Flat Cable Mounts.....	81
Flat Cable Clip.....	81
Metal Solar Edge Clips.....	82
Harness Clips.....	82
Quick-Build™ Harness Board System & Accessories .....	83-84



Product Showcase

Abrasion Protection

Cable Cleats

Cable Ties

Cable Tie Accessories

Cable Tie Tools

Identification Products

Power Connectors

Grounding Connectors

Safety Solutions

Stainless Steel Ties

Terminals

Wiring Duct

Part Number Index

### **ABMQ Multiple Bridge Adhesive Backed Cable Tie Mounts**

- Multiple cable tie bridges on one mount speeds installation of cable bundles by reducing the number of mounts applied
- Dovetail connection system provides alignment and a joining method to expand routing capabilities
- V-groove allows for easy separation into two mounts with two bridges each for separate applications
- 4-way cable tie bridges allow cable bundles to be secured perpendicular to the mount for even spacing or inline to secure a bundle in multiple places
- Large adhesive surface area provides long-term reliability and keeps product in place despite heavy load or high stress

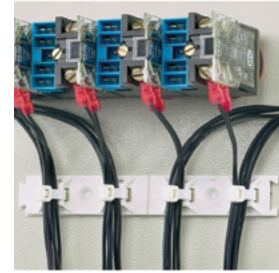

Part Number	Used with Cable Ties‡	Material	Color	Suitable Environment	Mounting Method	Std. Pkg. Qty.	Std. Ctn. Qty.
<a href="#">ABMQS-A-C</a>	M, I, S	ABS	White	Indoor	Rubber	100	1000

‡Cable tie cross section sizes: M = Miniature, I = Intermediate, and S = Standard

### **Epoxy Applied Mounts**

- Provide a fast, strong, economical method to secure wire/ cable to most surfaces
- Eliminate the need to drill holes
- Adhesive not included. Order [EMA-X](#). Each cup contains adhesive for three EMS mounts



Part Number	Used with Cable Ties‡	Material	Color	Suitable Environment	Mounting Method	Std. Pkg. Qty.	Std. Ctn. Qty.
<a href="#">EMS-A-C0</a>	M, I, S	Weather Resistant Nylon 6.6	Black	Outdoor	EMA epoxy	100	1000

‡Cable tie cross section sizes: M = Miniature, I = Intermediate, and S = Standard

### **Epoxy Applied Swivel Mounts**

- Swivels 360° to assure proper orientation with harness
- Four inspection holes to check adhesive coverage
- For indoor use only
- Adhesive not included. Order [EMA-X](#). Each cup contains adhesive for three ASMS mounts

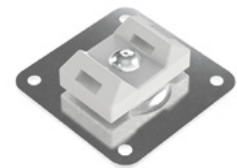

Part Number	Used with Cable Ties‡	Mounting Method	Std. Pkg. Qty.	Std. Ctn. Qty.
<a href="#">ASMS-A-X</a>	M, I, S, SGM, SGI	EMA epoxy	10	1000

‡Cable tie cross section sizes: M = Miniature, I = Intermediate, S = Standard, SGM = Super-Grip® Miniature, and SGI = Super-Grip® Intermediate"



### Cable Tie Mounts – Screw Applied

- UL 62275 Type 2, 21 per UL file E136577
- Unique cradle design provides maximum stability for the cable bundles
- Low profile design keeps bundle close to mounting surface

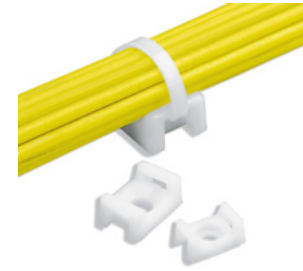
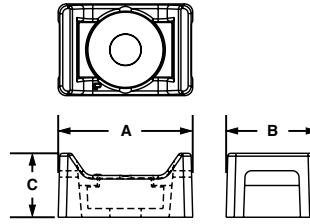

Part Number	Compatible Cross-Section Cable Ties†	Length (A) In. (mm)	Width (B) In. (mm)	Height (C) In. (mm)	Material	Color	Screw Size	Suitable Environment	Std. Pkg. Qty.				
TM1S6-C	M	.51 (13.0)	.32 (8.0)	.23 (5.8)	Nylon 6.6	Natural	#6 (M3)	Indoor	100				
TM2S6-C	M, I, S	.63 (16.0)	.43 (10.8)	.28 (7.0)						Weather Resistant Nylon 6.6	Black	#8 (M4)	Outdoor
TM2S8-C					Nylon 6.6	Natural	Indoor						
TM2S8-C0								Weather Resistant Nylon 6.6		Black	Outdoor		
TM3S8-C	M, I, S, LH	.86 (21.9)	.61 (15.5)	.37 (9.4)	Nylon 6.6	Natural	#10 (M5)	Indoor					
TM3S8-C0					Weather Resistant Nylon 6.6	Black		Outdoor					
TM3S10-C					Nylon 6.6	Natural	Indoor						
TM3S10-C0								Weather Resistant Nylon 6.6		Black	Outdoor		
TM3S10-M					Nylon 6.6	Natural	Indoor						
TM3S25-C								Weather Resistant Nylon 6.6		Black	1/4 (M6) screw	Outdoor	
TM3S25-C0					.88 (22.3)	.63 (16.0)	.38 (9.6)		Nylon 6.6				Natural
									Weather Resistant Nylon 6.6	Black		Outdoor	100

†Cable tie cross section sizes: M = Miniature, I = Intermediate, S = Standard, and LH = Light-Heavy



Like what you see and want more?

Visit [www.panduit.com](http://www.panduit.com) for the full offering of Panduit products



### Extra-Heavy Cable Tie Mounts – Screw Applied

- UL 62275 Type 2, 21 per UL file E136577
- Unique cradle design provides maximum stability for the cable bundles

- Route and support large diameter and heavy cable bundles
- Can also be used with Tak-Ty™ Hook & Loop ties

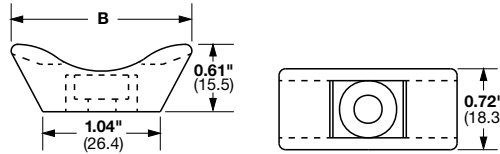

Part Number	Compatible Cross-Section Cable Ties†	Material	Color	Screw Size	B	Suitable Environment	Std. Pkg. Qty.		
<b>TMEH-S8-Q0</b>	M, I, S, HS, LH, H, EH, HLM	Weather Resistant Nylon 6.6	Black	#8 (M4)	1.62 (41.1)	Outdoor	25		
<b>TMEH-S10-C0</b>				#10 (M5)	1.65 (41.9)		100		
<b>TMEH-S10-Q0</b>		Weather Resistant Polypropylene					1/4 (M6)	1.62 (41.1)	25
<b>TMEH-S10-C100</b>				100					
<b>TMEH-S25-C0</b>		Weather Resistant Nylon 6.6							25
<b>TMEH-S25-Q0</b>									25

†Cable tie cross section sizes: M = Miniature, I = Intermediate, S = Standard, HS = Heavy-Standard, LH = Light-Heavy, H = Heavy, EH = Extra-Heavy, and HLM = Miniature Tak-Ty® Hook & Loop Ties

### High and Medium Torque Tie Mounts

- A retention tab within the mount bolt hole creates interference to hold the bolt in different positions without any external assistance.
- TMEH4 version includes a steel insert (as shown in image). TMEH3 version does not come with steel insert



Part Number	Used with Cable Ties*	Material	Torque (Ft.-lbs.)	Color	Suitable Environment	Mounting Method	Std. Pkg. Qty.	Std. Ctn. Qty.
<b>TMEH4S8-D350</b>	M, I, S, HS, LH, H, EH, WS	Impact Modified Heat Stabilized Weather Resistant Nylon 6.6 with Zinc Plated Steel Insert	114	Black	Indoor/Outdoor	5/16" (8mm) bolt	500	1000
<b>TMEH4S10-D350</b>						3/8" (10mm) bolt		
<b>TMEH3S8-D350</b>		Impact Modified Heat Stabilized Weather Resistant Nylon 6.6	5/16" (8mm) bolt					
<b>TMEH3S10-D350</b>			3/8" (10mm) bolt					

\*Cable tie cross section sizes: M = Miniature, I = Intermediate, S = Standard, HS = Heavy-Standard, LH = Light-Heavy, H = Heavy, EH = Extra Heavy, and WS = Wide Strap

### Swivel Mounts

- The two mounts are securely fastened together with a connecting rivet that allows both mounts to rotate
- Can join bundles of cable, tubing, or hoses that may need to move or are not parallel
- Separates bundles to avoid abrasion
- Material: Weather Resistant Nylon 6.6



Part Number	Used with Cable Ties‡	Pull Apart Force		Color	Suitable Environment	Std. Pkg. Qty.	Std. Ctn. Qty.
		lbs	g				
<b>TM3-X2-C0Y</b>	M, I, S, HS, LH	120	54,431	Black	Indoor/Outdoor	100	1000
<b>TMEH-X2-L0Y</b>	M, I, S, HS, LH, H, EH, HLM	250	113,398			50	500

‡Cable tie cross section sizes: M = Miniature, I = Intermediate, S = Standard, HS = Heavy-Standard, LH = Light-Heavy, H = Heavy, EH = Extra-Heavy, and HLM = Miniature Tak-Ty® Hook & Loop Ties

### UL LISTED 4-Way Tie Anchor Mounts – Screw Applied

- UL 62275 Type 2, 21 per UL file E136577
- 4-way cable tie entry makes part orientation fast and easy
- Small overall size allows use where space is limited

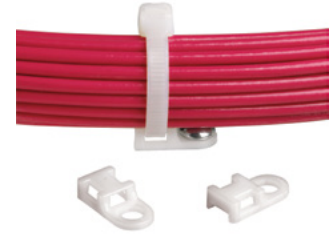
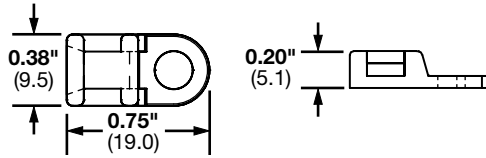

Part Number	Compatible Cross-Section Cable Ties‡	Material	Color	Screw Size	Suitable Environment	Std. Pkg. Qty.
<b>TA1S8-C</b>	M, I, S	Nylon 6.6	Natural	#8 (M4)	Indoor	100
<b>TA1S8-M</b>			Black		Outdoor	1000
<b>TA1S8-M0</b>		Weather Resistant Nylon 6.6				

‡Cable tie cross section sizes: M = Miniature, I = Intermediate, and S = Standard

### Super-Grip® Cable Tie Anchor Mounts

- 4-way cable tie entry
- low profile and versatile screw-installed mount
- For indoor use only
- Super-Grip™ Mounts are Designed to withstand rough installation practices that occur in MRO and Construction Projects

Part Number	Compatible Cross-Section Cable Ties‡	Material	Color	Screw Size	Suitable Environment	Std. Pkg. Qty.
<b>SGTA1S8-C*</b>	SGM, SGI, SGS	Nylon 6.6	Natural	#8 (M4)	Indoor	100

‡Cable tie cross section sizes: SGM = Super-Grip® Miniature, SGI = Super-Grip® Intermediate, and SGS = Super-Grip® Standard  
\*Not UL Listed

### UL LISTED Low Profile Mounts – Screw Applied

- Low profile design keeps bundle close to mounting surface
- Install with a screw or rivet for a strong, secure installation
- Small overall size
- For indoor use only
- Material: Nylon 6.6



Part Number	Used with Cable Ties‡	Color	Mounting Method	Std. Pkg. Qty.	Std. Ctn. Qty.
<b>LPMS-S8-C</b>	M, I, S	Natural	#8 (M4) Countersunk Screw	100	1000

‡Cable tie cross section sizes: M = Miniature, I = Intermediate, and S = Standard

### Contour Multiple Tie Plates

- Designed for aerospace industry to minimize chance for abrasion
- Low profile design keeps bundle close to mounting surface
- For indoor use only
- Heat stabilized Nylon 6.6 material

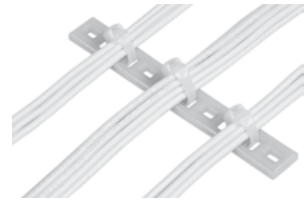
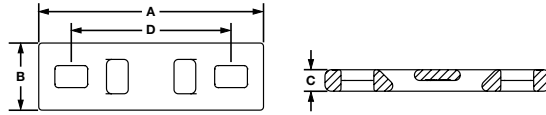

Part Number	No. of Bundles	Used with Cable Ties‡	Length (A)		Width (B)		Height (C)		Hole Spacing (D)		Mounting Method	Std. Pkg. Qty.	Std. Ctn. Qty.
			In.	mm	In.	mm	In.	mm	In.	mm			
<b>MTPC3H-E10-C39</b>	3	M, I, S, HS, LH, H	5.09	129.3	0.63	16.0	0.20	5.2	4.50	114.3	#10 (M5) Screw	100	1000

‡Cable tie cross section sizes: M = Miniature, I = Intermediate, S = Standard, HS = Heavy-Standard, LH = Light-Heavy, and H = Heavy

### Multiple Tie Plates

- Used to secure closely spaced wire bundles
- Low profile design keeps bundle close to mounting surface
- For indoor use only
- Material: Nylon 6.6

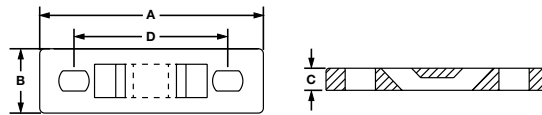

Part Number	No. of Bundles	Used with Cable Ties‡	Length (A)		Width (B)		Height (C)		Hole Spacing (D)		Mounting Method	Mil. Std. Part Number	Std. Pkg. Qty.	Std. Ctn. Qty.
			In.	mm	In.	mm	In.	mm	In.	mm				
<b>MTP2S-E6-C</b>	2	M, I, S	3.00	76.2	0.50	12.7	0.13	3.2	2.50	63.5	#6 (M3) Screw	MS3339-2-9	100	1000
<b>MTP3S-E6-C</b>	3	M, I, S	4.25	108.0					3.75	95.3		MS3339-3-9		
<b>MTP3H-E6-C</b>		M, I, S, HS, LH, H	5.09	129.3	0.63	16.0	0.20	5.2	4.50	114.3		MS3339-8-9		
<b>MTP4S-E6-C</b>		4	M, I, S	5.50	139.7	0.50	12.7	0.13	3.2	5.00		127.0		
<b>MTP5H-E6-C</b>	5	M, I, S, HS, LH, H	8.09	205.5	0.63	16.0	0.20	5.2	7.50	190.5		MS3339-10-9		
<b>MTP6H-E10-C</b>	6	M, I, S, HS, LH, H	9.59	243.6					9.00	228.6		#10 (M5) Screw		

‡Cable tie cross section sizes: M = Miniature, I = Intermediate, S = Standard, HS = Heavy-Standard, LH = Light-Heavy, and H = Heavy





### Right Angle Mounts

- Hold cable bundles away from the sharp edges of bulkheads or cabinet holes
- Can also be used to mount cable bundles adjacent to any surface
- For indoor use only
- Material: Nylon 6.6

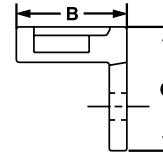
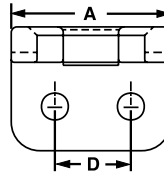

Part Number	Used with Cable Ties‡	Length (A)		Width (B)		Height (C)		Hole Spacing (D)		Color	Mil. Std. Part Number	Mounting Method	Std. Pkg. Qty.	Std. Ctn. Qty.
		In.	mm	In.	mm	In.	mm	In.	mm					
<b>RAMS-S3-M</b>	M, I, S	0.56	14.2	0.39	9.9	0.44	11.0	0.28	7.1	Natural	MS3341-2-9	#3 (M2.5) Screw or 3/32 (2.4) Rivet	1000	5000
<b>RAMH-S6-D</b>	M, I, S, HS, LH, H	1.00	25.4	0.75	19.1	1.00	25.4	0.50	12.70		MS3341-1-9	#6 (M3) Screw or 1/8 (3.2) Rivet	500	

‡Cable tie cross section sizes: M = Miniature, I = Intermediate, S = Standard, HS = Heavy-Standard, LH = Light-Heavy, and H = Heavy



### Lightening Hole Mounts

- Secure cable bundles that run through bulkhead lightening holes
- Protect cable bundles from sharp edges
- For indoor use only
- Material: Nylon 6.6

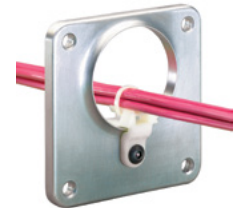
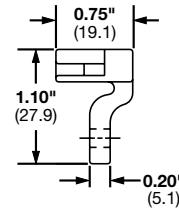
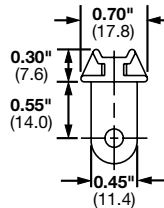

Part Number	Used with Cable Ties‡	Color	Mil. Std. Part Number	Mounting Method	Std. Pkg. Qty.	Std. Ctn. Qty.
<b>LHMS-S6-D</b>	M, I, S	Natural	MS3340-1-9	#6 (M3) Screw or 9/64 (3.5) Rivet	500	2500
<b>LHMS-S10-D</b>			—	#10 (M5) Screw or 3/16 (4.7) Rivet		

‡Cable tie cross section sizes: M = Miniature, I = Intermediate, and S = Standard



**Like what you see and want more?**

Visit [www.panduit.com](http://www.panduit.com) for the full offering of Panduit products

### Stud Tie Mounts

- Easily applied to bolts or studs with a light hammer blow or turning of the mount
- Designed for use with cable ties to route and secure cable bundles, air, water and hydraulic lines
- Material: Impact Modified Weather Resistant Nylon 6.6

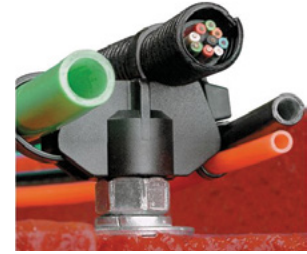

Part Number	Used with Cable Ties‡	Color	Environment	Mounting Method	Std. Pkg. Qty.
<b>TMSTHS11-DO</b>	M, I, S, HS, LH, H	Black	Outdoors	7/16" stud dia. (11mm)	500
<b>TMSTHS16-DO</b>				5/8" stud dia. (16mm)	

‡Cable tie cross section sizes: M = Miniature, I = Intermediate, S = Standard, HS = Heavy-Standard, LH = Light-Heavy, and H = Heavy

### Metal Clip-On Mounts

- Clips on sheet metal edges for fast mounting of harness with cable ties
- Allows cable tie entry from all four sides for easy harness orientation
- For indoor use only
- Material: Zinc plated steel



Part Number	Used with Cable Ties‡	Height (A)		Max. Panel Thickness		Mounting Method	Std. Pkg. Qty.	Std. Ctn. Qty.
		In.	mm	In.	mm			
<b>MCMS12-P-C</b>	M, I, S	0.31	8.0	0.13	3.2	Clip-On	100	500
<b>MCMS25-P-C</b>		0.46	11.5	0.24	6.1			
<b>MCMS30-P-C</b>		0.55	14.0	0.27	6.9			

‡Cable tie cross section sizes: M = Miniature, I = Intermediate, and S = Standard

### UL® US Push Barb Cable Tie Mounts

- UL 62275 Type 1, 11 per UL file E136577
- Wing provides added stability
- Requires no adhesive or additional mounting hardware
- Can be use where only one side of the panel is accessible

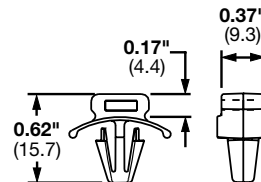

Part Number	Compatible Cross-Section Cable Ties‡	Max Panel Thickness In. (mm)	Panel Hole Diameter In. (mm)	Material	Color	Suitable Environment	Std. Pkg. Qty.
<b>PWMS-H25-C</b>	M, I, S	.11 (2.7)	.25 (6.5)	Nylon 6.6	Natural	Indoor	100
<b>PWMS-H25-M</b>				Weather Resistant Nylon 6.6	Black	Outdoor	1000
<b>PWMS-H25-M0</b>							

‡Cable tie cross section sizes: M = Miniature, I = Intermediate, and S = Standard



### Push Mounts

- Require no adhesive or additional mounting hardware
- Can be used where only one side of the panel is accessible

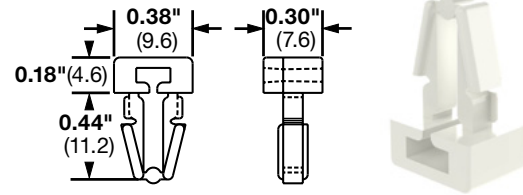

Part Number	Used with Cable Ties‡	Max. Panel Thickness		Panel Hole Diameter		Material	Color	Environment	Mounting Method	Std. Pkg. Qty.	Std. Ctn. Qty.
		In.	mm	In.	mm						
<b>PM2H25-C</b>	M, I, S	0.125	3.2	0.250	6.4	Nylon 6.6	Natural	Indoors	Push Barb	100	500

‡Cable tie cross section sizes: M = Miniature, I = Intermediate, and S = Standard

### Push Button Mounts

- UL 62275 Tpe 2,21 per UL file
- Requires no adhesive or additional mounting hardware
- Designed for use where both sides of the panel are accessible

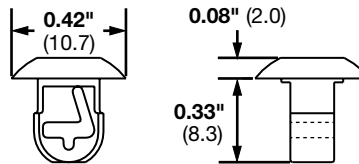

Part Number	Compatible Cross-Section Cable Ties‡	Max Panel Thickness In. (mm)	Panel Hole Diameter In. (mm)	Material	Color	Suitable Environment	Pkg. Qty.
<b>PBMS-H25-C</b>	M, I, S	.13 (3.2)	.25 (6.4)	Nylon 6.6	Natural	Indoor	100
<b>PBMS-H25-M</b>				Weather Resistant Nylon 6.6	Black	Outdoor	1000
<b>PBMS-H25-M0</b>						Indoor	
<b>PBMS-H25-M30</b>				Heat Stabilized Nylon 6.6	Indoor		

‡Cable tie cross section sizes: M = Miniature, I = Intermediate, and S = Standard

### Fir Tree Push Mounts

- Unique alternating barb design
- Lock securely into position
- Umbrella tensioning
- Exclusive contoured anvil head



Part Number	Used with Cable Ties‡	Head Diameter		Panel to Top of Mount		Overall Height		Panel Hole Diameter Range		Panel Thickness Range		Material	Std. Pkg. Qty.	Std. Ctn. Qty.
		In.	mm	In.	mm	In.	mm	In.	mm	In.	mm			
<b>PUM-049-M30</b>	M, I, S	0.65	16.5	0.26	6.6	0.54	13.8	0.18 – 0.19	4.6 – 4.9	0.03 – 0.12	0.7 – 3.0	Heat Stabilized Nylon 6.6	1000	5000
<b>PUM-071-M30</b>						0.67	16.9	0.25 – 0.28	6.3 – 7.1	0.03 – 0.28	0.8 – 7.0			

‡Cable tie cross section sizes: M = Miniature, I = Intermediate, and S = Standard



### Pan-Post™ Standoffs

- Supports cable bundles above or away from surface
- For indoor use only
- Material: Nylon 6.6



Part Number	Used with Cable Ties‡	Height (A)		Color	Mounting Method	Std. Pkg. Qty.	Std. Ctn. Qty.
		In.	mm				
PP2S-S10-X	M, I, S	4.60	116.8	Natural	#10 (M5) Screw	10	100
PP2S-S12-X					#12 (M5.5) Screw		

‡Cable tie cross section sizes: M = Miniature, I = Intermediate, and S = Standard

### Flat Pan-Post™ Standoffs

- Standard EIA hole spacing allows product to be mounted with user supplied screws up to 1/4" diameter
- Organize cables in standard cabinets and racks
- Mounting method: 1/4" (M6) screw
- Use where space is limited
- For indoor use only

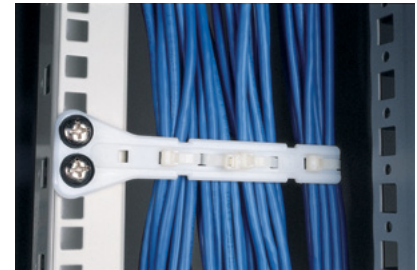

Part Number	Used with Cable Ties‡	Material	Color	Mounting Method	Std. Pkg. Qty.	Std. Ctn. Qty.
PPF2S-S25-V69	M, I, S	Flame Retardant Nylon 6.6	Natural	Two 1/4" (M6) screws	5	100

‡Cable Tie Cross Section Sizes: M = Miniature, I = Intermediate, and S = Standard



### Right Angle Bases

- Support cable above the mounting surface

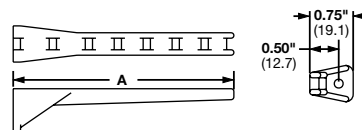

Part Number	Used with Cable Ties‡	Max. Flat Cable Width		Length (A)		Material	Color	Environment	Mounting Method	Std. Pkg. Qty.	Std. Ctn. Qty.
		In.	mm	In.	mm						
RAFCB11-S6-C20	M, I, S	1.00	25.4	1.75	44.4	Nylon 6.6	Black	Indoors	#6 (M3) Screw	100	1000
RAFCB12-S6-C20		2.00	50.8	2.78	70.6						

‡Cable Tie Cross Section Sizes: M = Miniature, I = Intermediate, and S = Standard



### Closed Connector Rings



- Connect multiple cable bundles

Part Number	Used with Cable Ties‡	Length (A)		Width (B)		Height (C)		Material	Color	Environment	Mounting Method	Std. Pkg. Qty.	Std. Ctn. Qty.	
		In.	mm	In.	mm	In.	mm							
<b>CR2-M</b>	M, I, S	0.33	8.4	0.24	6.1	0.20	5.0	Nylon 6.6	Natural	Indoors	Cable Ties	1000	10000	
<b>CR4H-M</b>	M, I, S, HS, LH	0.57	14.5	0.36	9.1	0.30	7.6		Weather Resistant Nylon 6.6	Black				Indoors/Outdoors
<b>CR4H-M0</b>														

‡Cable tie cross section sizes: M = Miniature, I = Intermediate, S = Standard, HS = Heavy-Standard, and LH = Light-Heavy

### Cable Spacers

- Used to separate and/or hang cords, cables, and tubing



Part Number	Used with Cable Ties‡	Material	Color	Environment	Mounting Method	Std. Pkg. Qty.	Std. Ctn. Qty.
<b>CSH-D20</b>	S, H	Nylon 6.6	Black	Indoors	Cable Ties	500	2500
<b>CSH-D0</b>		Weather Resistant Nylon 6.6		Indoors/Outdoors			

‡Cable tie cross section sizes: S = Standard, and H = Heavy

### Cable Spacer Cross

- Connects two bundles at 90°
- Separates bundles to prevent abrasion
- Dual cradle design stabilizes cable bundle

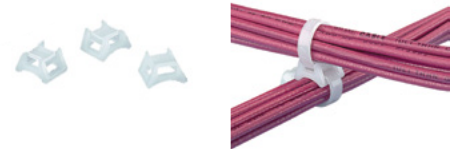

Part Number	Used with Cable Ties‡	Material	Color	Environment	Mounting Method	Std. Pkg. Qty.	Std. Ctn. Qty.
<b>CSCS-M</b>	M, I, S	Nylon 6.6	Natural	Indoors	Cable Ties	1000	10000

‡Cable tie cross section sizes: M = Miniature, I = Intermediate, and S = Standard

### Stackable Aerial Cable Spacers

- Greater resistance to damage caused by ultraviolet light – indoor or outdoor use
- Each spacer snaps into another to increase spacer heights by 1/2" increments
- Designed for use in parallel or perpendicular applications
- For use with Dura-Ty™ Cable Ties shown on 49



Part Number	Used with Cable Ties‡	Material	Color	Environment	Mounting Method	Std. Pkg. Qty.	Std. Ctn. Qty.
<b>SACS50-T100</b>	LH, H, EH	Weather Resistant Polypropylene	Black	Outdoors	Cable Ties	200	2000

‡Cable tie cross section sizes: LH = Light-Heavy, H = Heavy, and EH = Extra-Heavy

### Aerial Support Ties – Weather Resistant Polypropylene

- Designed to attach coax or telephone cable to the 1/4" (6.4mm) or 5/16" (7.9mm) support strand to form the expansion loop and keep equipment and cables clear of pole hardware
- One-piece construction with integral 1/2" (12.7mm) spacer reduces inventory costs of separate spacer and bands, and installs faster to lower installed cost
- Releasable and re-usable
- Hand install only



Part Number	Length (A)		Max Bundle Diameter		Min Loop Tensile Strength		Std. Pkg. Qty.	Std. Ctn. Qty.
	In.	mm	In.	mm	LB	N		
AST20-5-C100	8.4	214	2.00	51	75	334	100	1000
AST25-5-C100	10.0	254	2.50	64				

### Marker Plates – Loose Piece

- Install as flags, tags, or wrap-around identification plates to clearly identify all wire harnesses
- Use with nylon marking pens for an easy and economic alternative to identify wire harnesses
- Available in black or white to match the wire harness
- Thickness: 0.02 inches (0.5mm)



Part Number	Used with Cable Ties‡	Length (A)		Width (B)		Hole Spacing (C)		Material	Color	Environment	Mounting Method	Std. Pkg. Qty.	Std. Ctn. Qty.
		In.	mm	In.	mm	In.	mm						
MP250-C	M, I, S	2.50	63.5	0.75	19.0	2.03	51.6	Nylon 6.6	White	Indoors	Cable Ties	100	500
MP350-C		3.50	88.9			3.03	77.7						1000
MP250W175-C		2.50	63.5	1.75	44.5	2.03	51.6						

‡Cable tie cross section sizes: M = Miniature, I = Intermediate, and S = Standard



**Like what you see and want more?**

Visit [www.panduit.com](http://www.panduit.com) for the full offering of Panduit products



### UL® 4-Way Adhesive Backed Cable Tie Mounts

- UL 62275 Type 1, 11 per UL file E136577
- Produced 2-up or 4-up for fast and easy liner removal for speed of installation
- Flammability Rating: -Nylon 6.6 V-2, ABS HB

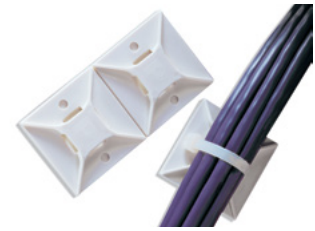

Part Number	L x W In. (mm)	Compatible Cross-Section Cable Ties‡	Material	Color	Adhesive Base	Suitable Environment	Static Load Capacity lbs. (g)	Std. Pkg. Qty.
<b>BEST SELLER</b> ABM1M-A-M	0.50 x 0.50 (12.7 x 12.7)	M	Nylon 6.6	White	Rubber	Indoor	.13 (59)	1000
ABM1M-AT-MO			Weather Resistant Nylon 6.6	Black	Acrylic	Outdoor		
<b>BEST SELLER</b> ABMM-A-C	0.75 x 0.75 (19.1 x 19.1)	M, I	ABS	White	Rubber	Indoor	.30 (136)	100
ABMM-AT-CO			Weather Resistant ABS	Black	Acrylic	Outdoor		
<b>BEST SELLER</b> ABMM-A-D			ABS	White	Rubber	Indoor	500	
ABMM-AT-DO			Weather Resistant ABS	Black	Acrylic	Outdoor		
<b>BEST SELLER</b> ABM2S-A-C	1.00 x 1.00 (25.4 x 25.4)	M, I, S	ABS	White	Rubber	Indoor	.50 (227)	100
ABM2S-AT-CO			Weather Resistant ABS	Black	Acrylic	Outdoor		
<b>BEST SELLER</b> ABM2S-A-D			ABS	White	Rubber	Indoor	500	
ABM2S-AT-DO			Weather Resistant ABS	Black	Acrylic	Outdoor		
<b>BEST SELLER</b> ABM100-A-C			Nylon 6.6	White	Rubber	Indoor	.63 (286)	100
ABM100-AT-CO			Weather Resistant Nylon 6.6	Black	Acrylic	Outdoor		
<b>BEST SELLER</b> ABM112-A-C	1.12 x 1.12 (28.6 x 28.6)		Nylon 6.6	White	Rubber	Indoor	.63 (286)	
ABM112-AT-CO			Weather Resistant Nylon 6.6	Black	Acrylic	Outdoor		
ABM3H-A-L	1.50 x 1.50 (38.1 x 38.1)	M, I, S, LH, H	Nylon 6.6	White	Rubber	Indoor	1.13 (513)	50
ABM3H-AT-LO			Weather Resistant Nylon 6.6	Black	Acrylic	Outdoor		
ABM4H-A-L	2.00 x 2.00 (50.8 x 50.8)		Nylon 6.6	White	Rubber	Indoor	2.0 (907)	200
ABM4H-AT-TO			Weather Resistant Nylon 6.6	Black	Acrylic	Outdoor		

‡Cable tie cross section sizes: M = Miniature, I = Intermediate, S = Standard, LH = Light Heavy, and H = Heavy



**Like what you see and want more?**

Visit [www.panduit.com](http://www.panduit.com) for the full offering of Panduit products

### Super-Grip™ Adhesive Backed Cable Tie Mounts

- For use with Super-Grip Cable Ties
- Low profile design keeps bundle close to mounting surface
- Small overall size allows use where space is limited
- Produced 2-up for fast and easy liner removal for speed of installation

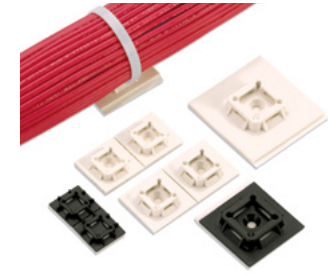

Part Number	L x W In. (mm)	Compatible Cross-Section Cable Ties‡	Material	Color	Adhesive Base	Suitable Environment	Static Load Capacity lbs. (g)	Std. Pkg. Qty.
<b>SGABM20-A-C</b>	0.75 x 0.75 (19.1 x 19.1)	SGM, SGI	Nylon 6.6	White	Rubber	Indoor	.28 (127)	100
<b>SGABM20-AT-C0</b>			Weather Resistant Nylon 6.6	Black	Acrylic	Outdoor	.56 (254)	
<b>SGABM20-AV-C300</b>			Heat Stabilized Weather Resistant Nylon 6.6		High Bond Acrylic			
<b>SGABM25-A-C</b>	1.00 x 1.00 (25.4 x 25.4)	SGM, SGI, SGS	Nylon 6.6	White	Rubber	Indoor	.5 (227)	
<b>SGABM25-AT-C0</b>			Weather Resistant Nylon 6.6	Black	Acrylic Adhesive	Outdoor	1.0 (453)	
<b>SGABM25-AV-C300</b>			Heat Stabilized Weather Resistant Nylon 6.6		High Bond Acrylic			
<b>SGABM30-AV-C300</b>	1.12 x 1.12 (28.6 x 28.6)						1.2 (567)	

‡Cable tie cross section sizes: SGM = Super-Grip Miniature, SGI = Super-Grip Intermediate, and SGS = Super-Grip Standard



**Like what you see and want more?**

Visit [www.panduit.com](http://www.panduit.com) for the full offering of Panduit products

### cUL<sup>us</sup> Adhesive Backed Cord Clips

- UL 1565 per UL file E136577
- Continuous use temperature for rubber adhesive is -20°F (-29°C) to 120°F (49°C)
- Cables are easily snapped into or out of the clips



Part Number	L x W In. (mm)	Maximum Cable Diameter In. (mm)	Material	Color	Adhesive Base	Suitable Environment	Static Load Capacity lbs. (g)	Std. Pkg. Qty.
ACC19-A-C	0.76 x 0.63 (19.3 x 16.0)	.19 (4.8)	Nylon 6.6	Natural	Rubber	Indoor	0.2 (91)	100
ACC19-AT-M0			Weather Resistant Nylon 6.6	Black	Acrylic	Outdoor		1000
ACC38-A-C	1.00 x 1.00 (25.4 x 25.4)	.38 (9.6)	Nylon 6.6	Natural	Rubber	Indoor	.50 (227)	100
<b>BEST SELLER</b> ACC38-A-M			Heat Stabilized Weather Resistant Nylon 6.6	Black	High Bond Acrylic	Outdoor		1.0 (454)
ACC38-AV-M300*								
ACC62-A-C	1.12 x 1.24 (28.5 x 31.4)	.62 (15.7)	Nylon 6.6	Natural	Rubber	Indoor	.69 (315)	100
<b>BEST SELLER</b> ACC62-A-D			Heat Stabilized Weather Resistant Nylon 6.6	Black	High Bond Acrylic	Outdoor		1.38 (630)
ACC62-AV-D300								

\*Not UL recognized

### cUL<sup>us</sup> "J" Clip

- Low profile clips retain cords, cables, or tubing
- Flexible design allows for easy cord insertion, yet holds bundle tightly
- For indoor use only
- Material: PVC

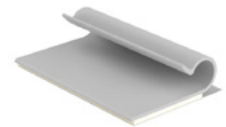

Part Number	Max Bundle Diameter		Length A		Width B		Height C		Diameter		Color	Adhesive Type	Std. Pkg. Qty.
	In.	mm	In.	mm	In.	mm	In.	mm	In.	mm			
AJC25-A-C	0.25	6.4	1.50	38.1	0.97	24.6	0.31	7.9	0.23	5.8	Light Gray	Rubber Adhesive Tape	100

### Metal Adhesive Backed Cord Clips

- Can be opened and closed without damaging clip in order to remove or add cables quickly and easily
- For indoor use only



Part Number	Max Bundle Diameter		Length A		Width B		Clip Width C		Material	Adhesive Type	Std. Pkg. Qty.
	In.	mm	In.	mm	In.	mm	In.	mm			
MACC25-A-C	0.25	6.4	0.77	19.6	0.54	13.7	0.29	7.4	Zinc Plated Steel	Rubber Adhesive	100
MACC25-A-D											500
MACC62-A-D	0.62	15.7	1.18	30.0	0.78	19.7					

### Latching Wire Clips

- Route and secure cords and cables
- Convenient releasable latch
- Available in six sizes with releasable latch

- Push barb parts are for use with a max panel thickness of 0.11" (2.7mm) and a hole diameter of 0.22" (5.6mm)
- For indoor use only
- Material: Nylon 6.6

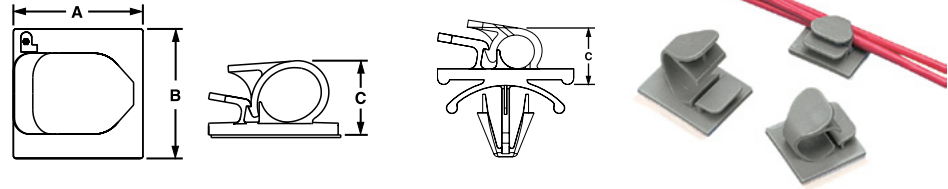

#### Adhesive Backed

Part Number	Max Bundle Diameter		A		B		C		Color	Mounting Method	Std. Pkg. Qty.
	In.	mm	In.	mm	In.	mm	In.	mm			
LWC25-A-C	0.25	6.4	0.88	22.2	1.00	25.4	0.45	11.4	Natural	Rubber Adhesive	100
LWC25-A-C14							0.56	14.2	Gray		
LWC38-A-C14			1.00	25.4			0.67	17.0	Black		
LWC38-A-C20	0.38	9.5						Natural	50		
LWC50-A-L					1.26	32.0	0.67	17.0			
LWC50-A-L20	0.50	12.7									

#### Push Mount

Part Number	Max. Bundle Diameter		Length		Width		Height		Color	Mounting Method	Std. Pkg. Qty.
	In.	mm	In.	mm	In.	mm	In.	mm			
LWC75-H25-L14	0.75	19.1	1.45	36.8	0.87	22.1	0.97	24.7	Gray	Push Barb	50

### Bevel Entry Clips

- Beveled entry allows for easy insertion of cable bundle

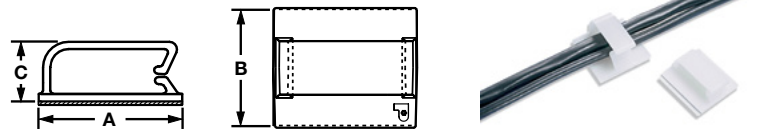

#### Adhesive Backed

Part Number	Max Bundle Diameter		Length (A)		Width (B)		Height (C)		Material	Color	Environment	Mounting Method	Std. Pkg. Qty.
	In.	mm	In.	mm	In.	mm	In.	mm					
BEC38-A-L	0.38	9.6	1.46	37.1	1.24	31.5	0.52	13.2	Nylon 6.6	Natural	Indoor	Rubber Adhesive	50
BEC62-A-T	0.62	15.7			0.79	20.1	200						
BEC75-A-T	0.75	19.0			1.49	37.8	0.89	22.6					

### c<sup>®</sup> **Adhesive Backed Latching Clips**

- Latching cover withstands vibration
- For indoor use only

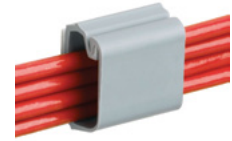

Part Number	Max. Bundle Diameter		Length (A)		Width (B)		Height (C)		Material	Color	Adhesive Type	Std. Pkg. Qty.
	In.	mm	In.	mm	In.	mm	In.	mm				
<b>LC3-A-C8</b>	0.20	5.0	0.75	19.1	0.78	19.8	0.47	11.9	PVC	Light Gray	Rubber	100
<b>LC5-A-C8</b>	0.36	9.1	1.00	25.4	1.01	25.7	0.61	15.5				
<b>LC10-A-L8</b>	0.93	23.6	1.51	38.4	1.51	38.4	0.84	21.3				50

### c<sup>®</sup> **Latching Flat Cable Mounts**

- Available in four sizes with a stack height of 0.17 inches (4.3mm) to accommodate different flat cable widths
- Low profile design holds wires, cables, and tubing
- Convenient releasable latch
- Large mounting base for high bonding strength
- For indoor use only
- Material: Nylon 6.6

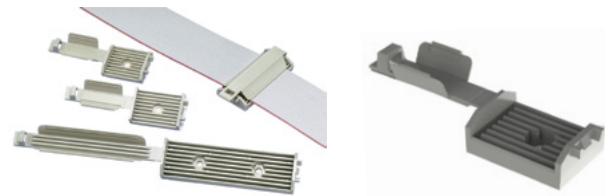

#### Adhesive Backed

Part Number	Cable Width		Length A		Width B		Hole Spacing C		Color	Mounting Method	Std. Pkg. Qty.
	In.	mm	In.	mm	In.	mm	In.	mm			
<b>FCM1-A-C14</b>	1.05	26.7	2.90	73.7	1.05	26.7	—	—	Gray	Rubber Adhesive	100
<b>FCM1.2-A-C14</b>	1.20	30.5	3.16	80.3	1.37	34.8	—	—			
<b>FCM2-A-C14</b>	2.05	52.1	5.06	128.5	2.22	56.4	1.53	38.9			

#### Screw Mounted

Part Number	Max. Bundle Diameter		Length		Width		Height		Color	Mounting Method	Std. Pkg. Qty.
	In.	mm	In.	mm	In.	mm	In.	mm			
<b>FCM1.2-S6-C14</b>	1.20	30.5	3.16	80.3	1.00	25.4	—	—	Gray	#6 (M3) Screw	100

### c<sup>®</sup> **Flat Cable Clip**

- Use with any width flat cable for a maximum stack height of 0.17 inches (4.3mm)
- Low profile design holds wires, cables, and tubing
- For indoor use only
- Material: PVC

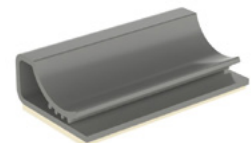

Part Number	Cable Width	Length A		Width B		Height C		Color	Mounting Method	Std. Pkg. Qty.
		In.	mm	In.	mm	In.	mm			
<b>FCC-A-C8</b>	Any Width Flat Cable	1.00	25.4	1.09	27.7	0.38	9.7	Gray	Rubber	100

### Metal Solar Edge Clips

- These clips are easy to install and provide installation efficiency in the field, no tools required
- Made of Stainless Steel, these clips offer a robust solution that can withstand the UV environment
- Good solution for managing PV wires in Solar Arrays; they clip and hold on Solar Frames



MEC100-2PV-C



MEC125-4PV-C

#### Metal Edge Clips that are oriented to route wires Parallel to outer edge of the Panel

Part Number	Panel Thickness	Recommended for use with 1000 V Solar Wires	Certification to cULus (UL 1565)	Std. Pkg. Qty.
<b>MEC100-2PV-C</b>	.051" – .098" (1.3 – 2.5 mm)	1 to 2 PV Wires 10 Gauge (6mm <sup>2</sup> )	Yes	100
<b>MEC125-4PV-C</b>	.051" – .125" (1.3 – 3.2mm)	1 to 4 PV Wires, 12 – 10 Gauge (4 – 6mm <sup>2</sup> )	No	



MEC100-90-PV-C



MEC100-90-2PV-C

#### Metal Edge Clips that are oriented to route wires Perpendicular to outer edge of the Panel

Part Number	Panel Thickness	Recommended for use with 1000 V Solar Wires	Certification to cULus (UL 1565)	Std. Pkg. Qty.
<b>MEC100-90-PV-C</b>	.051" – .098" (1.3 – 2.5mm)	1 to 2 PV Wires 12 Gauge (4mm <sup>2</sup> ), or USE-2 Wires	Yes	100
<b>MEC100-90-2PV-C</b>		1 to 2 PV Wires 10 Gauge (6mm <sup>2</sup> )		

### Harness Clips

- Integral “spring” holds wire bundles tightly
- Available in vertical and horizontal loading configurations
- Design of wing provides added stability



Part Number	Max. Bundle Diameter Range		Max. Panel Thickness		Panel Hole Diameter		Material	Color	Mounting Method	Std. Pkg. Qty.
	In.	mm	In.	mm	In.	mm				
<b>HCMP06B12-M20</b>	0.24 – 0.47	6 – 12	0.118	3.0	0.28	7.2	Nylon 6.6	Black	Push Mount	100



### Quick-Build™ Harness Board System

#### A Revolutionary Modular Solution for Harness Manufacturers

The modular, reusable solution consists of 1' X 1' (305mm x 305mm) grid tiles and specially designed, repositionable accessories that improve the productivity of wire harness assembly builds by up to 18%. The Quick-Build Accessories are more effective than nail, magnetic, or snap-in routing fixture methods. Accessories easily twist and lock in place until you're ready to make a change for faster routing of wires and design flexibility.

Low-Volume-High-Mix (LVHM) manufacturers achieve the greatest savings due to reduced material costs — up to 65% of layout and board builds. By reducing the number of bulky plywood boards, the Quick-Build Harness Board System delivers more than 50% in storage space savings. Whether you need to build a variety of wire and cable assemblies to meet different customer specifications or for prototyping new harness designs, the more you build, the greater your profitability.

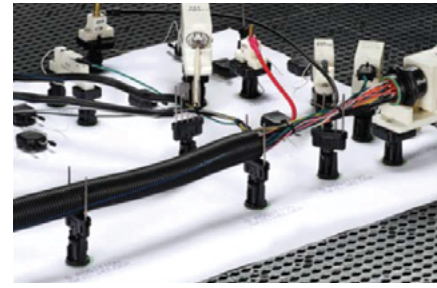

### Quick-Build™ Starter Kit

- Kit of Quick-Build components and various harness board accessories allows customers to evaluate the Quick-Build solution by simply ordering a single part number

Part Number	Description	Std. Pkg. Qty.
<b>QB-KIT2</b>	Starter Kit assortment that includes our core Quick-Build Components essential for faster wire harness builds. Black	1



### Quick-Build™ Grid Tile

- Install on top of plywood backing to provide mounting surface
- Secure to plywood with user supplied screws



Part Number	Description	Std. Pkg. Qty.
<b>QB-TILE</b>	1' X 1' (305mm x 305mm) square base component that allows Quick-Build™ mounting pegs and platforms to create a modular harness system. One package includes 8 tiles. Black	1

### Quick-Build™ Mounting Peg

- Repositionable to allow user to build different harness configurations as needed
- Pointed end inserts through drawing secured to grid tiles, providing the ability to create a harness on top of a drawing



Part Number	Description	Std. Pkg. Qty.
<b>QB-MOUNT-L</b>	Peg can be positioned and relocated. Accepts single nail holders, five nail holders, and Quick-Build mounting platforms. Allows accessories to rotate as needed even after mounting peg is installed into grid tile. Black	50

Note: Required for use with Quick-Build mounting platform and Quick-Build nail holders to provide a modular harness board system

Product Showcase

Abrasion Protection

Cable Cleats

Cable Ties

Cable Tie Accessories

Cable Tie Tools

Identification Products

Power Connectors

Grounding Connectors

Safety Solutions

Stainless Steel Ties

Terminals

Wiring Duct

Part Number Index

Product Showcase

Abrasion Protection

Cable Cleats

Cable Ties

Cable Tie Accessories

Cable Tie Tools

Identification Products

Power Connectors

Grounding Connectors

Safety Solutions

Stainless Steel Ties

Terminals

Wiring Duct

Part Number Index

### Traditional Harness Board Accessories

Harness board accessories have been around for a long time and continue to provide easy routing and forming of wires in harness fabrication.

#### Harness Board Nail

- Manufactured from Nickel Plated Steel
- Smooth finish on nails prevents abrasion to wire jackets



Part Number	Description	Compatible QB Components	Std. Pkg. Qty.
HBN2-T	Harness Board Nail – 2" long (2.66" overall)	QB-SN2-Q and QB-FN2-Q	200

#### Elastic Retainers – Replaceable Version

- Cable bundles are formed as individual wires are inserted
- Completed bundles can be easily removed
- The elastic band is replaceable

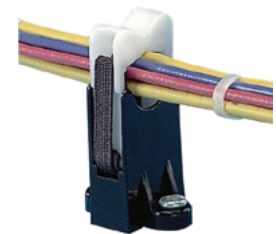

Part Number	Description	Compatible QB Components	Std. Pkg. Qty.
RER.5-S6-X	Elastic retainer with replaceable elastic band. Suitable for 0.5" maximum bundle capacity.	QB-BASE175-Q and QB-S6-500-C	10
RER.75-S6-X	Elastic retainer with replaceable elastic band. Suitable for 0.75" maximum bundle capacity.		
RER1.25-S6-X	Elastic retainer with replaceable elastic band. Suitable for 1.25" maximum bundle capacity.		



**Like what you see and want more?**

Visit [www.panduit.com](http://www.panduit.com) for the full offering of Panduit products

# CABLE TIE TOOLS

---

Manual Cable Tie Installation Tools .....	87
Pneumatic Cable Tie Hand Tools .....	87
Automatic Cable Tie Installation Systems .....	88
PLT-XMR Reel-Fed Cable Ties .....	89
BT-XMR Reel-Fed Cable Ties .....	90





The GTS-E cable tie tools are the **ultimate solution** for anyone looking to **streamline** their cable tie installation process. With **advanced features** such as reduced installation stress and high-quality installation, our tool makes it easier than ever to install cable ties quickly and efficiently.



### Manual Cable Tie Installation Tools

Panduit provides the most preferred hand-operated tools in the industry. They promote worker safety, help reduce downtime, improve productivity and provide the lowest total installed cost. Our offering of versatile tools can be used for production, maintenance, or construction applications.

- Tool controlled tension provides flush cut-off and speeds
- Lightweight and balanced ergonomic design
- Excellent tools for low to medium volume applications
- Easy to change tension adjustment and easy to operate
- QPL per Mil. Std. SAE AS81306 and Mil. Spec. SAE AS90387



Part number	Installs Cable Tie Cross Sections	Weight oz (g)	Body Construction	Color	Mil Spec Number	Std. Pkg. Qty.
<b>BEST SELLER</b> GTS-E	SM, M, I, S	10.4 (294)	Impact Resistant Plastic Resin	Body: Dark Gray Handle/Gripper: Black Tension Knob: Black	MS90387-1	1
GS2B-E		13.6 (385)	Metal	Body: Light Gray Handle/Gripper: Black Tension Knob: Black	MS90387-1	
<b>BEST SELLER</b> GTH-E	S, HS, LH, H	11.9 (337)	Impact Resistant Plastic Resin	Body: Dark Gray Handle/Gripper: Red Tension Knob: Red	MS90387-2	
<b>BEST SELLER</b> GS4H-E		15.3 (435)	Metal	Body: Light Gray Handle/Gripper: Red Tension Knob: Red	MS90387-2	

Cable tie cross section sizes: SM = Subminiature, M = Miniature, I = Intermediate, S = Standard LH = Light-Heavy, and H = Heavy

### Pneumatic Cable Tie Hand Tools



PTS



PTH



PPTS

Part number	Installs Cable Tie Cross Sections	Description	Std. Pkg. Qty.
PTS	Subminiature, Miniature, Intermediate, Standard	Pneumatic hand tool with ergonomic design. Impact resistant resin housing. Color identification: Black trigger, handle, label and tension selector knob	1
PTH	Standard, Heavy-Standard, Light-Heavy, Heavy	Pneumatic hand tool with ergonomic design. Impact resistant resin housing. Color identification: Red trigger, handle, label and tension selector knob	
PPTS	Standard, Heavy-Standard, Light-Heavy, Heavy	Pneumatic hand tool. Metal housing. Color identification: Black trigger, label and tension selector knob. This tool is field serviceable. Replacement part kits can be part of a scheduled maintenance program	

### PAT 4.0 Automatic Cable Tie Installation Systems

The complete line of Panduit automatic cable tie installation systems offers a superior solution for high volume harness, assembly, fastening and packaging applications. These ergonomic systems increase productivity, provide consistent performance, and reduce activities that lead to repetitive motion injuries.

#### Tool Heads

- Durable, one-piece cable tie tip collector
- Includes tension adjustment
- Right or left hand operation
- Built-in safety interlock prevents false triggering if anything obstructs jaw path



Part Number	Max Bundle Diameter		Dispenser	Transfer Hose	Used with Cable Ties	Std. Pkg. Qty.
	In.	mm				
<b>BEST SELLER</b> PAT1M4.0	0.82	21	PDM4.0	PHM1, PHM2, PHM3, PHM4	PLT1M-XMR	1
<b>BEST SELLER</b> PAT1.5M4.0	1.31	33			PLT1.5M-XMR	

#### Dispensers

- Microprocessor based controller monitors system performance through a touch screen display. Provides production data and reporting, including error detection and cycle count for improved reliability
- Online HELP menu through LCD display in seven languages (English, Spanish, German, Italian, French, Czech, Japanese), is user-friendly for quick and simple training.



Part Number	Used with Tool Head	Description	Std. Pkg. Qty.
<b>BEST SELLER</b> PDM4.0	PAT1M4.0 PAT1.5M4.0 PAT1M4.0-BT PAT1.5M4.0-BT	Stationary dispenser with electronic display. Online help menu. System operates on 65 psig (minimum) non-lubricated filtered air and 100 – 24 FAC/TP or 60 MHz	1

#### Transfer Hose

Part number	Used with Tool Head	Description	Length		Std. Pkg. Qty.
			ft	m	
PHM3	PAT1M4.0 PAT1.5M4.0 PAT1M4.0-BT PAT1.5M4.0-BT	Transfers cable tie and signal from dispenser to tool head; electrical connectors designed for easy attachment provide a reliable, secure connection	10.0	3	1







### PLT-XMR Reel-Fed Cable Ties

- Panduit provides the most preferred hand-operated tools in the industry
- They promote worker safety, help reduce downtime, improve productivity and provide the lowest total installed cost
- Our offering of versatile tools can be used for production, maintenance, or construction applications
- Continuous feeding allows for high productivity and reduced downtime



Part number	Material	Color	For Use With PAT4.0 Tool Head	Max Bundle Diameter In. (mm)	Length In. (mm)	Width In. (mm)	Min Loop Tensile Strength lbs (N)	AH-2 Plenum Rated	Continuous Use Temperature Rating
<b>BEST SELLER</b> PLT1M-XMR	Nylon 6.6	Natural	PAT1M4.0	.82 (21)	4.0 (102)	0.10 (2.5)	18 (80)	Yes	-76° F (-60° C) to 185° F (85° C)
<b>BEST SELLER</b> PLT1M-XMR0	Weather Resistant Nylon 6.6	Black							
PLT1M-XMR00*	Heat Stabilized Nylon 6.6								
PLT1M-XMR30	Heat Stabilized Nylon 6.6						No	-76° F (-60° C) to 239° F (115° C)	
<b>BEST SELLER</b> PLT1.5M-XMR	Nylon 6.6	Natural	PAT1.5M4.0	1.31 (33)	5.6 (142)			Yes	-76° F (-60° C) to 185° F (85° C)
<b>BEST SELLER</b> PLT1.5M-XMR0	Weather Resistant Nylon 6.6	Black							
<b>BEST SELLER</b> PLT1.5M-XMR30	Heat Stabilized Nylon 6.6								

\*Military grade weather resistant material

Note: PLT\_XMR cable ties (natural, 00, and colors) are Class 2 Mil. Spec. per AS23190 and AS33671  
Please visit [www.panduit.com](http://www.panduit.com) for additional colors



**Like what you see and want more?**

Visit [www.panduit.com](http://www.panduit.com) for the full offering of Panduit products



### BT-XMR Reel-Fed Cable Ties

- Continuously molded cable ties (5,000 ties/reel) provide continuous feeding for high productivity and reduced downtime due to fewer reel changes
- Reel-fed cable ties with exclusive stainless steel locking barb and 30 lbs. minimum loop tensile strength permit higher tension for demanding applications
- Metal locking barb and tie body design provide greater bundle tightness, reducing both rotational and lateral movement of the tie

- Reel-fed cable ties in Nylon 6.6 material (Natural color) are UL Listed for use in plenum or air handling spaces per NEC
- Reel-fed cable ties in Nylon 6.6 material (black color) are weather resistant and UL listed for indoor/outdoor use



BT-XMR



BT\_XMR (0, 30)

Part number	Material	Color	For Use With PAT4.0-BT Tool Head	Max Bundle Diameter In. (mm)	Length In. (mm)	Width In. (mm)	Min Loop Tensile Strength lbs. (N)	AH-2 Plenum Rated	Continuous Use Temperature Rating
BT1M-XMR	Nylon 6.6	Natural	PAT1M4.0-BT	0.82 (21)	4.0 (102)	0.190 (4.8)	30 (133)	Yes	-76° F (-60° C) to 185° F (85° C)
BT1M-XMR0	Weather Resistant Nylon 6.6	Black							
BT1M-XMR30	Heat Stabilized Nylon 6.6		PAT1.5M4.0-BT	1.31 (33)	5.6 (142)	0.100 (2.5)		No	-76° F (-60° C) to 239° F (115° C)
BT1.5M-XMR	Nylon 6.6	Natural						Yes	-76° F (-60° C) to 185° F (85° C)
BT1.5M-XMR30	Heat Stabilized Nylon 6.6	Black					No	-76° F (-60° C) to 239° F (115° C)	



**Like what you see and want more?**

Visit [www.panduit.com](http://www.panduit.com) for the full offering of Panduit products

# IDENTIFICATION PRODUCTS

---

PXE™ Series Mobile Printers.....	92-93
PXE™ Turn-Tell® Label Cassettes.....	94
PXE™ Continuous Self-Laminating Label Cassettes .....	94
PXE™ Die-Cut Self-Laminating Label Cassettes.....	95
PXE™ Continuous Heat Shrink Label Cassettes.....	96
PXE™ Continuous Tape Cassettes.....	97
PXE™ Nylon Cloth Tape Cassette.....	98
PXE™ Marker Plate Label Cassettes .....	99
PXE™ Non-Adhesive Polyester Component Labels .....	99
PXE™ Continuous Terminal Block Label Cassettes .....	100
P1™ Label Cassettes for PanTher™ LS8E/LS8EQ Hand-Held Thermal Transfer Printers .....	100
TDP43ME Thermal Transfer Desktop Printer .....	103
TDP43HET and TDP46HET Thermal Transfer Desktop Printers .....	103
Thermal Transfer Labels and Tape .....	104
Laser/Ink Jet Self-Laminating Labels .....	107
Stainless Steel Marker Plates.....	108
PES400 Embossing System .....	108
Embossing Tools and Tapes .....	108

Product Showcase

Abrasion Protection

Cable Cleats

Cable Ties

Cable Tie Accessories

Cable Tie Tools

Identification Products

Power Connectors

Grounding Connectors

Safety Solutions

Stainless Steel Ties

Terminals

Wiring Duct

Part Number Index

### PXE™ Series MP300 Mobile Printer

Do your job smarter, faster and easier with PXE Series Mobile Printers. This full line of advanced identification printers combine Panduit's industry-leading performance and field-tested durability with Epson's world-class printing technology.

- 360 dpi print resolution
- Automatic cutter with full or half cut – saves time and effort for everyday labeling
- Fast 1.4-inch per second print speed – maximize your productivity and lower your installation costs
- Up to 1.5-inch wide label sizes
- Prints die-cut and continuous labels – choose from a wide variety of labeling materials
- USB connectivity
- Prints from Easy-Mark Plus™ Labeling Software
- Includes magnetic attachment accessory
- Includes rechargeable Li-ion battery pack



MP300

Part Number	Description
<b>BEST SELLER</b> <b>MP300</b>	Includes MP300 printer, one (1) cassette of S100X150VAM self-laminating labels, rechargeable Li-ion Battery Pack, hard carrying case, AC power adapter, USB cable, magnetic attachments and quick reference card
<b>MP300-ACS</b>	MP300-ACS Replacement 120-240 VAC universal power adapter module with power cord for North America for MP300 printer
<b>MP-BATT</b>	Replacement Li-ion rechargeable battery pack for MP200 and MP300 printers
<b>MP-CASE</b>	Replacement hard carrying case for MP200 and MP300 printers
<b>PTR-CLN</b>	Printer cleaning kit - contains (1) cleaning pen, (8) cleaning solution soaked wipes, (8) foam swabs pre-saturated with cleaning solution, MSDS, and cleaning instructions

### PXE™ Series MP200 and MP200-KIT Mobile Printers

- Shared MP Cassette Platform
- 180 dpi print resolution
- Automatic cutter with full or half cut
- Fast 1.2-inch per second print speed
- Up to 1.0-inch wide continuous label media
- USB connectivity
- Prints from Easy-Mark Plus™ Labeling Software
- Application specific label modes



MP200



MP200-KIT

Part Number	Description
<b>MP200</b>	Rugged, high performance, economical industrial printer that features a large LCD backlit screen, custom label modes, barcodes and symbols, includes the printer, continuous label cassette, and quick reference card
<b>MP200-KIT</b>	Rugged, high performance, economical industrial printer that features a large LCD backlit screen, custom label modes, barcodes and symbols. Includes the printer, a continuous label cassette, hard carrying case, rechargeable battery pack, magnetic feet, USB cable, and power adapter
<b>MP-CASE</b>	Replacement hard carrying case for MP200 and MP300 printers
<b>MP-BATT</b>	Replacement Li-ion rechargeable battery pack for MP200 and MP300 printers
<b>MP-ACS-1</b>	ACS replacement 120-240 VAC universal power adapter module with power cord for North America for MP100, MP200, and MP200-KIT printers
<b>PTR-CLN</b>	Printer cleaning kit - contains (1) cleaning pen, (8) cleaning solution soaked wipes, (8) foam swabs pre-saturated with cleaning solution, MSDS, and cleaning instructions

### PXE™ Series MP100 Mobile Printers

- Automatic cutter
- USB and Bluetooth Connectivity
- Integration with Fluke LinkWare™ Live
- Prints from Easy-Mark Plus™ Labeling Software
- Up to 1.0-inch wide continuous label sizes
- Prints from mobile labeling apps
- Compact size



Part Number	Description
<b>MP100</b>	Includes MP100 printer, protective impact bumper, 1 cassette of T100X000VPM-BK continuous vinyl tape, AC power adapter, USB cable, and quick reference card
<b>MP-ACS-1</b>	Replacement 120-240 VAC universal power adapter module with power cord for North America for MP100 and MP200 printers
<b>MP100-IB</b>	Replacement impact bumper for MP100 and MP100/E printers
<b>PTR-CLN</b>	Printer cleaning kit - contains (1) cleaning pen, (8) cleaning solution soaked wipes, (8) foam swabs pre-saturated with cleaning solution, MSDS, and cleaning instructions

### PXE™ Series MP75 Mobile Printer

- 180 dpi print resolution
- Fast 0.25-inch per second print speed
- Up to 0.75-inch wide continuous label media
- Manual push button cutter
- Application specific label modes



Part Number	Description
<b>MP75</b>	Compact entry level industrial printer that features custom label modes, a qwerty keyboard, backlit LCD screen, and a large library of barcodes and custom symbols. Includes the lightweight printer, a continuous label cassette, and quick reference card
<b>PTR-CLN</b>	Printer cleaning kit – contains (1) cleaning pen, (8) cleaning solution soaked wipes, (8) foam swabs pre-saturated with cleaning solution, MSDS, and cleaning instructions



**Like what you see and want more?**

Visit [www.panduit.com/mobileprinters](http://www.panduit.com/mobileprinters) for the full offering of Panduit products



### PXE™ Turn-Tell® Label Cassettes **PATENTED**

- Fast-loading label cassette includes both label material and ribbon to make changing labels easy
- Innovative label design allows labels to rotate for visibility from any angle, and for repositioning on the wire/cable to align legends and improve aesthetics
- Labels can be easily installed on existing terminated wires and assemblies without disconnecting the wires/cables
- Print-On Area Color: Black on White



Polymer Film (V1) -40°F to 150°F (-40°C to 66°C)

Part Number	Description	Qty. of Labels per Cassette	Printer Compatibility				Width		Length		Min. Cable O.D.		Max. Cable O.D.		Wire/Cable Size Range	Std. Pkg. Qty.	Std. Ctn. Qty.	
			MP 75	MP 100	MP 200	MP 300	In.	mm	In.	mm	In.	mm	In.	mm				
<b>R100X075V1M</b>	PXE Cassette, Turn-Tell Self-Laminating Label, Vinyl, 1.00" W x 0.75" H, 0.25" Print On Area	175								0.75	19.1	0.12	3.1	0.16	4.1	Cat. 6 28 AWG/ 18 – 14 AWG		
<b>R100X125V1M</b>	PXE Cassette, Turn-Tell Self-Laminating Label, Vinyl, 1.00" W x 1.25" H, 0.38" Print On Area	125								1.25	31.8	0.16	4.1	0.22	5.6	Cat. 3 UTP/12 – 10 AWG		
<b>BEST SELLER</b> <b>R100X150V1M</b>	PXE Cassette, Turn-Tell Self-Laminating Label, Vinyl, 1.00" W x 1.5" H, 0.5" Print On Area	100	N	N	N	Y	1.00	25.4		1.5	38.1	0.22	5.6	0.28	7.1	Cat. 5e UTP/ Cat. 6 UTP/ Cat. 6A UTP	1	5
<b>R100X225V1M</b>	PXE Cassette, Turn-Tell Self-Laminating Label, Vinyl, 1.00" W x 2.25" H, 0.75" Print On Area	75								2.25	57.2	0.28	7.1	0.39	9.9	Cat. 6 FTP/ Cat. 6 UTP/ Cat. 6A FTP/8-4 AWG		

### PXE™ Continuous Self-Laminating Label Cassettes

- Fast-loading label cassette includes both label material and ribbon to make changing labels easy
- Self-laminating adhesive labels for wire/cable identification include a white print-on area and clear overlaminates
- Print-On Area Color: Black on White



Self-Laminating Vinyl (VA) -40°F to 150°F (-40°C to 66°C)

Part Number	Description	Printer Compatibility				Width		Length		Print-On Area Height		Min. Cable O.D.		Max. Cable O.D.		Wire/Cable Size Range	Std. Pkg. Qty.	Std. Ctn. Qty.		
		MP 75	MP 100	MP 200	MP 300	In.	mm	In.	mm	In.	mm	In.	mm	In.	mm					
<b>S000X100VAM</b>	PXE Cassette, Continuous Self-Laminating Tape, Vinyl, 1.0" W x 26' L		Y	Y		0.945	24.0			0.315	8	0.10	2.5	0.20	5.1	12 – 10 AWG				
<b>S000X150VAM</b>	PXE Cassette, Continuous Self-Lam Tape, Vinyl, 1.5" W x 26' L, White	N			Y	1.417	36.0		26.2	8.0		0.512	13.0	0.16	4.0	0.32	8.1	Cat. 5e/ Cat. 6	1	5

### PXE™ Die-Cut Self-Laminating Label Cassettes

- Fast-loading label cassette includes both label material and ribbon to make changing labels easy
- Self-laminating adhesive labels for wire/cable identification includes a white print-on area and clear over laminate
- Print-On Area Color: Black on White

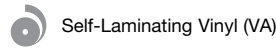

-40°F to 150°F (-40°C to 66°C)

Product Showcase

Abrasion Protection

Cable Cleats

Cable Ties

Cable Tie Accessories

Cable Tie Tools

Identification Products

Power Connectors

Grounding Connectors

Safety Solutions

Stainless Steel Ties

Terminals

Wiring Duct

Part Number Index

Part Number	Description	Quantity of Labels Per Cassette	Printer Compatibility				Width		Length		Print-On Area Height		Min. Cable O.D.		Max. Cable O.D.		Wire/Cable Size Range	Std. Pkg. Qty.	Std. Ctn. Qty.
			MP 75	MP 100	MP 200	MP 300	In.	mm	In.	mm	In.	mm	In.	mm	In.	mm			
<b>S050X075VAM</b>	PXE Cassette, Self-Laminating Label, Vinyl, 0.50" W x 0.75" H, 0.25" Print On Area	425							0.75	19.1	0.25	6.4	0.08	2.0	0.16	4.0	Cat. 6 28 AWG/ 18 – 14 AWG		
<b>S050X125VAM</b>	PXE Cassette, Self-Laminating Label, Vinyl, 0.50" W x 1.25" H, 0.38" Print On Area	200					0.50	12.7	1.25	31.8	0.38	9.7	0.12	3.1	0.28	7.0	Cat. 3 UTP/ 12 – 10 AWG		
<b>S050X150VAM</b>	PXE Cassette, Self-Laminating Label, Vinyl, 0.50" W x 1.50" H, 0.50" Print On Area	175							1.50	38.1	0.50	12.7	0.16	4.0	0.32	8.1	Cat. 5e UTP/ Cat. 6 UTP/Cat. 6A UTP/ Cat. 5e FTP/ 10 – 6 AWG		
<b>S100X075VAM</b>	PXE Cassette, Self-Laminating Label, Vinyl, 1.00" W x 0.75" H, 0.25" Print On Area	300							0.75	19.1	0.25	6.4	0.08	2.0	0.16	4.0	Cat. 6 28 AWG/ 18 – 14 AWG		
<b>S100X125VAM</b>	PXE Cassette, Self-Laminating Label, Vinyl, 1.00" W x 1.25" H, 0.38" Print On Area	200	N	N	N	Y			1.25	31.8	0.38	9.7	0.12	3.1	0.28	7.0	Cat. 3 UTP/ 12 – 10 AWG	1	5
<b>BEST SELLER</b> <b>S100X150VAM</b>	PXE Cassette, Self-Laminating Label, Vinyl, 1.00" W x 1.50" H, 0.50" Print On Area	175							1.50	38.1	0.50	12.7	0.16	4.0	0.32	8.1	Cat. 5e UTP/Cat. 6 UTP/Cat. 6A UTP/ Cat. 5e FTP/ 10 – 6 AWG		
<b>S100X225VAM</b>	PXE Cassette, Self-Laminating Label, Vinyl, 1.00" W x 2.25" H, 0.75" Print On Area	125					1.00	25.4	2.25	57.2	0.75	19.1	0.24	6.1	0.48	12.2	Cat. 6 FTP/ Cat. 6A UTP/ Cat. 6A FTP/8 – 4 AWG		
<b>S100X400VAM</b>	PXE Cassette, Self-Laminating Label, Vinyl, 1.00" W x 4.00" H, 1.00" Print On Area	70							4.00	101.6	1.00	25.4	0.32	8.1	0.95	24.3	2 – 1 AWG		
<b>S100X650VAM</b>	PXE Cassette, Self-Laminating Label, Vinyl, 1.00" W x 6.50" H, 1.50" Print On Area	45							6.50	165.1	1.50	38.1	0.48	12.2	1.59	40.4	1/0-250 MCM		

### PXE™ Continuous Heat Shrink Label Cassettes



- Fast-loading label cassette includes both label material and ribbon to make changing labels easy
- Non-adhesive flattened heat shrinkable polyolefin for wire/cable identification

Heat Shrinkable Polyolefin (H1, H2, HP, HX)

H1, H2: -40°F to 257°F (-40°C to 125°C)  
HP, HX: -67°F to 257°F (-55°C to 125°C)

Part Number	Description	Shrink Ratio	Mil Spec	Printer Compatibility				Ribbon & Material Color	Width		Length		Min. Cable O.D.		Max. Cable O.D.		Wire/Cable Size Range	Std. Pkg. Qty.	Std. Ctn. Qty.
				MP 75	MP 100	MP 200	MP 300		In.	mm	In.	mm	In.	mm	In.	mm			
H000X025H1M	PXE Cassette, Continuous Heat Shrink Tubing, Mil Grade Polyolefin, 0.25" W x 8' L	3:1	Y	Y				Black on White	0.27	6.8			0.06	1.4	0.16	4.1	22 – 18 AWG	1	5
H000X025H2M	PXE Cassette, Continuous Heat Shrink Tubing, Mil Grade Polyolefin, 0.25" W x 8' L							Black on Yellow											
H000X034H1M	PXE Cassette, Continuous Heat Shrink Tubing, Mil Grade Polyolefin, 0.34" W x 8' L							Black on White											
H000X034H2M	PXE Cassette, Continuous Heat Shrink Tubing, Mil Grade Polyolefin, 0.34" W x 8' L							Black on Yellow											
H000X044H1M	PXE Cassette, Continuous Heat Shrink Tubing, Mil Grade Polyolefin, 0.44" W x 8' L							Black on White											
H000X044H2M	PXE Cassette, Continuous Heat Shrink Tubing, Mil Grade Polyolefin, 0.44" W x 8' L							Black on Yellow											
H000X064HPM	PXE Cassette, 2:1 Continuous Heat Shrink Tubing, Polyolefin, 0.64" W x 8.0' L, White	2:1	N	N				Black on White	0.71	18	8.2	2.5	0.21	5.3	0.43	10.9	8 – 2 AWG	1	5
H000X064HXM	PXE Cassette, 2:1 Continuous Heat Shrink Tubing, Polyolefin, 0.64" W x 8.0' L, Yellow							Black on Yellow											
H000X084HPM	PXE Cassette, 2:1 Continuous Heat Shrink Tubing, Polyolefin, 0.84" W x 8.0' L, White							Black on White											
H000X084HXM	PXE Cassette, 2:1 Continuous Heat Shrink Tubing, Polyolefin, 0.84" W x 8.0' L, Yellow							Black on Yellow											
H000X134HPM	PXE Cassette, 2:1 Continuous Heat Shrink Tubing, Polyolefin, 1.34" W x 8.0' L, White							Black on White											
H000X134HXM	PXE Cassette, 2:1 Continuous Heat Shrink Tubing, Polyolefin, 1.34" W x 8.0' L, Yellow							Black on Yellow											

## PXE™ Continuous Tape Cassettes

- Fast-loading Label Cassette includes both label material and ribbon to make changing labels easy
- Print custom pipe markers, voltage markers, signs, bin markers, and network identification labels on demand
- For flat label applications only



Vinyl Material (VXM & VPM):  
-40°F to 194°F (-40°C to 90°C)

Polyester Material (BPM, BQM, BSM, BUM, BWM, BXM, BYM, YKM): -40°F to 257°F (-40°C to 125°C)

Magnetic Material (MPM & MXM):  
14°F to 104°F (-10°C to 40°C)



Part Number	Description	Printer Compatibility				Ribbon & Material Color	Width		Length		Std. Pkg. Qty.	Std. Ctn. Qty.
		MP 75	MP 100	MP 200	MP 300		In.	mm	Ft.	m		
T024X000BPM-BK	PXE Cassette, Continuous Tape, Polyester, 0.24" W x 30' L, Black on White					Black on White	0.229	5.8	30	9.1		
T038X000VPM-BK	PXE Cassette, Continuous Tape, Vinyl, 0.38" W x 23' L, Black on White					Black on White			23	7.0		
T038X000BPM-BK	PXE Cassette, Continuous Tape, Polyester, 0.38" W x 30' L, Black on White					Black on White			30	9.1		
T038X000VXM-BK	PXE Cassette, Continuous Tape, Vinyl, 0.38" W x 23' L, Black on Yellow					Black on Yellow	0.354	9.0	23	7.0		
T038X000BXM-BK	PXE Cassette, Continuous Tape, Polyester, 0.38" W x 30' L, Black on Yellow					Black on Yellow						
T038X000YKM-BK	PXE Cassette, Continuous Tape, Polyester, 0.38" W x 30' L, Black on Clear					Black on Clear			30	9.1		
T038X000BYM-WH	PXE Cassette, Continuous Tape, Polyester, 0.38" W x 30' L, White on Black					White on Black						
T050X000VPM-BK	PXE Cassette, Continuous Tape, Vinyl, 0.50" W x 23' L, Black on White					Black on White			23	7.0		
T050X000BPM-BK	PXE Cassette, Continuous Tape, Polyester, 0.50" W x 30' L, Black on White					Black on White			30	9.1		
T050X000VXM-BK	PXE Cassette, Continuous Tape, Vinyl, 0.50" W x 23' L, Black on Yellow					Black on Yellow	0.472	12.0	23	7.0		
T050X000BXM-BK	PXE Cassette, Continuous Tape, Polyester, 0.50" W x 30' L, Black on Yellow					Black on Yellow						
T050X000YKM-BK	PXE Cassette, Continuous Tape, Polyester, 0.50" W x 30' L, Black on Clear					Black on Clear			30	9.1		
T050X000BYM-WH	PXE Cassette, Continuous Tape, Polyester, 0.50" W x 30' L, White on Black					White on Black						
T075X000VPM-BK	PXE Cassette, Continuous Tape, Vinyl, 0.75" W x 23' L, Black on White					Black on White			23	7.0		
T075X000BPM-BK	PXE Cassette, Continuous Tape, Polyester, 0.75" W x 30' L, Black on White					Black on White			30	9.1		
T075X000VXM-BK	PXE Cassette, Continuous Tape, Vinyl, 0.75" W x 23' L, Black on Yellow		Y	Y		Black on Yellow	0.710	18.0	23	7.0		
T075X000BXM-BK	PXE Cassette, Continuous Tape, Polyester, 0.75" W x 30' L, Black on Yellow					Black on Yellow						
T075X000YKM-BK	PXE Cassette, Continuous Tape, Polyester, 0.75" W x 30' L, Black on Clear					Black on Clear			30	9.1		
T075X000BYM-WH	PXE Cassette, Continuous Tape, Polyester, 0.75" W x 30' L, White on Black					White on Black						
T100X000MPM-BK	PXE Cassette, Continuous Tape, Magnetic, 1.00" W x 4.9' L, Black on White					Black on White			4.9	1.5		
T100X000MXM-BK	PXE Cassette, Continuous Tape, Magnetic, 1.00" W x 4.9' L, Black on Yellow					Black on Yellow						
T100X000VPM-BK	PXE Cassette, Continuous Tape, Vinyl, 1.00" W x 23' L, Black on White					Black on White			23	7.0	1	5
T100X000BPM-BK	PXE Cassette, Continuous Tape, Polyester, 1.00" W x 30' L, Black on White					Black on White			30	9.1		
T100X000VXM-BK	PXE Cassette, Continuous Tape, Vinyl, 1.00" W x 23' L, Black on Yellow					Black on Yellow			23	7.0		
T100X000BXM-BK	PXE Cassette, Continuous Tape, Polyester, 1.00" W x 30' L, Black on Yellow					Black on Yellow	0.945	24.0				
T100X000YKM-BK	PXE Cassette, Continuous Tape, Polyester, 1.00" W x 30' L, Black on Clear					Black on Clear						
T100X000BQM-WH	PXE Cassette, Continuous Tape, Polyester, 1.00" W x 30' L, White on Blue					White on Blue						
T100X000BSM-WH	PXE Cassette, Continuous Tape, Polyester, 1.00" W x 30' L, White on Green					White on Green			30	9.1		
T100X000BUM-BK	PXE Cassette, Continuous Tape, Polyester, 1.00" W x 30' L, Black on Orange					Black on Orange						
T100X000BWM-WH	PXE Cassette, Continuous Tape, Polyester, 1.00" W x 30' L, White on Red					White on Red						
T100X000BYM-WH	PXE Cassette, Continuous Tape, Polyester, 1.00" W x 30' L, White on Black					White on Black						
T150X000MPM-BK	MP Cassette, Continuous Tape, Magnetic, 1.50" W x 4.9' L, Black on White					Black on White			4.9	1.5		
T150X000MXM-BK	MP Cassette, Continuous Tape, Magnetic, 1.50" W x 4.9' L, Black on Yellow					Black on Yellow						
T150X000VPM-BK	MP Cassette, Continuous Tape, Vinyl, 1.50" W x 23' L, Black on White					Black on White			23	7.0		
T150X000BPM-BK	MP Cassette, Continuous Tape, Polyester, 1.50" W x 30' L, Black on White					Black on White			30	9.1		
T150X000VXM-BK	MP Cassette, Continuous Tape, Vinyl, 1.50" W x 23' L, Black on Yellow					Black on Yellow			23	7.0		
T150X000BXM-BK	MP Cassette, Continuous Tape, Polyester, 1.50" W x 30' L, Black on Yellow					Black on Yellow	1.471	36.0				
T150X000YKM-BK	MP Cassette, Continuous Tape, Polyester, 1.50" W x 30' L, Black on Clear					Black on Clear						
T150X000BQM-WH	MP Cassette, Continuous Tape, Polyester, 1.50" W x 30' L, White on Blue					White on Blue						
T150X000BSM-WH	MP Cassette, Continuous Tape, Polyester, 1.50" W x 30' L, White on Green					White on Green			30	9.1		
T150X000BUM-BK	MP Cassette, Continuous Tape, Polyester, 1.50" W x 30' L, Black on Orange					Black on Orange						
T150X000BWM-WH	MP Cassette, Continuous Tape, Polyester, 1.50" W x 30' L, White on Red					White on Red						
T150X000BYM-WH	MP Cassette, Continuous Tape, Polyester, 1.50" W x 30' L, White on Black					White on Black						

- Product Showcase
- Abrasion Protection
- Cable Cleats
- Cable Ties
- Cable Tie Accessories
- Cable Tie Tools
- Identification Products
- Power Connectors
- Grounding Connectors
- Safety Solutions
- Stainless Steel Ties
- Terminals
- Wiring Duct
- Part Number Index

### PXE™ Nylon Cloth Tape Cassettes

- Fast-loading Label Cassette includes both label material and ribbon to make changing labels easy
- Non-laminated adhesive labels for wire/cable identification

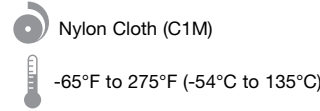

### Die-Cut Nylon Cloth Labels

Part Number	Description	Printer Compatibility				Ribbon & Material Color	Width		Length		Min. Cable O.D.		Max. Wire O.D.		Wire Range	Labels Per Cassette	Std. Pkg. Qty.	Std. Ctn. Qty.
		MP 75	MP 100	MP 200	MP 300		In.	mm	In.	mm	In.	mm	In.	mm				
<b>N050X075C1M</b>	PXE Cassette, Comp Label, Adhesive Nylon Cloth, 0.50" W x .75" H, White					Black on White	0.50	12.7						12-10 AWG	275	1	5	
<b>N100X075C1M</b>	PXE Cassette, Comp Label, Adhesive Nylon Cloth, 1.00" W x .75" H, White	N	N	N	Y				0.75	19.1	0.12	3.1	0.16					4.1
<b>N100X125C1M</b>	PXE Cassette, Comp Label, Adhesive Nylon Cloth, 1.00" W x 1.25" H, White						1.00	25.4							10-6 AWG	180		

### Continuous Nylon Cloth Tape

Part Number	Description	Printer Compatibility				Print-On Area Color	Height		Length		Std. Pkg. Qty.	Std. Ctn. Qty.
		MP75	MP100	MP200	MP300		In.	mm	Ft.	m		
<b>T050X000C1M-BK</b>	PXE Cassette, Continuous Tape, Nylon Cloth, 0.50" W x 19' L, Black on White					Black on White	0.465	11.82				
<b>T075X000C1M-BK</b>	PXE Cassette, Continuous Tape, Nylon Cloth, 0.75" W x 19' L, Black on White		N	Y	Y		0.702	17.82	19	6	1	5
<b>T100X000C1M-BK</b>	PXE Cassette, Continuous Tape, Nylon Cloth, 1.00" W x 19' L, Black on White		N				0.938	23.82				



### PXE™ Marker Plate Label Cassettes

- Fast-loading PXE™ Label Cassette includes both label material and ribbon to make changing labels easy
- Non-adhesive and halogen free; used to identify wires, cables, equipment, and many other applications
- Designed for use on larger diameter wire/cables and may be applied after all terminations are complete
- Attachable in horizontal or vertical orientation
- Meets requirements for MIL-STD-202G, Method 215K, Soutlion A, C and D
- Meets the outgassing requirements of ASTM E-595 suitable for use in air handling spaces



Polyester/Polyolefin (Y6, Y7) -40°F to 180°F (-40°C to 82°C)

Part Number	Description	Printer Compatibility				Ribbon & Material Color	Width		Length		Print-On Area Width		Recommended Cable Tie		Labels Per Cassette	Std. Pkg. Qty.	Std. Ctn. Qty.
		MP 75	MP 100	MP 200	MP 300		In.	mm	In.	mm	In.	mm	Vertical	Horizontal			
<b>M300X050Y6M</b>	PXE Cassette, Marker plate, polyester, 3.0" W x .50" H, Yellow	N	N	N	Y	Black on Yellow	3.00	76.2	0.50	12.7	1.80	45.7	PLT2.5I-C	PLT2.5I-C	65	1	5
<b>M300X050Y7M</b>	PXE Cassette, Marker plate, polyester, 3.0" W x .50" H, White	N	N	N	Y	Black on White											

### PXE™ Non-Adhesive Polyester Component Labels

- Fast-loading Label Cassette includes both label material and ribbon to make changing labels easy
- Die-cut labels designed to provide maximum aesthetic quality and appearance
- Use for identifying patch panel, faceplates, punchdown blocks, and other network system hardware



Non-Adhesive Polyester (Y1) -10°F to 311°F (-23°C to 155°C)

Part Number	Description	Labels per Cassette	Printer Compatibility				Color	Width		Height		Application	Std. Pkg. Qty.	Std. Ctn. Qty.
			MP75	MP100	MP200	MP300		In.	mm	In.	mm			
<b>C195X040Y1M</b>	PXE Cassette, Comp Label, Non-Adhesive Polyester, 1.95" W x .40" H, White	125	N	N	N	Y	White	1.95	49.5	0.4	10.2	Single-gang faceplate	1	5
<b>C261X035Y1M</b>	PXE Cassette, Comp Label, Non-Adhesive Polyester, 2.61" W x .35" H, White	100						2.61	66.3	0.35	8.9	4-port		

### PXE™ Continuous Terminal Block Label Cassettes

- Fast-loading Label Cassette includes both label material and ribbon to make changing labels easy
- Print terminal block labels ranging in size from 0.24 inches to 0.38 inches

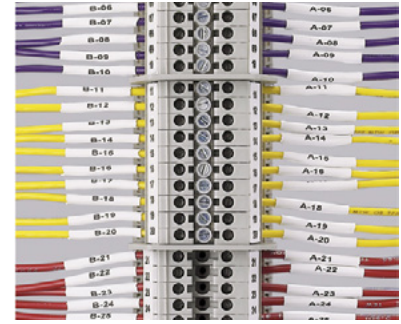

 Polyolefin (FJM)  -40°F to 180°F (-40°C to 82°C)

Part Number	Description	Printer Compatibility				Print-On Area Color	Height		Length		Std. Pkg. Qty.	Std. Ctn. Qty.
		MP75	MP100	MP200	MP300		In.	mm	Ft.	m		
<b>T024X000FJM-BK</b>	PXE Cassette, Continuous Tape, Polyolefin, 0.24" W x 23' L, Black on White	Y	Y	Y	Y	Black on White	0.229	5.82	23	7	1	5
<b>T038X000FJM-BK</b>	PXE Cassette, Continuous Tape, Polyolefin, 0.38" W x 23' L, Black on White						0.347	8.82				

### P1™ Turn-Tell® Label Cassettes for PanTher™ LS8E/LS8EQ Hand-Held Thermal Transfer Printers

**PATENTED**

- Fast loading P1™ Label Cassette includes both label material and ribbon to make changing labels easy
- Innovative label design allows labels to rotate for visibility from any angle, and for repositioning on the wire/cable to align legends and improve aesthetics
- Labels can be easily installed on existing terminated wires and assemblies without disconnecting the wires/cables
- Print-On Area Color: Black on White

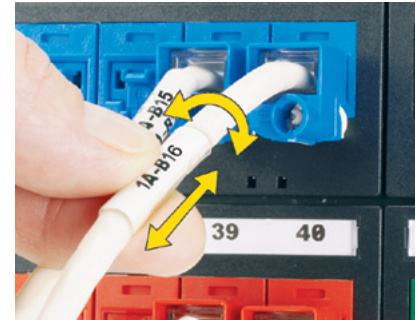

 -40°F to 200°F (-40°C to 93°C)

Part Number	Width		Length		Print-On Area Height		Min. Cable O.D.		Max. Cable O.D.		Wire Range	Labels Per Cassette	Std. Pkg. Qty.	Std. Ctn. Qty.
	In.	mm	In.	mm	In.	mm	In.	mm	In.	mm				
<b>R100X150V1C</b>	1.00	25.4	1.50	38.1	0.50	12.7	0.22	5.6	0.28	7.1	Cat. 5e UTP/ Cat. 6 UTP/ Cat. 6A UTP/ Cat. 5e FTP/ 10 – 6 AWG	100	1	10
<b>R100X225V1C</b>			2.25	57.2	0.75	19.1	0.28	7.1	0.39	9.9	Cat. 6 FTP/ Cat. 6 UTP/ Cat. 6A FTP/ 8 – 4 AWG			

### P1™ Self-Laminating Label Cassettes for PanTher™ LS8E/LS8EQ Hand-Held Thermal Transfer Printer

- P1 Label Cassette contains an integrated memory device for automatic formatting, recall of last legend used, and number of labels remaining in the cassette
- Fast loading label cassette includes both label material and ribbon to make changing labels easy
- Self-laminating adhesive labels for wire/cable identification include a colored print-on area and clear overlaminate
- Labels are available in a large range of wire/cable sizes
- Print-On Area Color: Black on White



-50°F to 225°F (-45.6°C to 107°C)

Part Number	Width		Length		Print-On Area Height		Min Cable O.D.		Max Cable O.D.		Wire Range	Labels Per Cassette	Std. Pkg. Qty.	Std. Ctn. Qty.
	In.	mm	In.	mm	In.	mm	In.	mm	In.	mm				
<a href="#">S050X075VAC</a>	0.50	12.7	0.75	19.1	0.25	6.4	0.08	2.0	0.16	4.1	Cat. 6 28 AWG/18 – 14 AWG	450	1	10
<a href="#">S050X125VAC</a>			1.25	31.8	0.38	9.7	0.12	3.1	0.28	7.0	Cat. 3 UTP/12 – 10 AWG	225		
<a href="#">S050X150VAC</a>			1.50	38.1	0.50	12.7	0.16	4.1	0.32	8.1	Cat. 5e UTP/Cat. 6 UTP/ Cat. 6A UTP/Cat. 5e FTP/ 10 – 6 AWG	200		
<a href="#">S075X150VAC</a>	0.75	19.1									Cat. 5e UTP/Cat. 6 UTP/ Cat. 6A UTP/Cat. 5e FTP/ 10 – 6 AWG			
<a href="#">S100X075VAC</a>	1.00	25.4	0.75	19.1	0.25	6.4	0.08	2.0	0.16	4.1	Cat. 6 28 AWG/18 – 14 AWG	350		
<a href="#">S100X125VAC</a>			1.25	31.8	0.38	9.7	0.12	3.1	0.28	7.1	Cat. 3 UTP/12 – 10 AWG	225		
<a href="#">S100X150VAC</a>			1.50	38.1	0.50	12.7	0.16	4.1	0.32	8.1	Cat. 5e UTP/Cat. 6 UTP/ Cat. 6A UTP/Cat. 5e FTP/ 10 – 6 AWG	200		
<a href="#">S100X225VAC</a>			2.25	57.2	0.75	19.1	0.24	6.1	0.48	12.2	Cat. 6 FTP/Cat. 6A UTP/ Cat. 6A FTP/8 – 4 AWG	125		
<a href="#">S100X400VAC</a>			4.00	101.6	1.00	25.4	0.32	8.1	0.95	24.3	2 – 1 AWG	75		

### P1™ Marker Plate Label Cassette for PanTher™ LS8E/LS8EQ Hand-Held Thermal Transfer Printers

- Fast loading P1 Label Cassette includes both label material and ribbon to make changing labels easy
- Marker plates are designed for use on larger diameter wire/cables and may be applied after all terminations are complete
- Meets requirements for MIL-STD-202G, Method 215K, Solutions A, C and D



-58°F to 221°F (-50°C to 105°C)

Part Number	Color	Width		Length		Print-On Area Width		Recommended Cable Tie		Labels Per Cassette	Std. Pkg. Qty.	Std. Ctn. Qty.
		In.	mm	In.	mm	In.	mm	Vertical	Horizontal			
<a href="#">M300X050Y6C</a>	Yellow	3.00	76.2	0.50	12.7	1.80	45.7	<a href="#">PLT2.5I-C</a>	<a href="#">PLT2.5I-C</a>	50	1	10

Order number of cassettes required

### P1™ Flag Label Cassette for PanTher™ LS8E/LS8EQ Hand-Held Thermal Transfer Printers

- Fast loading P1 Label Cassette includes both label material and ribbon to make changing labels easy
- Provides larger labeling area for small cables
- Innovative design allows flag labels to be applied in either adhesive or non-adhesive orientations

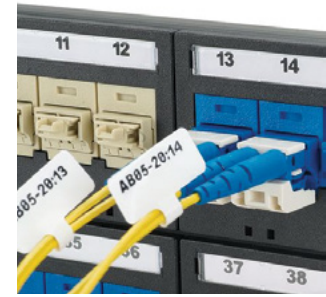

 -40°F to 302°F (-40°C to 150°C)

Part Number	Width		Length		Min. Cable O.D.		Max. Wire O.D.		Labels Per Cassette	Std. Pkg. Qty.	Std. Ctn. Qty.
	In.	mm	In.	mm	In.	mm	In.	mm			
<b>F100X150AJC</b>	1.00	25.4	1.50	38.1	0.12	3.1	0.20	5.1	200	1	10

Order number of cassettes required.

### P1™ Military Grade Die Cut and Continuous Heat Shrink Label Cassettes for PanTher™ LS8E/LS8EQ Thermal Transfer Printers

- P1 Label Cassette contains an integrated memory device for automatic formatting, recall of last legend used, and number of labels remaining in the cassette
- Fast loading label cassette includes both label material and ribbon to make changing labels easy
- Meets print performance requirements of MIL-STD-883F Method 2015.13, Solutions A, B and D, and MIL-STD-202G Method 215K, Solutions A, C and D
- Meets UL Standard 224 for flammability
- Shrink ratio 3:1
- Each cassette contains a roll of non-adhesive flattened polyolefin



 -67°F to 275°F (-55°C to 135°C)

#### Military Grade Die-Cut Heat Shrink Label Cassettes

Part Number	Color	Diameter		Width		Length		Min Cable O.D.		Max Cable O.D.		Wire Range	Std. Pkg. Qty.	Std. Ctn. Qty.
		In.	mm	In.	mm	In.	mm	In.	mm	In.	mm			
<b>H100X025H1C</b>	White	0.13	3.1	0.25	6.4	1.00	25.4	0.04	1.0	0.13	3.3	22 – 18 AWG	1	10
<b>H100X034H1C</b>		0.19	4.7	0.34	8.6			0.06	1.5	0.19	4.8	18 – 12 AWG		
<b>H100X044H1C</b>		0.25	6.3	0.44	11.2			0.08	2.0	0.25	6.4	16 – 10 AWG		
<b>H100X064H1C</b>		0.38	9.7	0.64	16.3			0.13	3.3	0.38	9.7	12 – 6 AWG		

#### Military Grade Continuous Heat Shrink Tape Cassettes

Part Number	Color	Diameter		Width		Length		Min Cable O.D.		Max Cable O.D.		Wire Range	Std. Pkg. Qty.	Std. Ctn. Qty.
		In.	mm	In.	mm	Ft.	m	In.	mm	In.	mm			
<b>H000X025H1C</b>	White	0.13	3.1	0.25	6.4	8.0	2.4	0.04	1.0	0.13	3.3	22 – 18 AWG	1	10
<b>H000X034H1C</b>		0.19	4.7	0.34	8.6			0.06	1.5	0.19	4.8	18 – 12 AWG		
<b>H000X034H2C</b>	Yellow	0.19	4.7	0.34	8.6	6.0	1.8	0.06	1.5	0.19	4.8	18 – 12 AWG		
<b>H000X044H1C</b>	White	0.25	6.3	0.44	11.2			0.08	2.0	0.25	6.4	16 – 10 AWG		
<b>H000X064H1C</b>		0.38	9.7	0.64	16.3			0.13	3.3	0.38	9.7	12 – 6 AWG		
<b>H000X084H1C</b>		0.50	12.7	0.84	21.3			0.17	4.3	0.50	12.7	8 – 1 AWG		

### TDP43ME Thermal Transfer Desktop Printers

- Compact, lightweight design enables use in office or remote locations
- 300 dpi thermal transfer printer creates crisp, clear legends with superior legibility
- Up to 4 inches per second print speed for fast label production
- Use to print a wide variety of self-laminating labels, component labels, non-laminated labels, heat shrink labels, marker plates and continuous tapes up to 4 inches wide
- Panduit® Easy-Mark Plus™ Labeling Software and hybrid ribbon included with printer
- UL 60950 listed, File # E165747



Part Number	Description	Std. Pkg. Qty.
<b>BEST SELLER</b> TDP43ME	300 dpi printer; includes printer, Panduit® Easy-Mark Plus™ Labeling Software, RMEH4BL black hybrid ribbon, AC power adapter with US power cord, USB cable, user manual, quick start card, and driver disk; for use in North America	1
<b>BEST SELLER</b> TDP43ME-KIT	TDP43ME printer kit. Includes: printer, Panduit® Easy-Mark Plus™ Labeling Software, RMEH4BL black hybrid ribbon, AC power adapter with US power cord, USB cable, user manual, quick start card, TDP43ME-RS Roll Stand, TDP43ME-CASE, one roll of S100X150VATY labels, and driver disk; for use in North America	

Accessories available

### Ribbons for Use with the TDP43ME Thermal Transfer Desktop Printer

- **Hybrid** – Recommended for use with self-laminating, heat shrink, component and non-laminated labels
- **Resin** – Recommended for use with polyester labels, continuous vinyl tape, marker plates and raised panel labels



Part Number	Description	Width		Length		Std. Pkg. Qty.
		In.	mm	Ft.	m	
<b>BEST SELLER</b> RMEH4BL*	Black hybrid thermal transfer ribbon. Use with heat shrink, self-laminating, Turn-Tell®, and vinyl cloth labels	4.25	108.0	300.0	91.4	1
RMER4BL*^A	Black resin thermal transfer ribbon. Use with polyester labels, continuous vinyl tape, marker plates, and raised panel labels					

Order number of ribbons required in multiples of Standard Package Quantity.

\*For 2.5 inches wide ribbons, replace 4 in part number with 2. For example, the part number of a 2.5 inches wide black hybrid thermal transfer ribbon is RMEH2BL.

^Other colors available, change "BL" to: BU for Blue, RD for Red, or WH for White (Example: RMER4BU = Blue Resin Ribbon).

### TDP43HET and TDP46HET Thermal Transfer Desktop Printers

- Convenient, easy setup; quickly begin producing labels
- Durable, clear communication through superior legibility
- Print small, fine characters and high-quality images and bar codes
- Allow continuous use in construction, industrial, and harsh environments
- Reduce time required to switch between label styles
- Fast label production without sacrificing print quality
- Panduit® Easy-Mark Plus™ Labeling Software and hybrid ribbon included with printer
- Up to 12 inches per second print speed
- Connect quickly and easily to PC, and offers connectivity flexibility to print by USB, parallel, Ethernet, and serial
- UL 60950 listed, File # E165747

Part Number	Description	Std. Pkg. Qty.
TDP43HET	The TDP43HET Desktop Printer for North American usage has 300 dpi printer and includes Easy-Mark™ Plus Labeling Software, and RMEH4BL black hybrid ribbon, a USB cable, user manual, quick start card, driver disk, and a US power cord	1
TDP46HET	The TDP46HET Desktop Printer for North American usage has 600 dpi printer and includes Easy-Mark™ Plus Labeling Software, RMEH4BL black hybrid ribbon, a USB cable, user manual, quick start card, driver disk, and a US power cord	





### Ribbons for use with the TDP43HET and TDP46HET Thermal Transfer Desktop Printers

- **Hybrid** – Recommended for use with heat shrink, self-laminating, Turn-Tell® Labels, and vinyl cloth
- **Resin** – Recommended for use with polyester labels, continuous vinyl tapes, marker plates and raised panel labels



Part Number	Description	Width		Length		Std. Pkg. Qty.
		In.	mm	Ft.	m	
<b>RHEH4BL</b>	Black hybrid thermal transfer ribbon. Use with heat shrink, self-laminating, Turn-Tell® Labels, and vinyl cloth and tan polyimides labels	4.33	110.0	1181.0	363.0	1
<b>RHER4BL</b>	Black resin thermal transfer ribbon. Use with polyester labels, continuous vinyl tape, marker plates, and raised panel labels					

### Thermal Transfer Turn-Tell® Labels **PATENTED**

- Innovative label design allows labels to rotate for visibility from any angle, and for repositioning on the wire/cable to align legends and improve aesthetics
- Labels can be easily installed on existing terminated wires and assemblies without disconnecting the wires/cables
- Use thermal transfer hybrid ribbon

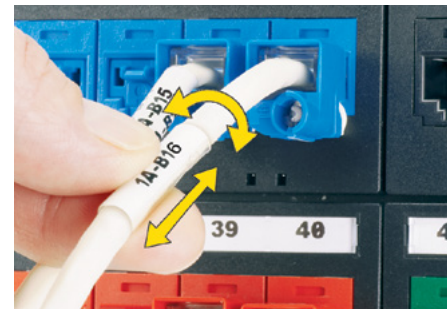

-40°F to 150°F (-40°C to 65.6°C)

Part Number	Print-On Area Color	Width		Length		Print-On Area Height		Min Cable O.D.		Max Cable O.D.		Wire Range	Labels Per Row	Labels Per Pkg.
		In.	mm	In.	mm	In.	mm	In.	mm	In.	mm			
<b>BEST SELLER</b> <b>R100X150V1T</b>	White	1.00	25.4	1.50	38.1	0.50	12.7	0.22	5.6	0.28	7.1	Cat. 5e UTP/ Cat. 6 UTP/ Cat. 6A UTP	4	2500
<b>R100X225V1T</b>				2.25	57.2	0.75	19.1					Cat. 6 FTP/ Cat. 6 UTP/ Cat. 6A FTP		
<b>R150X150V1T</b>		1.50	38.1	1.5	38.1	0.5	12.7	0.28	7.1	0.39	9.9	Cat. 5e UTP/Cat. 6 UTP/ Cat. 6A UTP/ Cat. 5e FTP	1000	
<b>R200X225V1T</b>		2.0	50.8	2.25	57.2	0.75	19.1	0.22	5.6	0.28	7.1	Cat. 6 FTP/ Cat. 6A UTP/ Cat. 6A FTP		

Labels are roll mounted on 3.00 inches cores; when using the **TDP43ME** printer and 3.00 inches cores, the roll stand (**TDP43ME-RS**) is required

### Thermal Transfer Self-Laminating Labels

- Includes a colored print-on area and clear over-laminate to protect the legend for clear and durable identification
- Sized specifically for wire and cable applications
- Thin and conformable; preferred material for most general wire/cable labeling
- Use thermal transfer hybrid ribbon
- Not recommended for flag applications

 -40°F to 150°F (-40°C to 66°C)



Part Number	Print-On Area Color	Width		Length		Print-On Area Height		Min. Cable O.D.		Max Cable O.D.		Wire Range	Labels Per Row	Std. Pkg. Qty.													
		In.	mm	In.	mm	In.	mm	In.	mm	In.	mm																
S050X075VA1Y	White	0.5	12.7	0.75	19.1	0.25	6.4	0.08	2.0	0.16	4.1	Cat. 6 28 AWG/ 18 – 14 AWG	8	5000													
S050X075VATY*														2500													
S050X125VA1Y				1.25	31.8	0.38	9.7	0.12	3.1	0.28	7.0	Cat. 3 UTP/ 12 - 10 AWG	5000														
S050X125VATY*														5													
S050X150VA1Y				1.50	38.1	0.5	12.7	0.16	4.1	0.32	8.1	Cat. 5e UTP/ Cat. 6 UTP/ Cat. 6A UTP/ Cat. 5e FTP/ 10 – 6 AWG	2500														
S050X150VATY*														5000													
S075X125VATY*														5													
S075X150VATY*				0.75	19.1	1.25	31.8	0.38	9.7	0.12	3.1	0.28	7.0	Cat. 3 UTP/12 - 10 AWG	5	5000											
S075X150VATY*																	5										
S100X125VATY*				TIA Blue	1.00	25.4	1.25	31.8	0.38	9.7	0.12	3.1	0.28	7.0	Cat. 3 UTP/ 12 – 10 AWG	4	2500										
S100X150VA1Y	5000																										
S100X150VATY*	1.50	38.1	0.50				12.7	0.16	4.1	0.32	8.1	Cat. 5e UTP/ Cat. 6 UTP/ Cat. 6A UTP/ Cat. 5e FTP/ 10 – 6 AWG	1500														
S100X150VBTY*														5000													
S100X225VA1Y	1.00	25.4	2.25				57.2	0.75	19.1	0.24	6.1	0.48	12.1	Cat. 6 FTP/ Cat. 6A UTP/ Cat. 6A FTP/ 8 – 4 AWG	4	1500											
S100X225VATY*																5000											
S100X250VATY*																2.50	63.5	1.00	25.4	0.32	8.1	0.95	24.3	2 – 1 AWG	1000		
S100X400VA1Y																										2500	
S100X400VATY*																4.00	101.6	6.50	165.1	1.50	38.1	0.48	12.1	1.59	40.4	1/0 – 250 MCM	1000
S100X650VATY*																											
S150X150VATY*	1.50	38.1	1.50	38.1	0.50	12.7	0.16	4.0	0.32	8.1	Cat. 5e UTP/ Cat. 6 UTP/ Cat. 6A UTP/ Cat. 5e FTP/ 10 – 6 AWG	2	5000														
S150X225VATY*														5000													
S150X225VATY*	1.50	38.1	2.25	57.2	0.75	19.1	0.24	6.1	0.48	12.1	Cat. 6 FTP/ Cat. 6A UTP/ Cat. 6A FTP/ 8 – 4 AWG	2	5000														
S150X225VATY*														5000													

- Product Showcase
- Abrasion Protection
- Cable Cleats
- Cable Ties
- Cable Tie Accessories
- Cable Tie Tools
- Identification Products
- Power Connectors
- Grounding Connectors
- Safety Solutions
- Stainless Steel Ties
- Terminals
- Wiring Duct
- Part Number Index

### Thermal Transfer Self-Laminating Labels (continued)

-40°F to 150°F (-40°C to 66°C)

Part Number	Print-On Area Color	Width		Length		Print-On Area Height		Min. Cable O.D.		Max Cable O.D.		Wire Range	Labels Per Row	Std. Pkg. Qty.
		In.	mm	In.	mm	In.	mm	In.	mm	In.	mm			
S150X400VATY*	White	1.50	38.1	4.00	101.6	1.00	25.4	0.32	8.1	0.95	24.1	2 – 1 AWG	2	2500
S200X150VATY*				1.50	38.1	0.50	12.7	0.16	4.0	0.32	8.1	Cat. 5e UTP/ Cat. 6 UTP/ Cat. 6A UTP/ Cat. 5e FTP/ 10 – 6 AWG		5000
S200X225VA1Y														500
S200X225VATY*		2.00	50.8	2.25	57.2	0.75	19.1	0.24	6.1	0.48	12.4	Cat. 6 FTP/ Cat. 6A UTP/ Cat. 6A FTP/ 8 – 4 AWG	1000	
S200X250VATY*				2.50	63.5							12.1	6 – 2 AWG	
S200X400VA1Y						1.00	25.4	0.32	8.1	0.95	24.3	2 – 1 AWG		500
S200X400VATY*				4.00	101.6									
S200X650VA1Y														250
S200X650VATY*				6.50	165.1	1.50	38.1	0.48	12.1	1.59	40.4	1/0 – 250 MCM		1000

Order number of labels required in multiples of Standard Package Quantity

\*Labels are roll mounted on 3.00" cores; when using the TDP43ME printer and 3.00" cores, the roll stand (TDP43ME-RS) is required

### Thermal Transfer, Military Grade, Single-Sided, Heat Shrink Labels

- Permanent, one-piece, heat shrink sleeve designed to provide clear, durable identification of wires and cables
- Meet UL Standard 224 with a VW-1 rating for flammability and AMS-DTL-23053/5C (Class 1 and Class 3)
- Meet SAE-AS81531, MIL-STD-883F Method 2015.13, Solutions A, B, and D, and MIL-STD-202G Method 215K, Solutions A, C, and D when printed with resin and hybrid thermal transfer ribbons
- Shrink ratio 3:1
- Tested for use as an identification marker in (Class 1E) harsh environments
- Use thermal transfer hybrid ribbon or white resin ribbon
- UL224 recognized, File # E205133; CSA certified, C22.2 No. 198.1.06, File # 256205



-67°F to 275°F (-55°C to 135°C)

Part Number (White)	Part Number (Yellow)	Diameter		Width		Height		Min Cable O.D.		Max Cable O.D.		Wire Range	Labels Per Row	Labels Per Roll	Std. Pkg. Qty. (Roll)
		In.	mm	In.	mm	In.	mm	In.	mm	In.	mm				
<b>BEST SELLER</b> H100X025H1*	H100X025H2T	0.13	3.1	1.00	25.4	0.25	6.4	0.04	1.0	0.13	3.3	22 – 18 AWG	2	1000	1
H200X025H1*	H200X025H2T			2.00	50.8								1	500	
<b>BEST SELLER</b> H100X034H1*	H100X034H2T	0.19	4.7	1.00	25.4	0.34	8.6	0.06	1.5	0.19	4.8	18 – 12 AWG	2	1000	
H200X034H1*	H200X034H2T			2.00	50.8								1	500	
<b>BEST SELLER</b> H100X044H1*	H100X044H2T	0.25	6.3	1.00	25.4	0.44	11.2	0.08	2.0	0.25	6.4	16 – 10 AWG	2	1000	
H200X044H1*	H200X044H2T														
<b>BEST SELLER</b> H200X064H1*	H200X064H2T	0.38	9.7	2.00	50.8	0.64	16.3	0.13	3.3	0.38	9.7	12 – 6 AWG	1	500	

\*Available in Bulk packages (5 times Labels Per Roll), add -B to end of part number

### Thermal Transfer Continuous Tape

- Tapes offer crisp, clear legends with superior legibility
- Conformable material for flat applications and safety and facility identification
- Can be over-laminated to increase durability
- Use thermal transfer resin ribbon

# 1B-TGB

 -40°F to 302°F (-40°C to 150°C)

Part Number	Color	Material	Width		Length		Std. Pkg. Qty. (Roll)
			In.	mm	Ft.	m	
T400X000YP1	White	Super-Tack Polyester	4.00	101.6	100.0	30.5	1
T400X000Y81	Yellow						
T400X000YS1	Green						
T400X000YU1	Orange						

Order number of rolls required in multiples of Standard Package Quantity

### Laser/Ink Jet Self-Laminating Labels

- Labels can be printed in both laser and ink jet printers
- Self-laminating adhesive labels include a colored print-on area and clear overlaminates
- Provide durability; high-temperature resistance, and dimensional stability; do not stretch or easily tear; preferred method for wire/cable labeling
- Meets ASTM E-595 for air space handling (white only)
- Not recommended for flag applications

 -65°F to 225°F (-54°C to 107°C)



Part Number	Print-On Area Color	Width		Length		Print-On Area Height		Min. Cable O.D.		Max. Cable O.D.		Wire/Cable Size Range	Labels Per Row	Labels Per Sheet	Labels Per Pkg.
		In.	mm	In.	mm	In.	mm	In.	mm	In.	mm				
S050X075YAJ	White	0.5	12.7	0.75	19.0	0.25	6.4	0.08	2.0	0.16	4.1	18-14 AWG	13	169	5000
S050X125YAJ				1.25	31.8	0.38	9.6	0.12	3.0	0.28	7.1	12-10 AWG		104	
S050X150YAJ				1.5	38.1	0.5	12.7	0.16	4.1	0.32	8.1	10-6 AWG		78	
S075X125YAJ		0.75	19.0	1.25	31.8	0.38	9.6	0.12	3.0	0.28	7.1	12-10 AWG	9	72	
S075X150YAJ				1.5	38.1	0.5	12.7	0.16	4.1	0.32	8.1	10-6 AWG		54	
S100X075YAJ		1.00	25.4	0.75	19.0	0.25	6.4	0.08	2.0	0.16	4.1	18-14 AWG	7	91	
S100X125YAJ				1.25	31.8	0.38	9.7	0.12	3.1	0.28	7.0	Cat. 3 UTP/ 12-10 AWG		56	
S100X150YAJ	1.50			38.1	0.50	12.7	0.16	4.1	0.32	8.1	Cat. 5e UTP/ Cat. 6 UTP/ Cat. 6A UTP /Cat. 5e FTP/10-6 AWG	42			
S100X150YBJ		TIA Blue	Cat. 5e UTP/ Cat. 6 UTP/ Cat. 6A UTP /Cat. 5e FTP/10-6 AWG												
S100X225YAJ	White	2.00	50.8	2.25	57.2	0.75	19.1	0.24	6.1	0.48	12.4	Cat. 6 FTP/ Cat. 6A UTP/Cat. 6A FTP/8-4 AWG	8	32	
S100X400YAJ				4.00	101.6	1.00	25.4	0.32	8.1	0.95	24.3	2-1 AWG		7	14
S100X650YAJ				6.50	165.1	1.50	38.1	0.48	12.1	1.59	40.4	1/0-350 MCM			7
S200X150YAJ		2.00	50.8	1.50	38.1	0.50	12.7	0.16	4.1	0.32	8.1	Cat. 5e UTP/Cat. 6 UTP/ Cat. 6A UTP /Cat. 5e FTP/10-6 AWG	4	24	
S200X225YAJ				2.25	57.2	0.75	19.1	0.24	6.1	0.48	12.1	Cat. 6 FTP/Cat. 6A UTP/ Cat. 6A FTP/ 8-4 AWG		16	
S200X400YAJ				4.00	101.6	1.00	25.4	0.32	8.1	0.95	24.3	2-1 AWG		8	
S200X650YAJ				6.50	165.1	1.50	38.1	0.48	12.1	1.59	40.4	1/0-350 MCM		4	500

### Stainless Steel Marker Plates

- Provides permanent identification of pipes, conduit, valves, cables, and equipment in harsh environments
- Designed for use with Panduit® Pan-Steel® Stainless Steel Cable Ties for fast installation at lowest installed cost
- Designated plates feature easy feed design with a raised slot to simplify cable tie installation and improve productivity



TEMPERATURE RANGE: -112°F to 1000°F (-80°C to 538°C)

Part Number	Material	Length/ Diameter		Width/ Diameter		Thickness		Used with Pan-Steel Cable Ties**	For Use With			Std. Pkg. Qty.^	Std. Ctn. Qty.
		In.	mm	In.	mm	In.	mm		MIM	PES197	PES400		
<b>BEST SELLER</b> MMP350-M316	316 Stainless Steel	3.50	89.0	0.75	19.0	0.010	0.25	MLT-S	✓	✓	✓	1000	4000
MMP350-M	304 Stainless Steel												
MMP350H-MAL	Aluminum												
MMP350W38-M316	316 Stainless Steel			0.38	9.7			MLT-S					

^Order number of pieces required, in multiples of Standard Package Quantity

### PES400 Embossing System

- Permanent identification solution on-site and on-demand
- Creates raised characters on stainless steel and aluminum marker plates for maximum visibility for medium to high volume applications exposed to dirt and paint
- Fast speed up to 300 plates per hour
- Includes 3 mm and 5 mm characters
- Includes Easy-Mark™ Plus Labeling Software



Part Number	Description	Std. Pkg. Qty.
PES400	Panduit embossing system, 0.188" (5mm) and 0.118" (3mm) characters, 35.8" x 23.6" x 16.5", 154lb. (75kg), 100 to 240 VAC, 50/60Hz	1

Characters include: ABCD...Z, 0123...9, @ # % & \* ( ) - + : , . / ' "

### Embossing Tool and Tapes



Part Number	For Use With	Description	Lettering Height	
			In.	mm
<b>Metal Embossing Hand Tool</b>				
MEHT187	META-X, METS3-X, METS4-X	Includes (1) Tool, (1) additional marking wheel, (1) carrying case, (1) roll each META (aluminum) and METS (stainless steel) tape.	0.1875	4.76

Part Number	Color	Material	Overall Width		Overall Length		Overall Thickness	
			In.	mm	In.	mm	In.	mm
<b>Indoor/Outdoor Embossing Tape</b>								
METS3-X	Silver	316 Stainless Steel	0.5	12.7	252	6401	0.01	0.1
METS4-X		304 Stainless Steel						



# POWER CONNECTORS

---

Code Conductor-One Hole.....	110-112
Code Conductor-Two Hole.....	113
Code Conductor-Two Hole, Long Barrel Lug.....	114-115
Code Conductor-Standard Barrel, Butt Splice.....	116
Flex Conductor-One Hole.....	117
Flex Conductor-Two Hole.....	118
Flex Conductor-Two Hole, Long Barrel Window Lug.....	119
Code Conductor-Two Hole, Aluminum Lug.....	120
Split Bolt-Copper.....	121
One-Hole Straight Tongue, Barrel Post Lug.....	121
One-Hole, Single Piece, Straight Fixed Tongue Lug.....	122
One-Hole Single Barrel Lug.....	123
One-Hole Two Barrel Lug.....	123
In-Line Splicer/Reducer with Clear Insulation.....	124
Multi-Tap Connector with Clear Insulation, Single-Sided.....	124
Multi-Tap Connector with Clear Insulation, Single-Sided-Tools.....	125
Portable Manual Contour Crimp™ Controlled Cycle Tools.....	125
Portable Manual, Crimping Tools.....	125-128



### Code Conductor, One-Hole, Standard Barrel with Window Lugs

For Use with Stranded Copper Conductors

#### Type LCA

- Color-coded barrels marked with Panduit and specified competitor die index numbers for proper crimp die selection
- An inspection window aids to visually assure full conductor insertion, and the tin-plated material helps to inhibit corrosion
- UL Listed and CSA certified to 35kV\*\* and temperature rated to 90°C when crimped with Panduit and specified competitor crimping tools and dies
- Tested by Telcordia – meets NEBS Level 3
- American Bureau of Shipping Approved

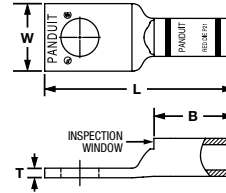

Part Number	Copper Conductor Size	Stud Hole Size In.	Figure Dimensions In.				Panduit Color Code	Panduit Die Index No.‡	Burdny Die Index No.‡	T&B Die Index No.‡	Wire Strip Length In.	Std. Pkg. Qty.					
			W	B	T	L											
LCA10-10-L*	#14 – #10 AWG STR	#10	0.38	0.38	0.06	1.07	—	—	—	—	0.4375						
LCA8-10-L			0.41		0.08	1.25											
<b>BEST SELLER</b> LCA8-14-L	#8 AWG	0.25	0.48	0.56	0.07	1.34	Red	P21	49	21	0.625						
LCA8-38-L		0.375	0.60		0.05	1.56											
LCA6-10-L	#6 AWG	#10	0.45	0.81	0.09	1.52	Blue	P24	7	24	0.875	50					
<b>BEST SELLER</b> LCA6-14-L		0.25	0.48		0.08	1.61											
LCA6-38-L		0.375	0.62		0.06	1.83											
<b>BEST SELLER</b> LCA4-14-L	#4 – #3 AWG STR, #2 AWG SOL	0.25	0.55	0.09	1.63	Gray	P29	8	29								
LCA4-56-L		0.3125		0.09	1.75												
LCA4-38-L		0.375	0.62	0.07	1.85												
<b>BEST SELLER</b> LCA2-14-Q	#2 AWG	0.25	0.60	0.88	1.77	Brown	P33	10	33		0.9375	25					
<b>BEST SELLER</b> LCA2-56-Q		0.3125	0.66		1.90												
LCA2-38-Q		0.375	0.75		1.97												
LCA2-12-Q		0.5	0.75	0.08	2.21												
LCA1-14-E	#1 AWG	0.25	0.70	0.11	1.79	Green	P37	11	37			20					
LCA1-38-E		0.375			1.99												
<b>BEST SELLER</b> LCA1/0-14-X	1/0 AWG	0.25	0.76	0.94	0.12	2.00	Pink	P42	12	42	1						
<b>BEST SELLER</b> LCA1/0-56-X		0.3125											2.08				
<b>BEST SELLER</b> LCA1/0-38-X		0.375											2.09				
<b>BEST SELLER</b> LCA2/0-56-X	2/0 AWG	0.3125	0.85	0.98	0.13	2.15	Black	P45	13	45	1.0625	10					
<b>BEST SELLER</b> LCA2/0-38-X		0.375											2.40				
<b>BEST SELLER</b> LCA2/0-12-X		0.5											2.34				
<b>BEST SELLER</b> LCA3/0-38-X	3/0 AWG	0.375	0.96	1.14	0.14	2.45	Orange	P50	14	50	1.1875						
<b>BEST SELLER</b> LCA4/0-38-X	4/0 AWG	0.375	1.06	1.19	0.14	2.68	Purple	P54	15	54	1.25						
<b>BEST SELLER</b> LCA4/0-12-X		0.5				2.55											
<b>BEST SELLER</b> LCA250-38-X	250 kcmil	0.375	1.17	1.25	0.14	2.78	Yellow	P62	16	62	1.3125						
<b>BEST SELLER</b> LCA250-12-X						2.78											
LCA350-12-X	350 kcmil		1.28	1.44	0.17	3.09	Red	P71	18	71	1.5	6					
LCA400-12-6	400 kcmil	0.5	1.39	1.50	0.18	3.22	Blue	P78	19	76	1.5625						
LCA500-12-6	500 kcmil												0.22	3.55	Brown	P87	20
LCA600-12-6	600 kcmil											1.70	0.26	4.20	Green	P94	22

‡Visit [www.panduit.com](http://www.panduit.com) for tool and die information

\*Not tested to NEBS Level 3 requirements

\*\*Consult cable manufacturer for voltage stress relief instructions with applications greater than 2000 V



### Code Conductor, One-Hole, Standard Barrel with Window, Narrow Tongue Lugs

For Use with Stranded Copper Conductors

#### Type LCAF

- Narrow tongue width for limited space applications
- Color-coded barrels marked with Panduit and specified competitor die index numbers for proper crimp die selection
- Inspection window to visually assure full conductor insertion
- Tin-plated to inhibit corrosion
- UL Listed and CSA Certified to 35 KV\*\* and temperature rated to 90°C when crimped with Panduit and specified competitor crimping tools and dies
- UL Listed and CSA Certified for wide wire range-taking capability when crimped with Panduit® Uni-Die™ Dieless Crimping Tools‡

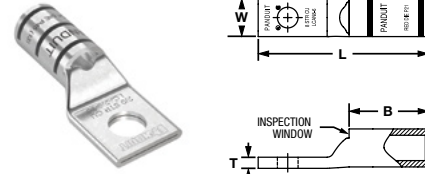

Part Number	Copper Conductor Size	Stud Hole Size In.	Figure Dimensions In.				Panduit Color Code	Panduit Die Index No.‡	Burndy Die Index No.‡	T&B Die Index No.‡	Wire Strip Length In.	Std. Pkg. Qty.
			W	B	T	L						
LCAN2/0-38-X	2/0 AWG	0.375	0.58	0.98	0.13	2.15	Black	P45	13	45	1.0625	10
LCAN250-38-X	350 kcmil		0.77	1.25	0.15	2.55	Yellow	P62	16	62	1.3125	
LCAN3/0-56-X	3/0 AWG	0.3125	0.64	1.14	0.13	2.28	Orange	P50	14	50	1.1875	
LCAN350-38-X	350 kcmil	0.375	0.88	1.44	0.17	2.98	Red	P71	18	71	1.5	
LCAN4/0-38-X	4/0 AWG		0.71	1.19	0.15	2.45	Purple	P54	15	54	1.25	



### Flex Conductor, One-Hole, Standard Barrel with Window, Flared NEBS Lugs

For Use with Flexible and Extra-Flexible Copper Conductors

#### Type LCAF

- Can be used with flex conductor class: K, M, and Diesel Locomotive
- Flared entry prevents bent back strands when inserting find strand conductor into barrel
- Color-coded barrels marked with Panduit die index numbers for proper crimp die selection
- Inspection window to visually assure full conductor insertion
- Tin-plated to inhibit corrosion
- UL Listed and CSA Certified to 35 KV\*\* and temperature rated to 90°C when crimped with Panduit crimping tools and dies
- Tested by Telcordia – meets NEBS Level 3
- American Bureau of Shipping approved

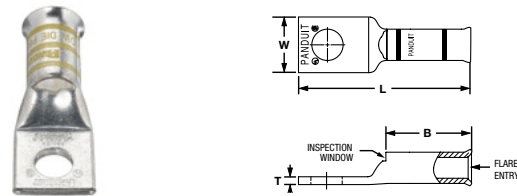

Part Number	Copper Conductor Size	Stud Hole Size In.	Figure Dimensions In.				Panduit Color Code	Panduit Die Index No.‡	Burndy Die Index No.‡	T&B Die Index No.‡	Wire Strip Length In.	Std. Pkg. Qty.
			W	B	T	L						
LCAF4/0-12-X	4/0 AWG	0.5	1.17	1.35	0.14	2.88	Yellow	P62	16	62	1.4375	10

‡Visit [www.panduit.com](http://www.panduit.com) for tool and die information

\*Not tested to NEBS Level 3 requirements

\*\*Consult cable manufacturer for voltage stress relief instructions with applications greater than 2000 V

Product Showcase

Abrasion Protection

Cable Cleats

Cable Ties

Cable Tie Accessories

Cable Tie Tools

Identification Products

Power Connectors

Grounding Connectors

Safety Solutions

Stainless Steel Ties

Terminals

Wiring Duct

Part Number Index



### Code Conductor, One-Hole, Long Barrel Lugs

**For Use with Stranded Copper Conductors**

**Type LCB**

- Long barrel maximizes number of crimps and provides premium wire pull-out strength and electrical performance
- Color-coded barrels marked with Panduit and specified competitor die index numbers for proper crimp die selection
- Enclosed barrel prevents corrosive material from entering barrel when used in harsh environments
- Tin-plated to inhibit corrosion
- UL Listed and CSA Certified to 35 kV\*\* and temperature rated to 90°C when crimped with Panduit and specified competitor crimping tools and dies

- UL Listed and CSA Certified for wide wire range-taking capability when crimped with Panduit® Uni-Die™ Dieless Crimping Tools‡
- Tested by Telcordia – meets NEBS Level 3
- American Bureau of Shipping Approved

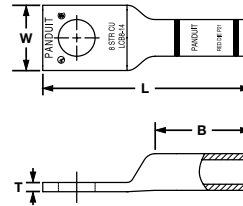

Part Number	Copper Conductor Size	Stud Hole Size In.	Figure Dimensions In.				Panduit Color Code	Panduit Die Index No.‡	Burdny Die Index No.‡	T&B Die Index No.‡	Wire Strip Length In.	Std. Pkg. Qty.
			W	B	T	L						
LCB4/0-12-X	4/0 AWG	0.5	1.06	1.56	0.14	3.22	Purple	P54	15	54	1.625	10

‡Visit [www.panduit.com](http://www.panduit.com) for tool and die information

\*\*Consult cable manufacturer for voltage stress relief instructions with applications greater than 2000 V



**Like what you see and want more?**

Visit [www.panduit.com](http://www.panduit.com) for the full offering of Panduit products



### Code Conductor, Two-Hole, Standard Barrel with Window Lugs

For Use with Stranded Copper Conductors

#### Type LCD

- Color-coded barrels marked with Panduit and specified competitor die index numbers for proper crimp die selection
- The long barrel maximizes the number of crimps and provides premium wire pull-out strength and performance
- An inspection window aids to visually assure full conductor insertion, and the tin-plated material helps to inhibit corrosion
- UL Listed and CSA certified to 35kV\*\* and temperature rated to 90°C when crimped with Panduit and specified competitor crimping tools and dies

- Tested by Telcordia – meets NEBS Level 3
- American Bureau of Shipping approved
- Available with NEMA hole sizes and spacing

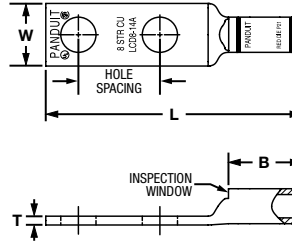

Part Number	Copper Conductor Size	Stud Hole Size In.	Stud Hole Spacing In.	Figure Dimensions In.				Panduit Color Code	Panduit Die Index No.‡	Burdny Die Index No.‡	T&B Die Index No.‡	Wire Strip Length In.	Std. Pkg. Qty.	
				W	B	T	L							
<b>BEST SELLER</b> LCD10-10A-L*	#14 – #10 AWG STR, #12 – #10 AWG SOL	#10	0.63	0.38	0.38	0.06	1.69	—	—	—	—	0.4375	50	
<b>BEST SELLER</b> LCD10-14A-L*				0.42		0.05	1.78	—	—	—				
LCD8-10A-L	#8 AWG	#10	0.63	0.41	0.56	0.08	1.88	Red	P21	49	21	0.625		
LCD8-14A-L				0.48		0.07	1.97							
<b>BEST SELLER</b> LCD6-10A-L	#6 AWG	#10	0.63	0.46	0.81	0.08	2.15	Blue	P24	7	24	0.875		
<b>BEST SELLER</b> LCD6-14A-L				2.24										
<b>BEST SELLER</b> LCD6-14AF-L				0.48			1.66							
<b>BEST SELLER</b> LCD6-14D-L				2.61										
<b>BEST SELLER</b> LCD4-14A-L	#4 – #3 AWG STR, #2 AWG SOL	#10	0.63	0.55	0.09	0.09	2.26	Gray	P29	8	29	0.9375		
<b>BEST SELLER</b> LCD4-14AF-L				1.74										
LCD2-14A-Q	#2 AWG	#10	0.63	0.60	0.88	0.10	2.40	Brown	P33	10	33	0.9375		25

‡Visit [www.panduit.com](http://www.panduit.com) for tool and die information

\*Not tested to NEBS Level 3 requirements

\*\*Consult cable manufacturer for voltage stress relief instructions with applications greater than 2000 V



### Like what you see and want more?

Visit [www.panduit.com](http://www.panduit.com) for the full offering of Panduit products





### Code Conductor, Two-Hole, Long Barrel Lugs

For Use with Stranded Copper Conductors

#### Type LCC

- Color-coded barrels marked with Panduit and specified competitor die index numbers for proper crimp die selection
- The long barrel maximizes the number of crimps and provides premium wire pull-out strength and performance
- The enclosed barrel prevents corrosive material from entering the barrel when used in harsh environments
- Tin-plated to inhibit corrosion
- UL Listed and CSA certified to 35kV\*\* and temperature rated to 90°C when crimped with Panduit and specified competitor crimping tools and dies
- Tested by Telcordia – meets NEBS Level 3
- American Bureau of Shipping approved

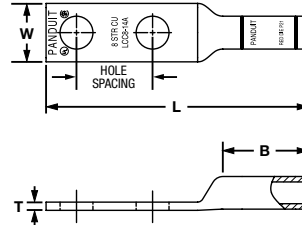

Part Number	Copper Conductor Size	Stud Hole Size In.	Stud Hole Spacing In.	Figure Dimensions In.				Panduit Color Code	Panduit Die Index No.‡	Burndy Die Index No.‡	T&B Die Index No.‡	Wire Strip Length In.	Std. Pkg. Qty.
				W	B	T	L						
<b>BEST SELLER</b> LCC6-14A-L	#6 AWG	0.25	0.63	0.48	1.07	0.08	2.56	Blue	P24	7	24	1.125	50
LCC6-38D-L		0.375	1.00	0.62		0.06	3.15						
LCC2-14A-Q	#2 AWG	0.25	0.63	0.60	1.16	0.10	2.77	Brown	P33	10	33	1.25	25
LCC4/0-12-X ♦	4/0 AWG	0.5	1.75	1.06	1.56	0.14	5.13	Purple	P54	15	54	1.625	10
<b>BEST SELLER</b> LCC350-12-X ♦	350 kcmil			1.28	2.24	0.17	5.99	Red	P71	18	71	2.3125	
LCC400-12-6 ♦	400 kcmil			1.39	2.30	0.18	6.10	Blue	P76	19	76	2.375	
<b>BEST SELLER</b> LCC500-12-6 ♦	500 kcmil			1.54	2.50	0.22	6.36	Brown	P87	20	87	2.5625	6
<b>BEST SELLER</b> LCC600-12-6 ♦	600 kcmil			1.70	2.69	0.26	6.63	Green	P94	22	94	2.75	
<b>BEST SELLER</b> LCC750-12-6 ♦	750 kcmil			1.89	2.87	0.26	7.04	Black	P106	24	106	2.9375	

‡Visit [www.panduit.com](http://www.panduit.com) for tool and die information

\*\*Consult cable manufacturer for voltage stress relief instructions with applications greater than 2000 V

♦NEMA hole sizes and spacing



### Like what you see and want more?

Visit [www.panduit.com](http://www.panduit.com) for the full offering of Panduit products



### Code Conductor, Two-Hole, Long Barrel with Window Lugs

For Use with Stranded Copper Conductors

#### Type LCC-W

- Color-coded barrels marked with Panduit and specified competitor die index numbers for proper crimp die selection
- The long barrel maximizes the number of crimps and provides premium wire pull-out strength and performance
- An inspection window aids to visually assure full conductor insertion, and the tin-plated material helps to inhibit corrosion
- UL Listed and CSA certified to 35kV\*\* and temperature rated to 90°C when crimped with Panduit and specified competitor crimping tools and dies
- Tested by Telcordia – meets NEBS Level 3

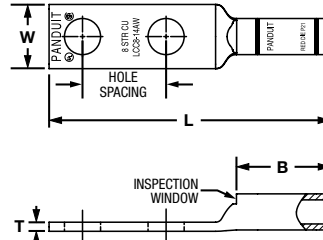

Figure 1



Part Number	Fig. No.	Copper Conductor Size	Stud Hole Size In.	Stud Hole Spacing In.	Figure Dimensions In.				Panduit Color Code	Panduit Die Index No.‡	Burdby Die Index No.‡	T&B Die Index No.‡	Wire Strip Length In.	Std. Pkg. Qty.				
					W	B	T	L										
LCC10-14AW-L*	1	#14 – 10 AWG STR, #12 – 10 AWG SOL	0.25	0.63	0.42	0.53	0.05	1.93	—	—	—	—	0.5625	50				
LCC8-10AW-L		#8 AWG	#10		0.41	0.70			0.08	2.01	Red	P21			49	21	0.75	
LCC6-14AW-L		#6 AWG	0.25	0.48	1.07	2.49	Blue	P24			7	24	1.125					
LCC6-14JAW-L	2	#6 AWG	0.25	0.50 – 0.63	0.48	1.07	0.14	4.95	Purple	P54	15	54	1.625	10				
LCC4/0-12W-X ♦		4/0 AWG	0.5		1.06	1.56			5.03	Yellow	P62	16	62		1.6875			
LCC250-12W-X ♦	1	250 kcmil	0.5	1.75	1.28	2.24	0.17	5.76	Red	P71	18	71	2.3125	6				
LCC350-12W-X ♦		350 kcmil							2.30	5.84	Blue	P76	19		76	2.375		
LCC400-12W-6 ♦		400 kcmil			1.54	2.50	0.22	6.12			Brown	P87	20		87	2.5625		
LCC500-12W-6 ♦		500 kcmil							1.70	2.69	0.26	6.36	Green		P94	22	94	2.75
LCC600-12W-6 ♦		600 kcmil																

‡Visit [www.panduit.com](http://www.panduit.com) for tool and die information

\*Not tested to NEBS level 3 requirements

\*\*Consult cable manufacturer for voltage stress relief instructions with applications greater than 2000 V

♦NEMA hole sizes and spacing



### Like what you see and want more?

Visit [www.panduit.com](http://www.panduit.com) for the full offering of Panduit products



### Code Conductor, Standard Barrel, Butt Splice

For Use with Stranded Copper Conductors

#### Type SCS

- Color-coded barrels marked with Panduit and specified competitor die index numbers for proper crimp die selection
- Internal wire stops to prevent over-insertion of conductor
- Tin-plated to inhibit corrosion
- UL Listed and CSA Certified to 35 kV\*\* and temperature rated to 90°C when crimped with Panduit and specified competitor crimping tools and dies
- UL Listed and CSA Certified for wide wire range-taking capability when crimped with Panduit®

- Uni-Die™ Dieless Crimping Tools‡
- Tested by Telcordia – meets NEBS Level 3
- American Bureau of Shipping approved

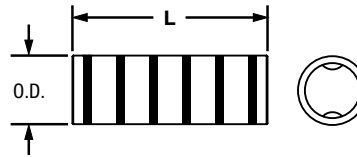

Part Number	Copper Conductor Size	Figure Dimensions In.		Panduit Color Code	Panduit Die Index No.‡	Burndy Die Index No.‡	T&B Die Index No.‡	Wire Strip Length In.	Std. Pkg. Qty.
		Barrel O.D.	L						
<b>SCS6-L</b>	#8 AWG	0.27	1.50	Red	P21	49	21	1.0625	50

‡Visit [www.panduit.com](http://www.panduit.com) for tool and die information

\*\*Consult cable manufacturer for voltage stress relief instructions with applications greater than 2000 V



### Code Conductor, Long Barrel, Butt Splice

For Use with Stranded Copper Conductors

#### Type SCL

- Long barrel maximizes the number of crimps and provides premium wire pull-out strength and electrical performance
- Color-coded barrels marked with Panduit and specified competitor die index numbers for proper crimp die selection
- Internal wire stops to prevent over-insertion of conductor
- Tin-plated to inhibit corrosion
- UL Listed and CSA Certified to 35 kV\*\* and temperature rated to 90°C when crimped with Panduit and specified competitor crimping tools and dies

- UL Listed and CSA Certified for wide wire range-taking capability when crimped with Panduit® Uni-Die™ Dieless Crimping Tools‡
- Tested by Telcordia – meets NEBS Level 3

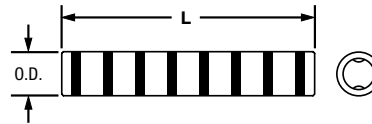

Part Number	Copper Conductor Size	Figure Dimensions In.		Panduit Color Code	Panduit Die Index No.‡	Burndy Die Index No.‡	T&B Die Index No.‡	Wire Strip Length In.	Std. Pkg. Qty.
		Barrel O.D.	L						
<b>SCL6-L</b>	#6 AWG	0.31	2.38	Blue	P24	7	24	1.125	50

‡Visit [www.panduit.com](http://www.panduit.com) for tool and die information

\*\*Consult cable manufacturer for voltage stress relief instructions with applications greater than 2000 V



**Like what you see and want more?**

Visit [www.panduit.com](http://www.panduit.com) for the full offering of Panduit products



### Flex Conductor, One-Hole, Standard Barrel with Window Lugs

For Use with Flexible, Extra-Flexible, and Code Stranded Copper Conductors

#### Type LCAX

- Color-coded barrels marked with Panduit and specified competitor die index numbers for proper crimp die selection
- The generously beveled wire entry prevents bent back strands when inserting the conductor into the barrel
- An inspection window to visually assure full conductor insertion
- Tin-plated to inhibit corrosion
- UL Listed and CSA certified to 35kV\*\* and temperature rated to 90°C when crimped with Panduit and specified competitor crimping tools and dies
- American Bureau of Shipping approved

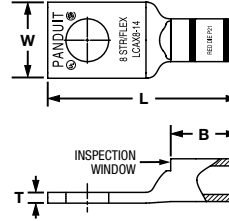

Part Number	Flex Conductor Size		Code Conductor Size	Stud Hole Size In.	Figure Dimensions In.				Panduit Color Code	Panduit Die Index No.‡	Burdmy Die Index No.‡	T&B Die Index No.‡	Wire Strip Length In.	Std. Pkg. Qty.
	Class G, H, I, K, M	Diesel Locomotive			W	B	T	L						
<b>BEST SELLER</b> LCAX6-14-L	#6 AWG	#6 AWG	#6 AWG	0.25	0.48	0.48	0.08	1.28	Blue	P24	7	24	0.5625	50
LCAX4-14-L	#4 AWG	#5, #4, #3 AWG	#4 AWG		0.55	0.53	0.09	1.35	Gray	P29	8	29	0.625	
<b>BEST SELLER</b> LCAX2-14-E*	#2 AWG	#2 AWG	#2 AWG	0.3125	0.70	0.59	0.11	1.50	Brown	P33	10	33	1.0625	20
LCAX2-56-E*				1.63										
LCAX2-38-E*				1.70										
LCAX1/0-14-X	1/0 AWG	1/0 AWG	1/0 AWG	0.25	0.85	0.72	0.13	1.82	Pink	P42	12	42	0.75	10
LCAX1/0-56-X				0.3125				1.89						
<b>BEST SELLER</b> LCAX1/0-38-X				0.375				1.97						
LCAX2/0-56-X	2/0 AWG	2/0 AWG	2/0 AWG	0.3125	0.96	0.83	0.16	2.03	Black	P45	13	45	0.875	10
<b>BEST SELLER</b> LCAX2/0-38-X				0.375				2.17						
<b>BEST SELLER</b> LCAX3/0-38-X	3/0 AWG	3/0 AWG	3/0 AWG	0.375	1.06	0.91	0.14	2.17	Orange	P50	14	50	1	10
LCAX4/0-14-X	4/0 AWG	4/0 AWG	4/0 AWG	0.25	1.19	1.03	0.16	2.30	Purple	P54	15	54	1.0625	
LCAX4/0-56-X				0.3125				2.53						
<b>BEST SELLER</b> LCAX4/0-38-X				0.375				2.53						
<b>BEST SELLER</b> LCAX4/0-12-X				0.5				2.64						
<b>BEST SELLER</b> LCAX250-38-X	250 kcmil	262.6 kcmil	—	0.375	1.28	0.17	0.17	2.57	Yellow	P62	16	62	1.0625	10
<b>BEST SELLER</b> LCAX250-12-X				0.5				2.68						
LCAX350-38-6	350 kcmil	373.7 kcmil	—	0.375	1.54	1.29	0.22	2.93	Blue	P76	19	76H	1.375	6
<b>BEST SELLER</b> LCAX350-12-6								3.09						
LCAX450-12-6								1.70						
LCAX500-12-6	500 kcmil	535.3 kcmil	—	0.5	1.89	1.48	0.26	3.64	Pink	P99	L99	99H	1.5625	
<b>BEST SELLER</b> LCAX750-12-3	—	777.7 kcmil	—	—	2.17	1.66	0.32	3.94	Yellow	P115	L115	115H	1.75	3

‡Visit [www.panduit.com](http://www.panduit.com) for tool and die information

\*Not UL Listed or CSA Certified with Class K flex conductor when crimped with Burndy tools

\*\*Consult cable manufacturer for voltage stress relief instructions with applications greater than 2000 V

- Product Showcase
- Abrasion Protection
- Cable Cleats
- Cable Ties
- Cable Tie Accessories
- Cable Tie Tools
- Identification Products
- Power Connectors
- Grounding Connectors
- Safety Solutions
- Stainless Steel Ties
- Terminals
- Wiring Duct
- Part Number Index



### Flex Conductor, Two-Hole, Standard Barrel with Window Lugs

For Use with Flexible, Extra-Flexible, and Code Stranded Copper Conductors

#### Type LCDX

- Can be used with code conductor and flex conductor class: G, H, I, K, M and Diesel Locomotive
- Generously beveled wire entry prevents bent back strands when inserting conductor into barrel
- Color-coded barrels marked with Panduit and specified competitor die index numbers for proper crimp die selection
- Inspection window to visually assure full conductor insertion
- Tin-plated to inhibit corrosion
- UL Listed and CSA Certified to 35 KV\*\* and temperature rated to 90°C when crimped with Panduit and specified competitor crimping tools and dies
- American Bureau of Shipping approved
- Available with NEMA hole sizes and spacing

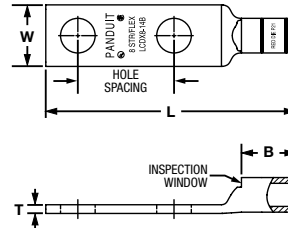

Part Number	Flex Conductor Size		Code Conductor Size	Stud Hole Size In.	Stud Hole Spacing In.	Figure Dimensions In.				Panduit Color Code	Panduit Die Index No.‡	Burndy Die Index No.‡	T&B Die Index No.‡	Wire Strip Length In.	Std. Pkg. Qty.
	Class G, H, I, K, M	Diesel Locomotive				W	B	T	L						
<b>BEST SELLER</b> LCDX8-14A-L	#8 AWG	#8 AWG	#8 AWG	0.25	0.63	0.48	0.42	0.07	1.83	Blue	P24	7	24	1.125	50
LCDX6-14A-L	#6 AWG	#6 AWG	#6 AWG				0.48	0.08	1.91					0.5625	
LCDX2-14A-E*	#2 AWG	#2 AWG	#2 AWG			0.70	0.59	0.11	2.13	Brown	P33	10	33	0.6875	20
<b>BEST SELLER</b> LCDX4/0-14A-X	4/0 AWG	4/0 AWG	4/0 AWG			1.19	1.03	0.16	2.74	Purple	P54	15	54	1.0625	10
LCDX4-14A-L	#4 AWG	#5, #4, #3 AWG	#4 AWG			0.55	0.55	0.53	0.09	Gray	P29	8	29	0.625	50

‡Visit [www.panduit.com](http://www.panduit.com) for tool and die information

\*Not UL Listed or CSA Certified with Class K flex conductor when crimped with Burndy tools

\*\*Consult cable manufacturer for voltage stress relief instructions with applications greater than 2000 V

◆ NEMA hole sizes and spacing



### Like what you see and want more?

Visit [www.panduit.com](http://www.panduit.com) for the full offering of Panduit products





## Flex Conductor, Two-Hole, Long Barrel with Window Lugs

For Use with Flexible, Extra-Flexible, and Code Stranded Copper Conductors

### Type LCCX

- Color-coded barrels marked with Panduit and specified competitor die index numbers for proper crimp die selection
- The long barrel maximizes the number of crimps and provides premium wire pull-out strength and performance
- The generously beveled wire entry prevents bent back strands when inserting the conductor into the barrel
- Tin-plated to inhibit corrosion
- UL Listed and CSA certified to 35kV\*\* and temperature rated to 90°C when crimped with Panduit and specified competitor crimping tools and dies
- Available with NEMA hole sizes and spacing
- An inspection window to visually assure full conductor insertion

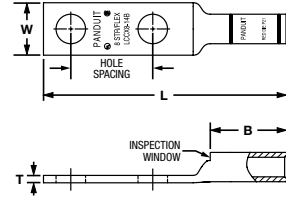

Part Number	Flex Conductor Size			Stud Hole Size In.	Stud Hole Spacing In.	Figure Dimensions In.				Panduit Color Code	Panduit Die Index No.‡	Burdny Die Index No.‡	T&B Die Index No.‡	Wire Strip Length In.	Std. Pkg. Qty.
	Class G, H, I, K, M	Diesel Locomotive	Code Conductor Size			W	B	T	L						
<b>BEST SELLER</b> LCCX6-14A-L	#6 AWG	#6 AWG	#6 AWG	0.25	0.63	0.48	1.07	0.08	2.49	Blue	P24	7	24	1.125	50
LCCX4-14A-L	#4 AWG	#5, #4, #3 AWG	#4 AWG			0.55	1.05	0.09	2.49	Gray	P29	8	29		
<b>BEST SELLER</b> LCCX2-14A-E*	#2 AWG	#2 AWG	#2 AWG			0.70	1.36	0.11	2.89	Brown	P33	10	33	1.4375	20
<b>BEST SELLER</b> LCCX2/0-38D-X	2/0 AWG	2/0 AWG	2/0 AWG	0.375	1.00	0.96	1.50	0.13	3.70	Black	P45	13	45	1.5625	10
<b>BEST SELLER</b> LCCX4/0-38D-X	4/0 AWG	4/0 AWG	4/0 AWG			1.19	2.24	0.16	4.55	Purple	P54	15	54		
LCCX4/0-12-X ◆									5.73						
<b>BEST SELLER</b> LCCX300-12-6	300 kcmil	313.1 kcmil	—	0.5	1.75	1.39	2.30	0.18	5.85	Red	P71	18	71H	2.375	6
<b>BEST SELLER</b> LCCX350-12-6 ◆	350 kcmil	373.7 kcmil	—			1.54	2.50	0.22	6.13	Blue	P76	19	76H	2.5625	
<b>BEST SELLER</b> LCCX450-12-6 ◆	450 kcmil	444.4 kcmil	—			1.70	2.69	0.26	6.37	Brown	P87	20	87	2.75	
<b>BEST SELLER</b> LCCX500-12-6 ◆	500 kcmil	535.3 kcmil	—			1.89	2.88	0.26	6.66	Pink	P99	L99	99H	2.9375	
<b>BEST SELLER</b> LCCX650-12-6 ◆	—	646.4 kcmil	—			1.95	2.94	0.30	6.75	Black	P106	24	106H	3.00	

‡Visit [www.panduit.com](http://www.panduit.com) for tool and die information

\*Not UL Listed or CSA Certified with Class K flex conductor when crimped with Burdny tools

\*\*Consult cable manufacturer for voltage stress relief instructions with applications greater than 2000 V

◆NEMA hole sizes and spacing

Product Showcase

Abrasion Protection

Cable Cleats

Cable Ties

Cable Tie Accessories

Cable Tie Tools

Identification Products

Power Connectors

Grounding Connectors

Safety Solutions

Stainless Steel Ties

Terminals

Wiring Duct

Part Number Index



### Code Conductor, Two-Hole, Aluminum Lugs

For Use with Stranded Aluminum or Copper Code Conductors

#### Type LAB

- Manufactured from high conductivity thick wall wrought aluminum
- Factory pre-filled with joint compound and sealed with easy pull-out end plug to inhibit corrosion
- Color-coded barrel markings and Panduit and specified competitor die index numbers marked on barrel for proper crimp die selection
- Enclosed barrel prevents corrosive material from entering barrel when used in harsh environments
- Tin-plated to inhibit corrosion
- cULus listed to 35 kV\*\* and temperature rated to 90°C when crimped with Panduit and specified competitor crimping tools and dies
- Available with NEMA hole sizes and spacing

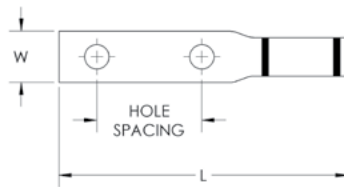

Part Number	Aluminum or Copper Conductor Size	Stud Hole Size In.	Stud Hole Spacing In.	Figure Dimensions In.				Panduit Color Code	Panduit Die Index No.‡	Burndy Die Index No.‡	T&B Die Index No.‡	Wire Strip Length In.	Std. Pkg. Qty.
				W	B	T	L						
<b>BEST SELLER</b> LAB500-12-24R ◆	500 kcmil	0.5	1.75	1.62	3	0.46	6.8	Pink	P99	300	99	3.0625	2
<b>BEST SELLER</b> LAB600-12-24 ◆	600 kcmil			1.73		0.5	7.56	Black	P106	473	106		
<b>BEST SELLER</b> LAB750-12-24R ◆	750 kcmil			1.69	3.44	0.57	7.31	Red	P125	301	125		

‡Visit [www.panduit.com](http://www.panduit.com) for tool and die information

\*\*Consult cable manufacturer for voltage stress relief instructions with applications greater than 2000 V

◆NEMA hole sizes and spacing



### Like what you see and want more?

Visit [www.panduit.com](http://www.panduit.com) for the full offering of Panduit products



### Split Bolts, Copper

For Use with Copper Code Conductors

#### Type SBC

- Made from high strength copper alloy to resist corrosion and provide premium electrical and mechanical performance
- Offered with extra long body to allow connection of one or two taps to a single run conductor
- Wide wire range-taking capability minimizes inventory requirements
- Nut hex provides correct fit with socket, box, or open end wrenches resulting in proper torquing of electrical connection
- Pressure bar provides secure connection on a full range of conductor combinations used with each connector assuring premium wire pull-out strength
- UL Listed and CSA Certified for use up to 600 V and temperature rated 90°C
- UL Listed and CSA Certified for Direct Burial Grounding for connectors marked below

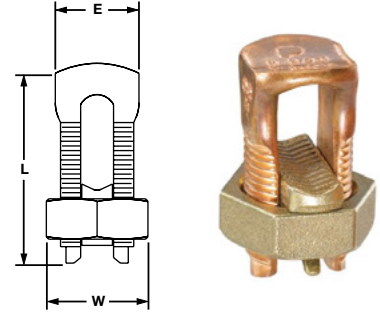

Part Number	Copper Conductor			Figure Dimensions In.			Std. Pkg. Qty.
	Range of Equal Run and Tap		Min Tap with One Max Run	E	W	L	
	Min	Max					
SBC8-C	#10 SOL	#8 STR	#16 STR	0.39	0.55	0.86	100
SBC6S-C	#8 SOL	#6 SOL	#16 SOL	0.41	0.62	0.95	
SBC4S-C		#6 STR		0.45	0.69	0.98	
<b>BEST SELLER</b> SBC2-C	#6 SOL	#2 STR	#14 STR	0.59	0.86	1.23	50
SBC1/0-L	#4 SOL	1/0 STR		0.75	0.93	1.55	
SBC2/0-Q	#2 SOL	2/0 STR		0.79	1.05	1.72	
SBC250-Q	#1 SOL	250 kcmil	#8 STR	1.03	1.36	2.09	25

### One-Hole, Straight Tongue, Barrel Post Lugs

For Use with Copper Code Conductors

#### Type ML

- Made from high strength electrolytic copper to provide premium electrical and mechanical performance
- Compact design saves space
- Wide wire range-taking capability minimizes inventory requirements
- Inspection window to visually assure full conductor insertion
- Plated steel set screw provides high strength, durable electrical contact between conductor and connector
- Flat bottom allows for complete contact with mounting surface
- UL Listed for use up to 600 V and temperature rated 90°C
- Tin plating is available, contact customer service

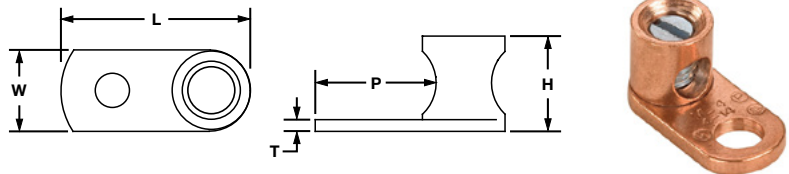

Part Number	Copper Conductor Size Range	Stud Hole Size In.	Hex Key Size In.	Figure Dimensions In.					Std. Pkg. Qty.
				L	W	H	T	P	
<b>BEST SELLER</b> ML4-CY	#14 SOL – #4 STR	0.25	**	1.11	0.54	0.55	0.09	0.63	100
<b>BEST SELLER</b> ML1/0-LY	#14 SOL – 1/0 STR	0.3125	0.25	1.54	0.73	0.79		0.80	50

\*\*Uses slotted head set screw



**PATENTED**

### One-Hole, Single Piece, Straight Fixed Tongue Lugs

For Use with Stranded Copper Code Conductors

#### Type CXS

- Made from a single piece of high strength electrolytic copper to provide premium electrical and mechanical performance
- Patented one piece design. Provides premium electrical and mechanical
- Wide wire range-taking capability minimizes inventory requirements
- Serrations incorporated in barrel of connector to provide premium wire pullout strength of wire termination
- Plated, fillister head, steel set screw provides high strength, durable electrical contact between conductor and connector
- cULus Listed for use for up to 600 V and temperature rated to 90 C where applicable

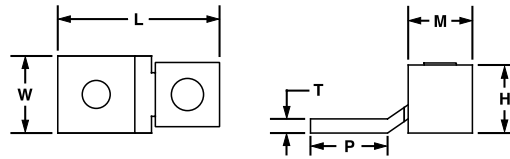

Part Number	Copper Conductor Size Range	Stud Hole Size In.	Figure Dimensions In.					Std. Pkg. Qty.
			L	W	H	T	M	
<b>BEST SELLER</b> CX35-36-C	14 AWG – 6 AWG	0.1875	1.08	0.38	0.39	0.05	0.47	100
CX70-14-C	14 AWG – 4 AWG	0.25	1.28	0.5	0.5	0.06	0.53	



### One-Hole, Offset Floating Tongue Lug

For Use with Stranded Copper Code Conductors

#### Type CB

- Made from high strength electrolytic copper to provide premium electrical and mechanical performance
- Wide wire range-taking capability minimizes inventory requirements
- Internal pressure bar and V-bottom collar provide uniform clamping force on conductor to assure positive contact between conductor and connector
- Inspection window to visually assure full conductor insertion
- Plated steel set screw provides high strength, durable electrical contact between conductor and connector
- cULus Listed for use up to 600 V and temperature rated to 90°C where applicable

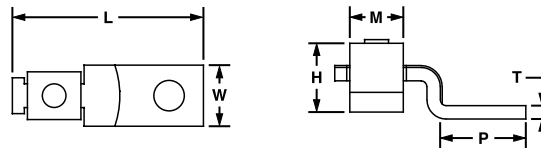

Part Number	Conductor Size Range	Current Rating (Amps)	Stud Hole Size In.	Hex Size In.	Figure Dimensions In.						Std. Pkg. Qty.
					L	W	H	T	P	M	
CB70-14-CY	#8 AWG – #2 AWG, (1) #8 AWG with (1) #4 AWG, (1) #8 AWG with (1) #6 AWG	90	0.25	**	1.55	0.47	0.64	0.08	0.80	0.50	100



### One-Hole, Single Barrel Lugs

For Use with Stranded Aluminum or Copper Code Conductors

#### Type LAMA

- Made from extruded aluminum alloy to provide premium electrical and mechanical performance for wide wire range-taking capability that helps minimize inventory requirements
- The plated steel or aluminum set screw provides a durable electrical contact between conductor and connector
- UL Listed and CSA Certified for use up to 600 V and UL temperature rated 90°C
- Tin-plated to inhibit corrosion

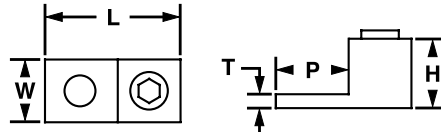

Part Number	Conductor Size Range	Stud Hole Size In.	Hex Key Size In.	Figure Dimensions In.					Std. Pkg. Qty.
				L	W	H	T	P	
LAMA6-14-QY	#14 AWG – #6 AWG	0.25	**	1.06	0.50	0.50	0.09	0.68	25
<b>BEST SELLER</b> LAMA2-14-QY	#14 AWG – #2 AWG		**	1.16		0.55	0.10	0.69	
LAMA1/0-14-QY	#14 AWG – 1/0 AWG		**	1.47	0.62	0.79	0.19	0.85	
LAMA2/0-14-QY	#14 AWG – 2/0 AWG		0.1875						
LAMA250-56-QY	#6 AWG – 250 kcmil	0.3125	0.3125	2.01	1.00	1.13	0.25	0.99	6
LAMA350-38-QY	#6 AWG – 350 kcmil	0.375		2.25	1.13	1.25		1.12	
LAM2A350-12-6Y		0.5		2.87	1.73	1.25		1.74	

The use of Panduit oxide inhibiting joint compound (CMP-100) is recommended for pad to pad and conductor connections  
 \*\*Uses slotted head set screw



### One-Hole, Two-Barrel Lugs

For Use with Stranded Aluminum or Copper Code Conductors

#### Type LAM2A

- Dual barrel provides termination of two conductors
- Made from high strength, extruded aluminum alloy to provide premium electrical and mechanical performance
- Tin-plated to inhibit corrosion
- Wide wire range-taking capability minimizes inventory requirements
- Inspection window to visually assure full conductor insertion
- Plated steel or aluminum set screw provides high strength, durable electrical contact between conductor and connector
- UL Listed and CSA Certified for use up to 600 V and temperature rated 90°C
- Available with NEMA hole sizes and spacing

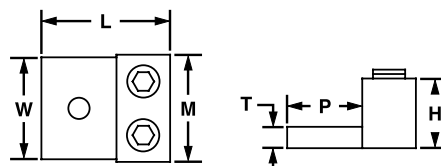

Part Number	Conductor Size Range	Stud Hole Size In.	Hex Key Size In.	Figure Dimensions In.						Std. Pkg. Qty.
				L	W	H	T	P	M	
LAM2A1/0-14-6Y	#14 AWG – 1/0 AWG	0.25	**	1.47	1.13	0.78	0.19	0.85	1.13	6
LAM2A250-38-6Y	#6 AWG – 250 kcmil	0.375	0.375	2.56	1.50	1.19	0.25	1.56	1.64	
LAM2A600-12-6Y	#2 AWG – 600 kcmil	0.5		3.19	2.00	1.56	0.44	1.81	2.38	

The use of Panduit oxide inhibiting joint compound (CMP-100) is recommended for pad to pad and conductor connections  
 \*\*Uses slotted head set screw





### In-Line Splicer/Reducer with Clear Insulation

For Use with Aluminum or Copper Code Conductors

#### Type PISR

- Flexible design – can be used as a splice or reducer
- Dual rated for use with copper or aluminum conductors
- Made from high strength, extruded aluminum alloy to provide premium electrical and mechanical performance
- Insulated with clear PVC to eliminate the need for taping and allow for visual inspection of the complete conductor insertion
- Each port pre-filled with oxide inhibiting joint compound seals out air and moisture to deter surface oxidation
- Wide wire range-taking capability minimizes inventory requirements
- Plated steel or aluminum set screw provides high strength, durable electrical contact between conductor and connector
- UL Listed and CSA Certified for use up to 600 V and UL temperature rated 90°C

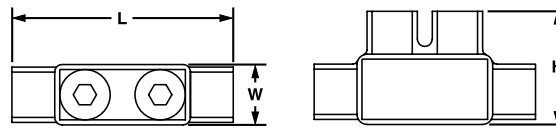

Part Number	Conductor Size Range	Figure Dimensions (In.)			Std. Pkg. Qty.
		L	W	H	
<b>PISR250-1</b>	250 kcmil – #10 AWG STR, #8 AWG SOL – #10 AWG SOL	4.00	1.25	2.24	1



### Multi-Tap Connectors with Clear Insulation, Single-Sided

For Use with Aluminum or Copper Code Conductors

#### Type PCSB-S

- Flexible design that can be used as a tap, splice, or dead-end connector
- Made from high strength, extruded aluminum alloy to provide premium electrical and mechanical performance
- Insulated with clear PVC to eliminate the need for taping and allow for visual inspection of the complete conductor insertion
- UL Listed and CSA Certified for use up to 600 V and temperature rated to 90°C

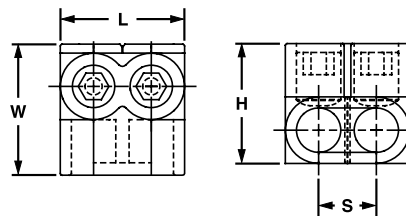

Part Number	Conductor Size Range	No. of Ports	Figure Dimensions In.				Hex Key Size In.	Std. Pkg. Qty.
			L	W	H	S		
<b>BEST SELLER</b> <b>PCSB4-2S-12Y</b>	#4 – #14 AWG STR #10 – #14 AWG SOL	2	1.23	1.25	1.25	0.53	0.125	12
<b>PCSB4-3S-12Y</b>		3	1.76					
<b>BEST SELLER</b> <b>PCSB2/0-2S-6</b>	2/0 – #14 AWG STR #10 – #14 AWG SOL	2	1.52	1.31	1.38	0.67	0.1875	6
<b>PCSB2/0-3S-6Y</b>		3	2.19					
<b>BEST SELLER</b> <b>PCSB250-2S-6Y</b>	250 kcmil – #10 AWG STR	2	2.03	2.00	2.13	0.94	0.3125	



### Multi-Tap Connectors with Clear Insulation, Single-Sided

For Use with Aluminum or Copper Code Conductors

#### Type PCSB

- Flexible design – can be used as a tap, splice, or dead end connector
- Body made from high strength, extruded aluminum alloy to provide premium electrical and mechanical performance
- Insulated with clear PVC to eliminate the need for taping and allow for visual inspection of the complete conductor insertion
- Each port pre-filled with oxide inhibiting joint compound seals out air and moisture to deter surface oxidation
- Wide wire range-taking capability minimizes inventory requirements
- Dual-sided entry allows offset and opposite entry for primary and secondary conductors
- Plated steel or aluminum set screw provides high strength, durable electrical contact between conductor and connector
- UL Listed and CSA Certified for use up to 600 V and temperature rated 90°C

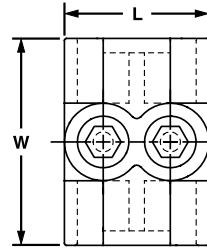

Part Number	Conductor Size Range	No. of Ports	Figure Dimensions In.				Hex Key Size In.	Std. Pkg. Qty.
			L	W	H	S		
<b>BEST SELLER</b> PCSB4-2-12Y	#4 – #14 AWG STR #10 – #14 AWG SOL	2	1.23	1.50	1.25	0.53	0.125	12
<b>BEST SELLER</b> PCSB2/0-2-12	2/0 – #14 AWG STR #10 – #14 AWG SOL		1.52	1.56	1.38	0.67	0.1875	
PCSB250-2-6Y	250 kcmil – #10 AWG STR		2.03	2.63	2.13	0.94	0.3125	
PCSB250-3-6Y		3	2.97					6

### Portable Manual Contour Crimp™ Controlled Cycle Tools

- Controlled cycle mechanism assures high quality, consistent terminations
- Ergonomic tool design assures operator comfort, safety, and performance
- Polypropylene handles provide chemical resistance and a cushioned, non-slip grip
- Tools incorporate multiple die pockets in rotating die wheel with push-button lockout

Part Number	Description	Std. Pkg. Qty.
CT-1700	Crimps Panduit #8 – #1 AWG non-insulated tubular terminals (S series), #8 – 1 AWG copper code conductor lugs and splices, #8 – 2 AWG copper flex conductor lugs, #6 – 4 AWG dual rated aluminum lugs and splices and CTAPF10-16 to CTAPF3-12 copper taps. Includes 5-position, color coded rotating die	1
CT-1701	Crimps Panduit #10 – #2 AWG non-insulated large gauge ring terminals (P series), #12 – 4 AWG non-insulated heavy duty ring terminals (P series), and #14 – 10 AWG copper code conductor lugs. Includes 5-position, rotating die	



CT-1700



CT-1701

### Portable Manual, Crimping Tools

- Ergonomic tool design assures operator comfort, safety, and performance
- 6-position die pockets in integrated rotating die wheel
- Provides UL Listed and CSA Certified connections
- No individual dies

Part Number	Description	Std. Pkg. Qty.
CT-810	Crimps #8, #6, #4, #2, #1, and 1/0 AWG power connector lugs	1
CT-1250	Crimps #1, 1/0, 2/0, and 4/0 AWG power connector lugs	



CT-810



CT-1250

### Portable Manual Uni-Die™ Quad-Point, Dieless, Hydraulic, 6.2 Ton, Crimping Tool

- Quad-point indent crimping feature with patented centering system, no dies required
- Cushioned grips prevent hands from slipping on tool, reduces fatigue
- Provides UL Listed and CSA Certified wire range-taking capability on Panduit® Pan-Lug™ Copper Lugs and Splices, minimizes connector inventory and saves cost
- Audible “pop-off” valve indicates crimp completion
- Closed head with bolt interlock, flip top style, rotatable 360 degrees
- Light weight, high quality aluminum housing and crimp head, results in lightweight tool and ease of operation
- 2-stage hydraulic system with rapid advance, double action handle and power stroke
- Automatic retraction when operation is complete
- Manual retraction if needed.
- Uses environmentally-friendly hydraulic oil, biodegradable



Part Number	Description	Std. Pkg. Qty.
<b>CT-980</b>	Hand-operated and light weight hydraulic crimping tool that is made of high quality aluminum that provides long-term dependability. Quad -point indent crimping feature with patented centering system, no dies required. Cushion grip prevents hands from slipping and reduces worker fatigue. This tool crimps select copper lugs and splices #4 AWG-750 kcmil code conductor along with aluminum lugs and splices #4 AWG - 500 kcmil. Reference our tooling charts for a full list of parts. Tool calibration solder slugs 10 pcs - normally included (CG-980SS)	1

### Portable Manual, Die Type, Hydraulic, 12 Ton, Crimping Tool

- High quality, durable tool construction provides long-term dependability
- Cushioned grip prevents hands from slipping on tool, reduces fatigue
- Uses Panduit CD-920 and CD-930 color-coded crimping dies to provide easy matching of crimping die to connector
- Audible “pop-off” valve indicates crimp completion
- Open “C” head, rotatable 350 degrees
- 2-stage hydraulic system: rapid advance, double action handle and power stroke
- Automatic retraction when operation is complete
- Manual retraction operation if needed
- Uses environmentally-friendly hydraulic oil, biodegradable
- CT-920/CV tool available with 2-layer PVC covered crimp head

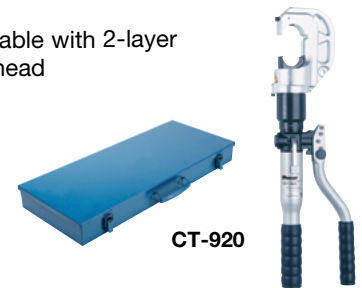

Part Number	Description	Compatible Dies and Adapters	Std. Pkg. Qty.
<b>CT-920</b>	Hand-operated and light weight hydraulic crimping tool that is made of high quality aluminum that provides long-term dependability. The cushion grip prevents hands from slipping and reduces worker fatigue. This tool crimps most Pan-Term® terminals, splices, disconnects, ferrules, and some copper lugs.	CD-920 , CD-930	1



## Portable Battery Powered Hydraulic Crimping Tools

- Crimping wire ranges are from 14 AWG - 1000 kcmil for flex and code wire
- New Diagnostics: New Bluetooth networked tools interface to diagnose any tool or a fleet of tools to keep optimal overview of inventory
- Improved Safety and Comfort: Updated designs focused on optimizing the tool center of gravity not only allows you to be more comfortable, but also more productive
- Upgraded Power Supply: High capacity 4.0 Ah Li-Ion Makita battery platform with active battery monitoring system improves your battery supply
- LED Display: Real-time communication of details associated with the tool, including battery charge, pressure level, and cycle information
- Enhanced Housing Construction: Protects internal components of the tool against dirt, debris and water intrusion
- Reverse Tapered Hand Grip: Increases grip strength and optimal hand positioning to avoid user fatigue
- Improved Software: i-press software records your operations to create a project report via Bluetooth to your cell or desktop
- OSHA mandated electrical and mechanical product safety requirements
- UL 60745-1 and CSA No. 60745-1 for safety for handheld, motor operated electric tools
- EU machinery directive and EMC directive Certified to SiQ to IEC/EN 62841-1, tested to EN 61000 series
- ISO 12100, Machinery Safety Risk Assessment, including ergonomics
- 5 Year Warranty

### In Line Type Crimpers

Part Number	Crimp Force	Tool Type	Terminates Panduit Compression Connectors
<b>CT-2600/LBT</b>	4-ton	Die	<ul style="list-style-type: none"> <li>• Tin and nickel plated #8 – 2 AWG high temperature large wire, non-insulated, vinyl and KYNAR** insulated ring terminals</li> <li>• 8 AWG - 300 kcmil copper Code lugs and splices.</li> <li>• 6 AWG - 2/0 AWG Dual rated aluminum lugs and splices</li> </ul>
<b>CT-3001/STBT</b>	6.7-ton	Die	<ul style="list-style-type: none"> <li>• Copper lugs and splices #8 AWG–600 kcmil code conductor</li> <li>• Copper lugs #8 AWG – 313 kcmil flex conductor</li> <li>• Aluminum lugs #6 AWG - 350 kcmil code conductor</li> <li>• Large Ferrules #1 AWG - 444 kcmil</li> <li>• Copper CTAPF taps #10 – 3/0 AWG code conductor</li> <li>• Copper CTAP taps #8 – #2 AWG code conductor</li> <li>• Copper S Series Tubular Terminals #8 AWG –250 kcmil code conductor</li> <li>• Copper Metric lugs and splices for 10mm<sup>2</sup> – 240mm<sup>2</sup> class 2R conductor, 10mm<sup>2</sup> - 95mm<sup>2</sup> class 5f/6f</li> </ul>
<b>CT-3001/CCPBT</b>	6.7-ton	Die	<ul style="list-style-type: none"> <li>• Copper lugs and splices #8 AWG – 600 kcmil code conductor</li> <li>• Copper lugs #8 AWG – 373 kcmil flex conductor</li> <li>• Aluminum lugs #6 AWG - 350 kcmil code conductor</li> <li>• Large Ferrules #1 AWG - 444 kcmil</li> <li>• Copper CTAPF taps #10 – 3/0 AWG code conductor</li> <li>• Copper CTAP taps #8 – #2 AWG code conductor</li> <li>• Copper S Series Tubular Terminals #8 AWG – 250 kcmil code conductor</li> <li>• Copper Metric lugs and splices for 10mm<sup>2</sup> – 240mm<sup>2</sup> class 2R conductor, 10mm<sup>2</sup> - 95mm<sup>2</sup> class 5f/6f</li> <li>• Cut and Punch Capabilities</li> </ul>
<b>CT-3980/BT</b>	6.7-ton	Dieless Indenter	<ul style="list-style-type: none"> <li>• Copper lugs and splices #8 AWG – 600 kcmil code conductor</li> <li>• Copper lugs #8 AWG – 373 kcmil flex conductor</li> <li>• Aluminum lugs for #6 AWG - 350 kcmil code conductor</li> </ul>



- Product Showcase
- Abrasion Protection
- Cable Cleats
- Cable Ties
- Cable Tie Accessories
- Cable Tie Tools
- Identification Products
- Power Connectors
- Grounding Connectors
- Safety Solutions
- Stainless Steel Ties
- Terminals
- Wiring Duct
- Part Number Index

(continued on next page)

### Portable Battery Powered Hydraulic Crimping Tools *(continued)*

#### Pistol Grip Type Crimpers

Part Number	Crimp Force	Tool Type	Terminates Panduit Compression Connectors
<b>CT-2980/STBT</b>	6.2-ton	Dieless Quad-Point	<ul style="list-style-type: none"> <li>• Copper lugs and splices #4 AWG – 750 kcmil code conductor</li> <li>• Aluminum lugs and splices #4 AWG – 500 kcmil code conductor</li> </ul>
<b>CT-2931/STBT</b>	12-ton	Die	<ul style="list-style-type: none"> <li>• Copper lugs and splices #8 AWG – 750 kcmil code conductor</li> <li>• Copper lugs #8 AWG – 535 kcmil flex conductor</li> <li>• Copper S Series, Tubular Terminals #8 AWG – 250 kcmil code conductor</li> <li>• Copper Metric lugs and splices 10mm<sup>2</sup> – 400mm<sup>2</sup> class 2R conductor 10mm<sup>2</sup> - 300mm<sup>2</sup> Class 5f/6f</li> <li>• StructuredGround™ Direct Burial connectors #6 AWG – 250 kcmil code conductor and select 500 kcmil conductor combinations</li> <li>• Copper CTAPF taps #10 – 3/0 AWG code conductor</li> <li>• Copper CTAP taps #8 – 4/0 AWG code conductor</li> <li>• Copper HTCT taps #14 AWG – 250 kcmil code conductor, #14 - 4/0 AWG flex conductor</li> <li>• Aluminum lugs and splices for #6 AWG – 600 kcmil code conductor</li> </ul>
<b>CT-2920/CCPBT</b>	12-ton	Die	<ul style="list-style-type: none"> <li>• Copper lugs and splices #8 AWG – 750 kcmil code conductor</li> <li>• Copper lugs and splices 4 AWG - 750 kcmil code conductor w/UA12ID dieless indenter adapter accessory</li> <li>• Copper lugs #8 AWG – 535 kcmil flex conductor</li> <li>• Copper S Series Tubular Terminals #8 AWG – 250 kcmil code conductor</li> <li>• Copper lugs and splices 10mm<sup>2</sup> – 400mm<sup>2</sup> class 2R conductor, 10mm<sup>2</sup> - 300mm<sup>2</sup> Class 5f/6f</li> <li>• StructuredGround™ Direct Burial connectors #6 AWG – 1/0 AWG code conductor</li> <li>• Copper CTAP taps #8 – 4/0 AWG code conductor</li> <li>• Copper HTCT taps #14 AWG – 2 AWG code conductor</li> <li>• Aluminum lugs and splices #6 AWG – 600 kcmil code conductor</li> <li>• Aluminum lugs #6 AWG - 600 kcmil code conductor w/UA12ID dieless indenter adapter accessory.</li> <li>• Cut and Punch capabilities</li> </ul>
<b>CT-2940/STBT</b>	15-ton	Die	<ul style="list-style-type: none"> <li>• Copper lugs and splices #8 AWG – 1000 kcmil code conductor</li> <li>• Copper lugs #8 AWG – 777.7 kcmil flex conductor</li> <li>• Copper S Series Tubular Terminals #8 – 250 kcmil code conductor</li> <li>• Copper Metric lugs and splices 10mm<sup>2</sup> – 630mm<sup>2</sup> class 2R and, 10mm<sup>2</sup> - 300mm<sup>2</sup> Class 5f/6f metric conductor</li> <li>• StructuredGround™ Direct Burial connectors #6 AWG – 500 kcmil code conductor</li> <li>• Copper CTAPF taps #10 – 3/0 AWG code conductor</li> <li>• Copper CTAP taps #8 – 4/0 AWG code conductor</li> <li>• Copper HTCT taps #14 AWG – 250 kcmil code conductor, #14 – 4/0 AWG flex conductor</li> <li>• Aluminum lugs and splices #6 AWG – 1000 kcmil code conductor</li> </ul>





# GROUNDING CONNECTORS

---

Telecommunications Grounding Busbars .....	131
Universal Ground Bars .....	132
Grounding Busbar Kits .....	132
Equipment Bonding Jumper Kit .....	134
Armored Cable Grounding Kit.....	134
Retrofit Rack Grounding Kit.....	135
Green Bonding Cage Nut Kit.....	135
Bonding Hardware Kit .....	135
Auxiliary Cable Bracket .....	136
Code/Flex Conductor HTAP .....	136
E-Style Grounding Connectors .....	138
Grounding Cross Connectors.....	139
C-Style Grounding and Power Connector.....	140
Universal Beam Grounding Clamp .....	141
Code Conductor, Heavy Duty, CTAP.....	141
Bronze Service Post Connector .....	142
Aluminum One-Hole Grounding Lay-In Lug.....	142



**Panduit Grounding & Bonding systems provide high quality, visually verifiable connections and dedicated grounding paths to maintain system performance and protect personnel and equipment.**

Discover more at [www.panduit.com/grounding-and-bonding](http://www.panduit.com/grounding-and-bonding)





### Telecommunications Grounding Busbars

#### Type GB

- Meet BICSI and ANSI/TIA-607-D (rev. 2019) requirements for network systems grounding applications
- Made of high conductivity copper and tin-plated to inhibit corrosion
- Comes pre-assembled with brackets and insulators attached for a quick installation
- The insulators provide 600 V of insulation and use of Panduit self-laminating laser/ink jet labels to identify busbars



Part Number	Bar Size	No. of Mounting Positions		Std. Pkg. Qty.
		1/4" Stud Hole with 5/8" Hole Spacing	Change to 3/8" Stud Hole with 1" Hole Spacing	

#### Telecommunications Grounding Busbars (TGB)

<b>BEST SELLER</b> GB2B0304TPI-1	1/4" x 2" x 10"	4	3	1
<b>BEST SELLER</b> GB2B0306TPI-1	1/4" x 2" x 12"	6		
GB2B0312TPI-1	1/4" x 2" x 20"	12		
<b>BEST SELLER</b> GB2B0514TPI-1	1/4" x 2" x 24"	14	5	

#### Telecommunications Main Grounding Busbars (TMGB)

<b>BEST SELLER</b> GB4B0612TPI-1	1/4" x 4" x 12"	12	6	1
<b>BEST SELLER</b> GB4B0624TPI-1	1/4" x 4" x 20"	24		
GB4B1028TPI-1	1/4" x 4" x 24"	28	10	

### NEMA Hole Pattern Grounding Busbar

#### Type GBN

- Provided with standard NEMA hole pattern spacing
- Made of high conductivity copper and tin-plated to inhibit corrosion
- Come pre-assembled with brackets and insulators attached
- Insulators provide 600 V of insulation



Part Number	Bar Size	No. of Mounting Positions	Std. Pkg. Qty.
		1/4" Stud Hole with 1 3/4" Hole Spacing	
GB4N0016TPI-1	1/4" x 4" x 24"	16	1



**Like what you see and want more?**

Visit [www.panduit.com](http://www.panduit.com) for the full offering of Panduit products



### Universal Ground Bars

**For Use with Stranded and Solid Copper Conductors**

- Securely terminates the main equipment grounding conductor with a compression or mechanical connector in any control panel or enclosure
- Accepts #14 – #4 AWG wire in wire ports and up to a 2/0 AWG main equipment grounding conductor with a compression or mechanical connector

- Several mounting options are available, including bonding stand-offs, isolation stand-offs, and direct mounting to a panel



Part Number	Number of Ports	Wire Port Wire Range AWG	1/4-28 Wire Port Screw Qty	Figure Dimensions In. (mm)				Mounting Holes to Panel Width
				Length	Width at Top	Width at Base	Height	
<b>BEST SELLER</b> UGB2/0-414-6	6	14 AWG –4 AWG	8	4.92 (125.0)	0.62 (15.7)	0.44 (11.1)	0.48 (12.2)	2.37 (61.1)
<b>BEST SELLER</b> UGB2/0-414-12	12		14	8.28 (210.3)				5.73 (145.4)
<b>BEST SELLER</b> UGB2/0-414-18	18		20	11.64 (295.7)				9.09 (230.8)



UGB-B-SO



UGB-IN-SO

#### Accessories

Part Number	Description	Length In. (mm)	Width In. (mm)	Height In. (mm)
<b>BEST SELLER</b> UGB-B-SO	Universal ground bar bonding stand-offs; includes two stand-offs and hardware	2.34 (59.3)	0.63 (15.9)	0.75 (19.1)
UGB-IN-SO	Universal ground bar isolation stand-offs; includes two stand-offs and hardware	1.57 (40)	0.59 (15.0)	0.98 (25.0)



### Grounding Busbar Kit for Threaded Rail Fasteners



Part Number	Description	Std. Pkg. Qty.
<b>BEST SELLER</b> RGRB19U	Grounding busbar; 19" (483mm) length; tin-plated; twenty holes arranged for flexibility in mounting with twenty #12-24 x 0.5" hex head screws installed; mounting hole sets have 0.625" (15.9mm) spacing; provided with two each #12-24 x 0.5", M6 x 12mm thread-forming screws, and two #12 flat washers for mounting	1



**Like what you see and want more?**

Visit [www.panduit.com](http://www.panduit.com) for the full offering of Panduit products



### Grounding Busbar Kits

- Provide the common grounding point within the cabinet
- Optimized for installation on 19" racks or cabinets that meet EIA-310
- Can be positioned anywhere on the rack or cabinet
- Available pre-assembled with twenty mounting screws for quick and easy installation
- Engineered to comply with US and International grounding requirements

Part Number	Description	Std. Pkg. Qty.
-------------	-------------	----------------

#### Grounding Busbar Kit for Threaded Rail Fasteners

<b>BEST SELLER</b> <b>RGRB19Y</b>	Grounding busbar; 19" (483mm) length; tin-plated copper; fourteen holes arranged for flexibility in mounting; provided with two each #12-24 x 0.5" and M6 x 12mm thread-forming screws	1
--------------------------------------	--	---

#### Grounding Busbar Kit for Cage Nut Rail Fasteners

<b>RGRB19CN</b>	Grounding busbar; 19" (483mm) length; tin-plated copper; twenty holes arranged for flexibility in mounting with twenty #12-24 x 0.5" hex head screws installed; mounting hole sets have 0.625" (15.9mm) spacing; provided with two cage nut bonding studs and four #12-24 bonding nuts	1
-----------------	--	---



### Grounding Strip Kits

- Bonds with Threaded Rail Fasteners with an EIA Universal Mounting Hole Pattern
- Engineered to Comply with US and International Grounding Requirements



Part Number	Description	Length In. (m)	Width In. (mm)	Thickness In. (mm)	Std. Pkg. Qty.
<b>BEST SELLER</b> <b>RGS134-1Y</b>	Grounding strip; 45 RU. Provided with 0.16 oz. (5cc) of antioxidant, one grounding sticker and three each #12-24 x 1/2" and M6 x 12mm thread-forming screws	78.65 (2)	0.67 (17)	0.05 (1.27)	1
<b>BEST SELLER</b> <b>RGS13451-1</b>	Grounding strip; 51 RU. Provided with 0.16 oz. (5cc) of antioxidant, one grounding sticker and three each #12-24 x 1/2" and M6 x 12mm thread-forming screws	89.15 (2.3)			



### Grounding Strip Kits for Cage Nut Rail Fasteners

- Bonds to equipment mounting rail on rack or cabinet
- EIA Universal mounting hole pattern
- Engineered to comply with US and International grounding requirements



Part Number	Description	Length In. (m)	Width In. (mm)	Thickness In. (mm)	Std. Pkg. Qty.
<b>RGS134B-1</b>	Grounding strip; 45 RU. Provided with 0.16 oz. (5cc) of antioxidant, one grounding sticker, three cage nut bonding studs, eight #12-24 bonding nuts and three strip clips	78.70 (2)	0.67 (17)	0.05 (1.27)	1
<b>BEST SELLER</b> <b>RGS134B48-1</b>	Grounding strip; 48 RU. Provided with 0.16 oz. (5cc) of antioxidant, one grounding sticker, three cage nut bonding studs, eight #12-24 bonding nuts and three strip clips	83.90 (2.1)		0.03 (0.76)	





### Equipment Jumper Kits

- Bond network equipment to grounding strip or grounding busbar
- Available with both ends factory terminated to provide a bolt-on solution
- Available with one end factory terminated to attach to the grounding strip or grounding busbar; free end accommodates unique equipment terminations
- Use jumpers with 90° bent lug, on grounding strip side, for high-density grounding requirements up to one ground point per RU
- Use jumpers with 45° bent lugs, on grounding strip side, for improved cable management
- Engineered to comply with US and International grounding requirements

#### #10 AWG (6mm<sup>2</sup>) Equipment Jumpers Factory Terminated on Both Ends

Part Number	Length In. (m)	Angle	Description	Std. Pkg. Qty.	Std. Ctn. Qty.
RGEJ1024PFY	24 (0.61)	90°	#10 AWG (6mm <sup>2</sup> ) jumper; bent lug on grounding strip side to straight lug on equipment; provided with 0.16 oz. (5cc) of antioxidant and two each #12-24 x 1/2", M6 x 12mm, #10-32 x 1/2" and M5 x 12mm thread-forming screws	1	10
RGEJ1024URT	24 (0.61)	Straight	#10 AWG (6mm <sup>2</sup> ) jumper, 24 in. (609.6mm) L, pre-terminated with two #10 (5.3mm) stud hole ring terminals to provide a bolt-on solution for grounding network equipment		

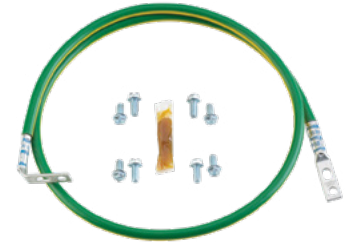

RGEJ1024PFY

### Armored Cable Grounding Kit

- Provides a secure bond to the armor sheath on indoor and indoor/outdoor fiber optic cables at both cassette and enclosure ends
- Worm-gear design evenly distributes forces across the armor
- Made from steel and tin-plated copper for chemical compatibility with common armor for long-term reliability
- Black insulating cover protects and hides the connection from incidental contact to prolong connection integrity
- Complies with industry requirements ensuring a high level of reliability and safety

Part Number	Description	Std. Pkg. Qty.
<b>BEST SELLER</b> ACG24K	#6 AWG (16mm <sup>2</sup> ) jumper for armored cable diameter up to 0.84" (21.3mm); 24" (609.6mm) length; factory terminated on one end with LCC6 two-hole copper compression lug and the other end with grounding terminal; provided with two each #12-24 and M6 thread-forming screws and a black polypropylene terminal cover	1



**Like what you see and want more?**

Visit [www.panduit.com](http://www.panduit.com) for the full offering of Panduit products



### Retrofit Rack Grounding Kit

- Provide a dedicated ground system to maintain system performance and protect network equipment when equipment is already installed
- Optimized for installation on 19" racks that meet EIA-310, with functioning equipment, and are deployed in the field
- Provide a complete system of matched compor can be easily selected to save cost and labor
- Thread-forming screws eliminate the need to manually remove paint from the rack
- Engineered to comply with US and International grounding requirements

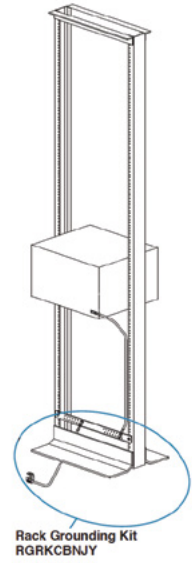

Rack Grounding Kit RGRKCBNJY

#### Busbar and Jumper Kit

Part Number	Description	Std. Pkg. Qty.
<b>RGRKCBNJY</b>	Rack grounding kit to ground the rack; includes one RGRB19U busbar, one HTCT250-2-1_HTAP, and one RGREJ696Y grounding jumper	1

### Green Bonding Cage Nut Kit **PATENTED**

- Creates an electrical bond between the mounting rails and equipment that conforms to EIA-310 specifications for racks and cabinets
- Made from high carbon steel and installed with a Phillips, flat blade, or nut screwdriver

Part Number	Description	Std. Pkg. Qty.
<b>CNBK</b>	Green bonding cage nut, includes 50 #12-24 bonding cage nuts (.06 - .11 thick panel) and 50 #12-24 x 0.5" bonding screws with #2 Phillips/slotted combo hex head (use 0.3125" or 8mm socket)	1



### Bonding Hardware Kit **PATENTED**

- Incorporates paint piercing serrations to create a bond point between the rack or cabinet and painted patch panels, mounted equipment, servers, busbars, and jumpers
- Thread-forming, provide a bond to the rack or cabinet by removing paint from holes and minimizing metal shavings
- Green color-coding to indicate bonding application

#### Bonding Stud Kits for Threaded Rail Fasteners

Part Number	Description	Std. Pkg. Qty.
<b>TRBSK</b>	Bonding stud kit for threaded #12-24 rail fasteners; includes 25 bonding studs and 50 bonding nuts	1



#### StructuredGround™ Mounting Hardware for TEBC Kits

Part Number	Description	Std. Pkg. Qty.
<b>HDW1/4-A-KT</b>	Stainless steel mounting hardware for busbar; two 1/4-20 hex bolts, two 1/4-20 hex nuts, four 1/4 flat washers and two 1/4 Belleville compression washers. Mounting hardware for rack or cabinet; two #10-32 thread-forming screws and two MS thread-forming screws	1



Hardware for TEBC Kits



### Auxiliary Cable Bracket **PATENTED**

- Bonds ladder rack, wire basket and Panduit® Wyr-Grid® System sections together without drilling holes
- Supports grounding conductors in the telecommunications room, allows separation of grounding conductors from other cables
- Holds up to four conductors in sizes up to 750 kcmil
- Bonds to all 1" and 2" ladder rack rails
- Paint piercing teeth provide electrical continuity between cable pathway sections while minimizing debris
- Front and back mounting screw options allow easy installation and visual inspection
- GACB-2 can be mounted above or below the cable pathway system for flexibility
- Brackets meet TIA-607-C

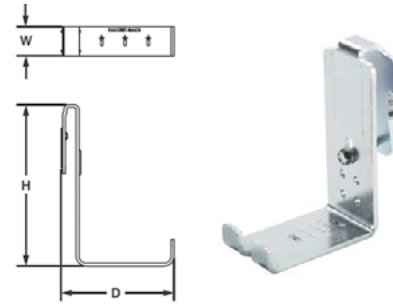

Part Number	Description	Std. Pkg. Qty.	Std. Ctn. Qty.
<b>GACB-2</b>	Auxiliary cable bracket; 1.63" (41.4mm) W, 3.95" (100.3mm) H; 5.22" (132.6mm) D; provided with one mounting screw	1	10



### Code/Flex Conductor HTAP

**For Making Parallel and Multiple Tap Connections on Code and Flex Conductors**

#### Type HTCT

- Used to tap into continuous conductors as a splice or pig tailing
- Terminates a wide range of conductor sizes and combinations of code and flex conductors Class G, H, I, and Diesel Locomotive to suit a variety of applications
- The slotted design allows quick and easy assembly of conductor to HTAP using three Panduit 94V-0 cable ties
- UL Listed and CSA Certified for applications up to 600 V when crimped with Panduit and specified competitor crimping tools and Panduit crimping dies

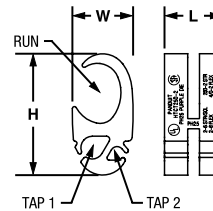

Part Number	Wire Strand Type	Copper Conductor Size Range				Figure Dimensions In. (mm)			Panduit Die Color and Die No.	Wire Strip Length In. (mm)	Std. Pkg. Qty.
		Run	Tap 1	Tap 2	Tap 3	L	W	H			
<b>HTCT250-2-1</b>	Code	250 kcmil – #2 AWG (120 – 35)	#2 – #6 AWG STR/SOL (25 – 16)	#8 – #14 AWG (6 – 2.5)	—	0.92 (23.4)	0.96 (24.4)	1.92 (48.8)	Purple PH25	1 (25)	
	Flex	4/0 – #2 AWG (95 – 35)	#2 – #8 AWG (25 – 10)								
<b>HTCT2-2-1</b>	Code	#2 – #6 AWG STR/SOL (25 – 16)	#2 – #6 AWG STR/SOL (25 – 16)	#8 – #14 AWG (6 – 2.5)	#8 – #14 AWG (6 – 2.5)	0.76 (19.3)	0.61 (15.5)	1.55 (39.4)	Brown PH2	13/16 (21)	
	Flex	#2 – #8 AWG (25 – 10)	#2 – #8 AWG (25 – 10)								



### Clear Covers for HTCT HTAPs

**PATENTED**

- Made of high-impact plastic to provide high-impact strength and 360° inspections of crimped connection to assure the crimp is complete and the correct die was used
- Incorporate dual self-latching spring loaded latches and supplied with two Panduit UL 94V-0 cable ties to allow for easy snap-on assembly and ensure covers are secured
- Low profile design minimizes space requirements
- Each cover half supports installation information labels inside plastic retainer strips to allow labels to be viewed on either side of cover and to protect labels from being removed

- Incorporate molded in flash barriers which encompass the HTAP installation providing protection against electrical flash over
- UL 94V-0 flame rating and oxygen index of 28 providing self-extinguishing, flame retardant properties
- Part number, voltage rating, temperature rating and HTCT part number molded into cover for easy identification
- Flexible fingers located at each end of cover prevent foreign objects from entering cover and are made from ductile plastic material that allows easy installation and will not damage conductor insulation

Part Number	Use with HTAP Part Number	Figure Dimensions			Std. Pkg. Qty.
		L	W	H	
CLRCVR2-1	HTCT2-2-1	5.10	1.66	1.40	1
CLRCVR3-1	HTCT250-2-1, HTCT250-250-1	5.35	2.16		



Labels for clear covers are sold separately and are printed with the Panduit® PanTher™ LS8E Hand-Held Thermal Transfer Printer, see [www.panduit.com](http://www.panduit.com) for more information



**Like what you see and want more?**

Visit [www.panduit.com](http://www.panduit.com) for the full offering of Panduit products



### E-Style Grounding Connectors

**PATENTED**

#### Type GCE

- Designed to enhance the crimp process using technology that meets the IEEE Std 837 - 2002 and REV 2014
- With wide range-taking ability and multi-conductor design provides flexibility with a minimum number of parts
- The slotted design allows quick and easy assembly while the pre-applied conductive antioxidant compound ensures a high quality mechanical and electrical bond and the UL 467 Listed and CSA 22.2
- Complies with vibration tests per MIL-STD-202G (METHOD 201A)
- Not rated for use with galvanized ground rods and/or galvanized cable

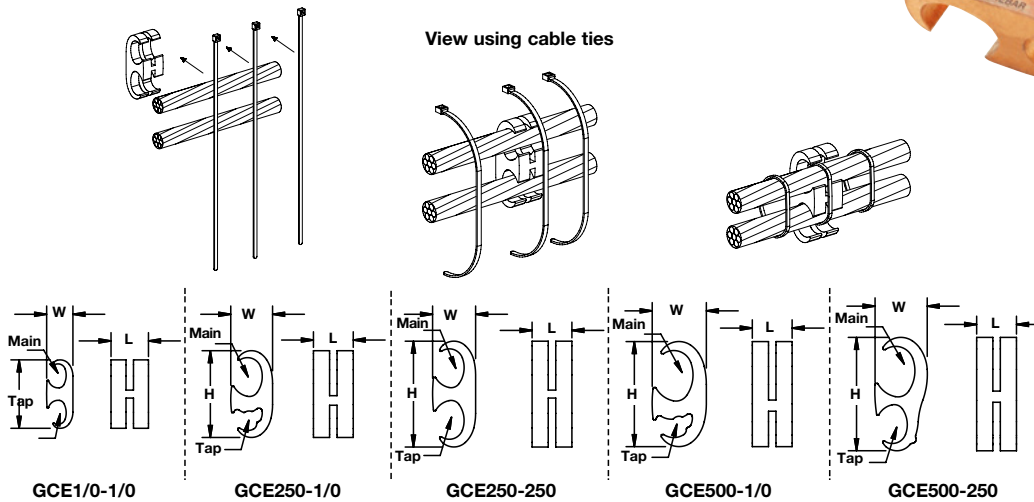

Part Number	Element	Copper Conductor Size Range AWG (mm <sup>2</sup> )	Ground Rod Size In. (mm)	Rebar Size In. (mm)	Figure Dimensions In. (mm)			Panduit Color Code	Panduit Part and Die Index No.	Std. Pkg. Qty.
					L	W	H			
<b>BEST SELLER</b> GCE1/0-1/0-L	Main	#6 SOL - 1/0 STR (16 - 50)	—	—	0.94 (23.9)	0.66 (16.8)	1.72 (43.7)	Red	CD-930G-1/0 PG10	1
	Tap									
<b>BEST SELLER</b> GCE250-1/0-Q	Main	1/0 STR - 250 kcmil (70 - 120)	0.5 - 0.625 (12.7 - 15.9)	0.375 - 0.5, #3 - #4 (9.5 - 12.7), (#10 - #13)	1.00 (25.4)	1.05 (26.7)	2.18 (55.4)	Black	CD-930G-250 PG25	
	Tap	#6 SOL - 1/0 STR (16 - 50)	—	—	1.00 (25.4)	1.05 (26.7)	2.18 (55.4)			
<b>BEST SELLER</b> GCE250-250-Q	Main	1/0 STR - 250 kcmil (70 - 120)	0.5 - 0.625 (12.7 - 15.9)	0.375 - 0.5, #3 - #4 (9.5 - 12.7), (#10 - #13)	1.00 (25.4)	1.08 (27.4)	2.66 (67.6)	Black	CD-930G-250 PG25	
	Tap				1.00 (25.4)	1.08 (27.4)	2.66 (67.6)			
<b>BEST SELLER</b> GCE500-1/0-X	Main	250 - 500 kcmil (150 - 240)	0.5 - 0.75 (12.7 - 19.1)	0.625 - 0.75, #5 - #6 (15.9 - 19.1), (#16 - #19)	1.00 (25.4)	1.36 (34.5)	2.64 (67.1)	Blue	CD-930G-500 PG50	
	Tap	#6 SOL - 1/0 STR (16 - 50)	—	—	1.00 (25.4)	1.36 (34.5)	2.64 (67.1)			
<b>BEST SELLER</b> GCE500-250-X	Main	250 - 500 kcmil (150 - 240)	0.5 - 0.75 (12.7 - 19.1)	0.625 - 0.75, #5 - #6 (15.9 - 19.1), (#16 - #19)	1.00 (25.4)	1.32 (33.4)	2.85 (72.4)	Blue	CD-930G-500 PG50	
	Tap	1/0 STR - 250 kcmil (70 - 120)	—	—	1.00 (25.4)	1.32 (33.4)	2.85 (72.4)			





### Grounding Cross Connectors **PATENTED**

#### Type GCC

- Only a single die required to crimp each element, which speeds installation and reduces costs
- Wide range-taking ability and multi-conductor design provide flexibility with a minimum number of parts, allowing for conductor to conductor, conductor to rebar, and conductor to ground rod applications
- Designed for the enhanced crimp process using patent pending technology meets IEEE Std 837 - 2002 and REV 2014
- Slotted design allows quick and easy assembly of conductor to connector using Panduit cable ties, included
- Pre-applied conductive antioxidant compound ensures a high quality mechanical and electrical bond, speeding installation
- Color-coded and marked with Panduit die index numbers for proper crimp die selection
- UL 467 Listed and CSA 22.2 Certified for grounding and bonding suitable for direct burial in earth or concrete when crimped with Panduit and specified competitor crimping tools and Panduit dies
- Complies with vibration tests per MIL-STD-202G (METHOD 201A)
- Not rated for use with galvanized ground rods and/or galvanized cable

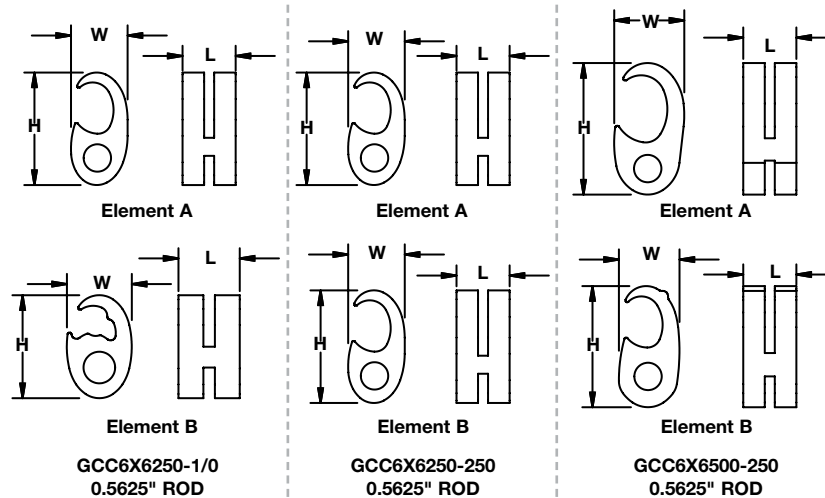

Part Number	Element	Copper Conductor Size Range AWG (mm <sup>2</sup> )	Ground Rod Size In. (mm)	Rebar Size In. (mm)	Figure Dimensions In. (mm)			Panduit Color Code	Panduit Part and Die Index No.	Std. Pkg. Qty.
					L	W	H			
GCC6X6250-1/0	A	#2 SOL - 250 kcmil (35 - 120)	0.5 - 0.625 (12.7 - 15.9)	0.375 - 0.5, #3 - #4 (9.5 - 12.7), (#10 - #13)	1.00 (25.4)	1.06 (26.9)	2.12 (53.8)	Black	CD-930G-250 PG25	1
	B	#6 SOL - 1/0 STR (16 - 50)	-	-			1.68 (42.7)			
GCC6X6500-250	A	250 - 500 kcmil (150 - 240)	0.5 - 0.75 (12.7 - 19.1)	0.625 - 0.75, #5 - #6 (15.9 - 19.1), (#16 - #19)	1.00 (25.4)	1.32 (33.5)	2.48 (63.0)	Blue	CD-930G-500 PG50	
	B	#2 SOL - 250 kcmil (35 - 120)	-	-			1.16 (29.5)			

- Product Showcase
- Abrasion Protection
- Cable Cleats
- Cable Ties
- Cable Tie Accessories
- Cable Tie Tools
- Identification Products
- Power Connectors
- Grounding Connectors
- Safety Solutions
- Stainless Steel Ties
- Terminals
- Wiring Duct
- Part Number Index



### C-Style Grounding and Power Connectors

**For Use with Stranded and Solid Copper Conductors**  
**Type CTAPR**

- Wide range-taking ability and multi-conductor design provide flexibility with a minimum number of parts allowing conductor to conductor and conductor to round rod applications
- Made from heavy wall, extruded, high conductivity copper provides high strength and premium electrical properties
- Pre-applied conductive antioxidant compound ensures a high quality mechanical and electrical bond, speeding installation
- Marked with Panduit die index numbers for proper crimp die selection
- UL 467 Listed for grounding and bonding suitable for direct burial in earth and concrete when crimped with select Panduit and specified competitor crimp tools and crimp dies
- UL 486A-486B Listed for wire to wire power applications up to 35kV and temperature rated 90C with select Panduit and specified competitor crimp tools and crimp dies

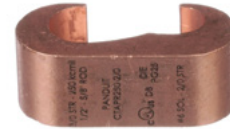

Part Number	Element	Copper Conductor Range AWG (mm <sup>2</sup> )	Ground Rod Size In. (mm)	Figure Dimensions In. (mm)			Panduit Die Index Code	Std. Pkg. Qty.
				Length	Width	Height		
CTAPR2-2-L	Main	6 STR – 2 STR 6 SOL – 1 SOL (16 – 25 STR) (16 – 35 SOL)	0.25 (6.4) Copper	0.75 (19.1)	0.56 (14.2)	1.16 (29.5)	PC	50
	Tap		NA					
CTAPR2/0-2-L	Main	1 STR – 2/0 STR (50)	0.375 (9.0) Copper Clad		0.72 (18.2)	1.43 (36.3)	PO	
	Tap		NA					
CTAPR2/0-2/0-L	Main	1 STR – 2/0 STR (50)	0.375 (9.0) Copper Clad		0.74 (18.8)	1.55 (39.4)	PG25	
	Tap		NA					
CTAPR250-2/0-L	Main	3/0 STR – 250 kcmil (95 – 120)	0.5 – 0.625 (12.8 – 14.2) Copper Clad		0.93 (23.6)	1.98 (50.3)	PG25	
	Tap		NA					
CTAPR250-250-L	Main	3/0 STR – 250 kcmil (95 – 120)	0.5 – 0.625 (12.8 – 14.2) Copper Clad		0.94 (23.9)	2.07 (52.6)	P500	
	Tap		NA					
CTAPR500-2/0-X	Main	300 kcmil – 500 kcmil (185 – 240)	0.75 (17.2) Copper Clad	0.88 (22.4)	1.23 (31.2)	2.42 (61.5)	P500	
	Tap		NA					
CTAPR500-250-X	Main	300 kcmil – 500 kcmil (185 – 240)	NA	1.34 (33.9)	2.69 (68.2)	P500		
	Tap						3/0 STR – 250 kcmil (95 – 120)	
CTAPR500-500-X	Main	300 kcmil – 500 kcmil (185 – 240)	NA	1.10 (27.9)	1.36 (34.5)	2.92 (74.2)	P500	
	Tap							300 kcmil – 500 kcmil (185 – 240)

\*CTAPR500-500 and CTAPR500-250 cannot be installed with a CT-2920, when installing CTAPR Connectors with the CT-920CH, use Blackfin tool only  
 \*\*CTAPR500-500 cannot be installed with a CT-930CH or CT-930



### Universal Beam Grounding Clamp **PATENTED**

#### Type GUBC

- Fits on a wide range of standard (angled) and wide flange (parallel) structural steel beams providing a mounting pad suitable for a two-hole compression lug
- Installs quickly and easily with standard 0.25" key hex wrench tooling
- UL 467 Listed and CSA 22.2 Certified for grounding and bonding suitable for direct burial in earth or concrete
- Complies with vibration tests per MIL-STD-202G (METHOD 201A)

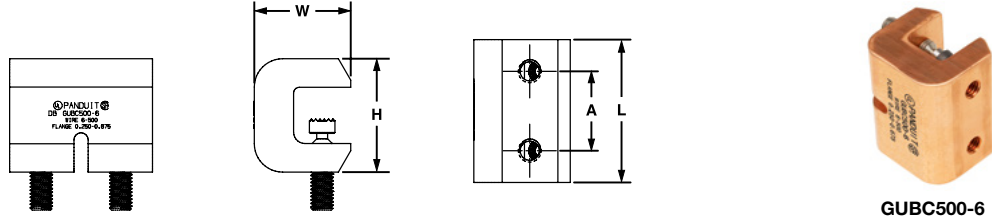

GUBC500-6

Part Number	Material	Copper Conductor Size Range AWG (mm <sup>2</sup> )	Flange Thickness In. (mm)	Thread Size In.	Hex Size	Figure Dimensions In. (mm)				Std. Pkg. Qty.
						A	L	W	H	
<b>BEST SELLER</b> GUBC500-6	Copper	#6 AWG – 500 kcmil (16 – 240)	0.250 – 0.675 (6.3 – 17.1)	0.5 – 13	0.25	1.75 (44.4)	3.15 (80.0)	2.13 (54.0)	2.50 (63.5)	1

### Code Conductor, Heavy Duty, CTAP

#### For Copper Code Connections Type CTAP

- Provide high-strength and premium electrical properties
- Suitable for use with solid and stranded copper Code conductors for tapping into unbroken continuous main, as a wire joint or two-way splice
- The wide wire range-taking capability minimizes inventory requirements
- UL listed and CSA certified to 600 V and temperature rated 90°C when crimped with Panduit and specified competitor crimping tools and dies

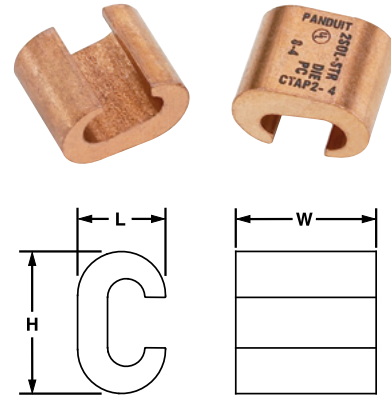

Part Number	Copper Conductor Size		Figure Dimensions In. (mm)			Panduit Die Index No.‡	Burndy Die Index No.‡	Wire Strip Length In. (mm)	Std. Pkg. Qty.
	AWG Run (mm <sup>2</sup> )	AWG Tap (mm <sup>2</sup> )	L	T	V				
<b>BEST SELLER</b> CTAP2/0-2-X	1/0 – 2/0 AWG STR	#8 – #2 AWG SOL or STR	0.80 (20.3)	0.93 (23.6)	1.32 (8.1)	PO	O	1 1/16 (27)	10
<b>BEST SELLER</b> CTAP4/0-2-X	3/0 – 4/0 AWG STR	#6 – #2 AWG SOL or STR	0.94 (23.9)	1.08 (27.4)	1.66 (42.2)	PD3	F	1.25 (32)	
<b>BEST SELLER</b> CTAP4/0-4/0-X		3/0 – 4/0 AWG STR	1.00 (25.4)		1.57 (39.9)			7/8 (22.2)	
CTAP2-2-X	#2 SOL OR STR	#2 SOL OR STR	0.60 (15.3)	0.75 (19.1)	1.05 (26.7)	PC	C	7/8 (22.2)	

\*\*Consult cable manufacturer for voltage stress relief instructions with applications greater than 2000 V

‡Visit [www.panduit.com](http://www.panduit.com) for tool and die information

^Note: CTAP parts are UL Listed and CSA Certified with AWG wire only

Not UL/CSA approved for use with metric wire. See GCE & GCC series parts for UL/CSA approved connections for metric wire



### Bronze Service Post Connectors, Male Stud, Single Conductor

- For grounding two copper code conductors to steel structures, busbars, or transformers or for tapping from busbar with hex nut and washer
- Made from high copper content, hard drawn copper rod provides high strength

- Pressure bar provides secure connection on a full range of conductor combinations used with each connector providing premium wire pull-out strength
- cULus 467 Listed for grounding and bonding and suitable for direct burial in earth or concrete

#### Type SP2 – Premium Grade

- True hex design for body and nut hex provides correct fit with socket, box, or open end wrenches for easy installation process

- Offered with standard and long stud lengths for optimized fit of the threaded stud through the mounting surface

Part Number	Conductor Size Range (AWG)	Stud Size (UNC Threads)	Figure Dimensions In.		Nut Hex In.	Body Hex In.	Std. Pkg. Qty.
			L	Z			
SP2-2-C	#10 STR – #2 STR	0.375 – 16	1.38	0.63	0.88	0.69	100
BEST SELLER SP2-2L-C			1.28	1.13			
SP2-2/0-Q	#2 SOL – 2/0 STR	0.5 – 13	1.88	0.75	1.13	0.88	25
BEST SELLER SP2-4/0-Q	#1 SOL – 4/0 STR	0.625 – 11	2.25	1.00	1.38	1.13	

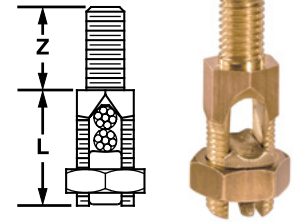

### Bronze Grounding Clamp with Spacer for Flat Surfaces

- Used to ground copper code conductor to flat surfaces
- Cast from high strength, electrolytic bronze to provide reliable grounding connections
- High strength silicone bronze hardware for long term reliable assembly
- Accommodates a wide range of conductor sizes – minimizes inventory requirement, saves cost

- Incorporates spacer plate to separate conductor from mounting surface
- cULus 467 Listed for grounding and bonding and suitable for direct burial in earth or concrete

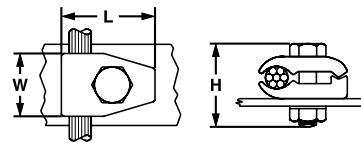

Part Number	Conductor Size Range (AWG)	Figure Dimensions In.			Hex Size In.		Std. Pkg. Qty.
		L	W	H	Bolt	Nut	
GM-3-Q	2/0 SOL – 250 kcmil	2.13 (54)	1.50 (38)	2.00 (51)	0.75	0.75	25



### Aluminum One-Hole Grounding Lay-In Lugs

- Used for quick installation of a continuous grounding conductor
- UL 467 Listed for grounding and bonding, copper lugs UL Listed for direct burial in earth or concrete

- UL Listed for use up to 600 V and temperature rated 90°C
- Wide wire range-taking capability minimizes inventory requirements

#### Tin-Plated Aluminum Body

Part Number	Set Screw Material	Conductor Size Range	Stud Hole Size In.	Hex Key Size In.	Length In.	Width In.	Height In.	Std. Pkg. Qty.
LIAS250-56-Q*	Zinc Plated Steel	#6 AWG – 250 kcmil	0.33	0.25	2.20	0.80	1.70	25
LIAC-22-C*	Steel	#14 SOL – #4 STR	0.22		1.06	0.39	0.78	100

\*Not DB Rated

The use of Panduit oxide inhibiting joint compound (CMP) is recommended for pad to conductor connections Refer to [www.panduit.com](http://www.panduit.com) for more information



# SAFETY SOLUTIONS

---

VeriSafe™ Absence of Voltage Testers .....	144-145
VeriSafe™ 2.0 Network Module.....	146
VeriSafe™ Insulation Piercing Connectors .....	146
Electrical Labels in Dispenser .....	147
Self-Laminating Safety Tag Carriers .....	147
Self-Laminating Fiber Optic Cable Marker Tags .....	147
Lockout Devices .....	148
Metal Group Lock Box.....	149
Lockout Kits.....	150
Non-Conductive Safety Padlocks .....	150
Underground Hazard Tape.....	150



### VeriSafe™ Absence of Voltage Testers Safer. Smarter. More Efficient.

- Test for absence of voltage with the push of a button
- Meet the NFPA 70E and CSA-Z462 best practice for testing for absence of voltage, enabling your facility to operate safer, smarter, and more efficiently



By automating this process, the VeriSafe™ Absence of Voltage Tester:

- Reduces the risk of exposure of electrical hazards for improved worker safety
- Reduces testing procedure time and complexity to improve productivity
- Supports compliance when used to verify the electrical lockout/tagout process as described in NFPA 70E

Voltage PRESENCE Indication		ABSENCE of Voltage Testing	
Red LEDs indicate hazardous voltage present	Lack of red LEDs does not guarantee voltage absence	Push to initiate test and see progress	Green indicates absence of voltage is confirmed

#### VeriSafe 1.0 Absence of Voltage Testers

Part Number	For Use With	Description	Std. Pkg. Qty.
<b>BEST SELLER</b> VS-AVT-C08-L10	3-Phase AC Systems, up to 600 V	Includes three-phase battery powered indicator module, 8 ft. (2.4m) system cable, and 10 ft. (3.0m) sensor leads	1
VS-AVT-C02-L03		Includes three-phase battery powered indicator module, 2 ft. (0.6m) system cable, and 3 ft. (0.9m) sensor leads	

### VeriSafe 2.0 Ordering Information

**Step 1 Select Configuration**    VS2-AVT - XYZ - ##    Example: **BEST SELLER** VS2-AVT-3PB-08

Choose your system	Choose your indicator	Choose your cable
<p><b>XY</b></p> <p><b>3P</b> 3-Phase 2.0 System 10' (3.0 m) Black Sensor Leads</p> <p><b>1P</b> DC/Single-Phase 2.0 System 10' (3.0 m) Black Sensor Leads</p>	<p><b>Z</b></p> <p><b>F</b> Battery Free Indicator</p> <p><b>B</b> Battery Powered Indicator (battery included)</p>	<p><b>##</b></p> <p><b>02</b> 2' (0.6m) System Cable</p> <p><b>08</b> 8' (2.4m) System Cable</p> <p><b>16</b> 16' (4.8m) System Cable</p>

### Absence of Voltage Testers



#### Which Technology Should I Use?

The next-generation VeriSafe Absence of Voltage Tester (AVT) has an enhanced set of features and will be compatible with additional applications. The 2.0 AVT uses new technology for the connectivity test and voltage threshold measurement, making it more robust for many applications.



#### VeriSafe 1.0 Absence of Voltage Testers

Feature	VeriSafe 1.0 AVT	VeriSafe 2.0 AVT
<b>Maximum Voltage</b> (nominal)	600 VAC (50/60Hz), 600 VDC	<b>1000 VAC (50/60Hz), 1000 VDC</b>

#### Overvoltage Category

CAT III	600 V	<b>1000 V</b>
CAT IV	300 V	<b>600 V</b>
<b>Voltage Presence Indicators</b> (Red LEDs)	AC only	<b>AC &amp; DC</b>
<b>Network Compatible</b>	No	<b>YES</b>
<b>Power for AVT Test</b> (Yellow and Green LEDs)	3.6 V Lithium Battery	<b>3.6 V Lithium Battery 12-24 VDC PoE*</b>
<b>Dedicated DC/Single-Phase SKUs</b>	No	<b>YES</b>
<b>Operating Temperature</b>	-25 – 60°C	<b>-25 – 60°C</b>

#### Indicator Module Options

Battery Powered (IP 66, 67, 69; Type 1, 12, 13, 4, 4X)	✓	✓
Battery Free (IP 66, 67, 69K; Type 1, 12, 13, 4, 4X)		✓
<b>Maximum Number of Indicator Modules</b>	1	<b>2</b>

#### Hazardous Locations

Class I Division 2 (gas)		✓
Class II Division 2 (dust)		✓
Class I, Zone 2, Zone 22 (US and CAN)		✓

#### Outputs

Absence of Voltage (Green LED – SIL 3)	✓	✓
Voltage Presence (Red LEDs)		✓
<b>Voltage Reporting</b>		<b>Measured Values*</b>

\*Requires 2.0 AVT Network Module (VS2-NET)

### VeriSafe™ Accessories

Part Number	Description	Std. Pkg. Qty.
<b>VS2-AVT-11B</b>	VeriSafe 2.0 AVT single-phase Battery Indicator Module	1
<b>VS2-AVT-11F</b>	VeriSafe 2.0 AVT single-phase Battery Free Indicator Module	
<b>VS2-AVT-31B</b>	VeriSafe 2.0 AVT three-phase Battery Indicator Module	
<b>VS2-AVT-31F</b>	VeriSafe 2.0 AVT three-phase Battery Free Indicator Module	
<b>VS2-CABLE-02</b>	VeriSafe 2.0 AVT Replacement Cable, 2ft (0.6m), for use with VeriSafe 2.0 AVTs only	
<b>VS2-CABLE-04</b>	VeriSafe 2.0 AVT Replacement Cable, 4ft (1.2m), for use with VeriSafe 2.0 AVTs only	
<b>VS2-CABLE-08</b>	VeriSafe 2.0 AVT Replacement Cable, 8ft (2.4m), for use with VeriSafe 2.0 AVTs only	
<b>VS2-CABLE-16</b>	VeriSafe 2.0 AVT Replacement Cable, 16ft (4.8m), for use with VeriSafe 2.0 AVTs only	
<b>VS2-CABLE-20</b>	VeriSafe 2.0 AVT Replacement Cable, 20ft (6.0m), for use with VeriSafe 2.0 AVTs only	
<b>VS2-CABLE-30*</b>	VeriSafe 2.0 AVT Replacement Cable, 30ft (9.1m), for use with VeriSafe 2.0 AVTs only	
<b>VS2-AVT-RL</b>	VeriSafe 2.0 Replacement Faceplate and Instruction labels in 8 languages. English, German, Mandarin, French Canadian, Italian, Korean, Spanish and French	



\*Longer lengths available up to 500ft, in 50 ft increments

### VeriSafe™ 2.0 Network Module

The VeriSafe Network Module provides a way to leverage data from a 2.0 Absence of Voltage Tester (AVT) for smarter system monitoring. Take troubleshooting to the next level by automatically measuring voltage and monitoring AVT results, without the need to open equipment doors and covers.



#### Smart Technology

- Keep doors and covers closed for monitoring and troubleshooting
- View AVT test results and data logs
- Use voltage and test data to trigger alerts in your control system

#### Flexible Integration

- Ethernet connectivity
- Solid state I/O contacts
- Custom Add on Profile for easy integration in Rockwell Automation Studio 5000, Automatic Diagnostics ready

Part Number	Description
<b>VS2-NET</b>	Network Module accessory, for use with VS2-AVT models

### VeriSafe™ Insulation Piercing Connection Kits

- Provide a fast, secure, and reliable way to terminate AVT sensor leads
- The compact connector design accommodates up to two taps in a single housing that fully insulates both connections
- The connector allows taps to be made without compromising the integrity of conductors and includes integrated strain relief
- Ideal for new and retrofit applications, connections can be made without modifying existing conductor runs

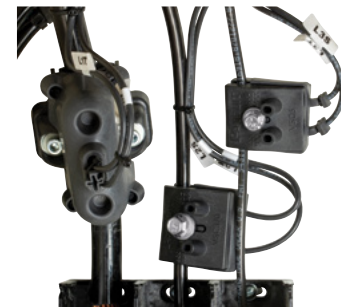

Part Number	Description
<b>VS-CKP14-6</b>	Insulation Piercing Connection Kit for tapping 14 to 6 AWG conductors. Rated for 600 V installations. Kit includes 3 connectors for installation of 1 AVT
<b>VS-CKP4-000</b>	Insulation Piercing Connection Kit for tapping 4 to 3/0 AWG conductors. Rated for 600 V installations. Kit includes 3 connectors for installation of 1 AVT
<b>VS-CKP1K4/0-500</b>	Insulation Piercing Connection Kit for tapping AWG 4/0 to 500MCM copper conductors. Rated for 1KV installations. Kit includes 3 connectors for installation of 1 AVT

Additional connection options and cable accessories can be found at [www.panduit.com/verisafe](http://www.panduit.com/verisafe)

### Electrical Label in Dispenser

- Indoor/outdoor rated
- Laminated label material protects legend from abrasion and chemicals
- Resistant to UV light, chemical atmosphere and abrasion
- Excellent life and adhesion properties

Part Number	Description	Diameter	Std. Pkg. Qty.
<b>PLD-57</b>	300 labels/dispenser	0.75"	1



### Self-Laminating Safety Tag Carriers

- Cut out paper to fit and insert into the self-laminating carrier allows tags to be resistant to mild chemicals and acids. Sturdy brass grommet provides extra durability
- Panduit PLT2S (7.40 inches) nylon ties included for quick and easy installation
- Meet OSHA Standard 1910.147 for lockout tag 50 lb. pull force requirement

Part Number	Lamination Style	Tag Size	Std. Pkg. Qty.
<b>PST-1</b>	Front only	3.00" x 2.00"	10



### Self-Laminating Fiber Optic Cable Marker Tags

- Rigid vinyl, self-laminating material
- Indoor/outdoor rated; high quality, rugged material resistant to abrasion; legend is protected by overlaminates; use where adhesives will not work
- Temperature range: 0°F to 176°F (-18°C to 80°C)

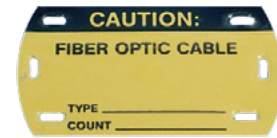

Part Number	Legend	Color (Legend/Background)	Width		Height		Tags per Pkg.	Std. Pkg. Qty.	Std. Ctn. Qty.
			In.	mm	In.	mm			
<b>BEST SELLER</b> <b>PST-FO</b>	CAUTION: FIBER OPTIC CABLE TYPE _____ COUNT _____	Black/Yellow	3.50	89.0	2.00	51.0	5	1	40
<b>PST-FOBLNK</b>	BLANK	Yellow							

Order number of packages required in multiples of Standard Package Quantity



**Like what you see and want more?**

Visit [www.panduit.com](http://www.panduit.com) for the full offering of Panduit products

### PowerLOK™ Circuit Breaker Lockout Device

- Provides a versatile, easy to use lockout/tagout device
- Can be applied to single or multi-pole circuit breakers (such as 120/277 V breakers) to prevent the breaker from being turned back on
- For safe performance of maintenance or service in accordance with lockout/tagout procedures
- Two metal contacts
- Fits single and multi-pole circuit breakers
- Two-position padlock design
- Two-piece construction



Part Number	Description	Std. Pkg. Qty.
<b>PSL-PCBNT</b>	PowerLOK™ “No Tool circuit” breaker lockout	1

### Miniature Circuit Breaker Lockout Devices

- Quickly locks out miniature circuit breakers commonly used in industrial automation and motor control
- On the PSL-MCBNT, multiple padlock orientations allow adjacent circuit breakers to be locked out individually
- PSL-MCBNT can be installed by hand with no tool required



Part Number	Description	Std. Pkg. Qty.
<b>PSL-MCBNT</b>	“No Tool” miniature circuit breaker lockout	1
<b>PSL-MCBNT-V</b>		5

### Universal & I-LINE™ Circuit Breaker Lockout Devices

- Quickly locks out circuit breakers (such as 120/277 V breakers); ideal for industrial and harsh applications
- PSL-CB can be installed using a screwdriver
- PSL-CBNT and PSL-CBILNT can be installed by hand, with no tool required

Part Number	Description	Std. Pkg. Qty.
<b>PSL-CB</b>	Universal circuit breaker lockout	1
<b>PSL-CBNT</b>	“No Tool” Universal circuit breaker lockout	
<b>PSL-CBNT-V</b>		5
<b>PSL-CBILNT</b>	“No Tool” circuit breaker lockout for use with Square D I-LINE™/ Federal Pacific (FPE) circuit breakers	1



**PSL-CBNT**



**PSL-CBILNT**

### Large Handle Circuit Breaker Lockout Device

- Quickly locks out large molded-case circuit breakers (such as 480/600 V breakers)
- Can be installed by hand, with no tool required

Part Number	Description	Std. Pkg. Qty.
<b>PSL-CBL</b>	Large handle circuit breaker lockout	1





### Lockout Hasps

These devices provide the ideal solution when procedures require multiple workers on locked-out equipment.

Workers can be assigned a padlock (sold separately) with shackle diameter up to 9/32" to attach to the hasp before starting their task. Ensure the energy source stays locked out – with multiple workers' padlocks in the holes of the closed hasp. Once each worker completes their task, they remove their padlock. The hasp cannot be removed until the last padlock is removed.

- Energy sources can be locked out quickly for more than one worker for group lockout applications
- Heavy duty hasps with tamper-resistant designs to deter vandalism
- Variety of lockout hasp styles and sizes to accommodate a wide range of lockout applications



Part Number	Description	Max. No. Locks	Std. Pkg. Qty.	Std. Ctn. Qty.
<b>BEST SELLER</b> PSL-MLD	Multiple lockout device; includes lockout hasp and 6.0' (1.8m) vinyl coated galvanized steel cable with loop/hole	6	1	20
PSL-MLDH-X	Multiple lockout device (hasp only)		10	—
PSL-1	Hasp with 1.00" (25.40mm) diameter jaw and overlapping tabs		12	144
PSL-1A	Hasp with 1.00" (25.40mm) diameter jaw			

### Toggle Switch Cover Device

- Compact secure design fits most toggle switches and some small circuit breakers
- Easily attached without removal of faceplate or screws
- Accommodates switches
  - 0.45 – 0.78 inches tall
  - 0.25 – 0.38 inches wide
  - 0.25 – 0.40 inches thick
- Constructed of rugged nylon and stainless steel providing strength, durability, added security and corrosion resistance

Part Number	Std. Pkg. Qty.
PSL-WS	1



### Corded AC Plug Cover Lockout Device

- Insert plugs, close cover, and secure with padlock and tag (sold separately)
- Individual corded plugs in a wide range of sizes can be locked out to prevent energization
- Constructed of rugged polypropylene providing strength, durability, and added security

Part Number	Description	Std. Pkg. Qty.	Std. Ctn. Qty.
PSL-CL480	Lockout fits 240 – 480 VAC corded plug, 3.25" x 3.25" x 6.50" inside dimensions	12	144



### Metal Group Lock Box

- Manage multiple employees and energy sources involved in a group lockout procedure
- Accommodates up to 13 padlocks (not included)
- Available in industrial powder-coated or stainless steel construction
- Dimensions: 9.00"W x 6.00"H x 3.25"D

Part Number	Description	Std. Pkg. Qty.
PSL-GLBN	Group Lock Box	1



### Electrician Lockout Kit

Part Number	Kit Contents	Std. Pkg. Qty.
<b>PSL-PK-EA</b>	(1) Screwdriver (1) PSL-8 padlock (1) PSL-MLD multiple lockout (1) PSL-WS wall switch lockout (1) PSL-CBNT "No Tool" circuit breaker lockout (1) PSL-P plug lockout (5) PVT-30 blocking tags (1) PSL-PK pouch	1



### Contractor Lockout Kit

Part Number	Kit Contents	Std. Pkg. Qty.
<b>PSL-KT-CONA</b>	(1) Screwdriver (6) PSL-8 padlocks (1) PSL-1A hasp (1) PSL-MLD lockout (3) PSL-WS wall switch lockout (3) PSL-CBNT "No Tool" circuit breaker lockout (3) PSL-P plug lockouts (1) carrying case – 5.0" x 3.5" x 11.0" (15 Tags) PVT-98 "EQUIPMENT LOCKED OUT BY..." safety tags	1



### Non-Conductive Safety Padlocks

Aluminum body and shackle with non-conductive vinyl cover delivers protection against electrical hazards for maximum safety, specifically in lockout/tagout applications. Padlock is available with the standard 1.77-inch body or 3-inch long body design that allows safety message to be displayed on the padlocks in two languages.

Part Number	Color	Body Height	Std. Pkg. Qty.
<b>PSL-8BL</b>	Black	1.77" (45.2mm)	1
<b>PSL-8BU</b>	Blue		
<b>PSL-8GR</b>	Green		
<b>PSL-8OR</b>	Orange		
<b>PSL-8</b>	Red		
<b>PSL-8YL</b>	Yellow		
<b>PSL-8PU</b>	Purple		



### Underground Hazard Tape

- Polyethylene (HTU, HTD) materials
- Temperature range: -30°F to 200°F (-34°C to 93°C)
- Detectible Laminated Aluminum (HTDU) materials temper
- Temperature range: -30°F to 220°F (-34°C to 104°C)
- Pre-Printed
- Indoor/outdoor rated
- Designed for direct burial
- Highly visible legend is protected from abrasion and chemicals
- Resistant to UV light, chemical atmosphere, and abrasion
- Will not biodegrade

Part Number	Legend	Color (Legend/Background)	Height		Length		Std. Pkg. Qty.
			In.	mm	In.	mm	
<b>HTDU6R-E</b>	CAUTION ELECTRIC LINE BURIED BELOW	Black/Red	6.00	152.00	1000.00	305.00	1



# STAINLESS STEEL

---

Pan-Steel® Self Locking Cable Ties-MLT Series .....	153
Pan-Steel® Stainless Steel Cable Ties-MLTFC Series .....	154
Pan-Steel® Stainless Steel Cable Ties-MLTC Series .....	154
PCS Custom Length Cushion Sleeve.....	155
Pan-Steel® Strapping-MS and MSC series .....	155
Stainless Steel Ties Mounts .....	156
Stainless Steel Push Mounts.....	156
Stainless Steel 2-Way Ties Mount .....	156
Cable Ties Installation Tools .....	157





## **Pan-Steel® Stainless Steel Cable Ties**

The ultimate in wire & cable bundling, fastening, identification and installation solutions for demanding indoor and outdoor environments.

Discover more at  
[www.panduit.com/stainless-steel-cable-ties](http://www.panduit.com/stainless-steel-cable-ties)



### Pan-Steel® Self-Locking Cable Ties – MLT Series

- Speeds up installation with a patented, wide entry self-locking head that eases band threading and insertion
- Unique locking ramp design and strengthening ribs allows the tie to lock into place at any length along the tie body with increased lock strength
- Fully rounded edges ensure worker and bundle safety



Part Number	Max Bundle Diameter		Length*		Min Loop Tensile Strength**		Min Bundle Diameter		Width		Thickness		Recommended Installation Tool***	Std. Pkg. Qty.	Std. Ctn. Qty.
	In.	mm	In.	mm	lbs	N	In.	mm	In.	mm	In.	mm			

#### AISI 304 Stainless Steel – For General Purpose

##### Standard Cross Section

<b>BEST SELLER</b> MLT1S-CP	1.0	25	5.0	127	200	890	0.50	12.7	0.18	4.6	0.010	0.25	GS4MT-E, HTMT, PPTMT, ST2MT	100	500
<b>BEST SELLER</b> MLT2S-CP	2.0	51	7.9	201											
<b>BEST SELLER</b> MLT2.7S-CP	2.7	69	10.2	259											
<b>BEST SELLER</b> MLT4S-CP	4.0	102	14.3	362											
<b>BEST SELLER</b> MLT6S-CP	6.0	152	20.5	521											
<b>BEST SELLER</b> MLT8S-CP	8.0	203	26.8	679											

##### Light-Heavy Cross Section

MLT4LH-LP	4.0	102	14.3	362	250	1112	0.50	12.7	0.25	6.4	0.010	0.25	GS4MT-E, HTMT, PPTMT, ST2MT	50	250
-----------	-----	-----	------	-----	-----	------	------	------	------	-----	-------	------	-----------------------------	----	-----

##### Heavy Cross Section

MLT2H-LP	2.0	51	7.9	201	450	200	0.50	12.7	0.31	7.9	0.010	0.25	GS4MT-E, ST2MT, HTMT, PPTMT, PBTMT	50	250
MLT2.7H-LP	2.7	69	10.2	259											
<b>BEST SELLER</b> MLT4H-LP	4.0	102	14.3	362											
<b>BEST SELLER</b> MLT6H-LP	6.0	152	20.5	521											
MLT8H-LP	8.0	203	26.8	679											
MLT10H-LP	10.0	254	33.0	838											

#### AISI 316 Stainless Steel – For Most Corrosive Environments

##### Standard Cross Section

MLT1S-CP316	1.0	25	5.0	127	200	890	0.50	12.7	0.18	4.6	0.010	0.25	GS4MT-E, HTMT, PPTMT, ST2MT	100	500
<b>BEST SELLER</b> MLT2S-CP316	2.0	51	7.9	201											
<b>BEST SELLER</b> MLT4S-CP316	4.0	102	14.3	362											
<b>BEST SELLER</b> MLT6S-CP316	6.0	152	20.5	521											

##### Heavy Cross Section

MLT2H-LP316	2.0	51	7.9	201	450	2000	0.50	12.7	0.31	7.9	0.010	0.25	GS4MT-E, HTMT, PBTMT, PPTMT, ST2MT	50	250
<b>BEST SELLER</b> MLT4H-LP316	4.0	102	14.3	362											
MLT6H-LP316	6.0	152	20.5	521											
MLT8H-LP316	8.0	203	26.8	679											

##### Super-Heavy Cross Section

MLT4SH-LP316	4.0	102	17.1	434	900	4005	1.00	25.4	0.63	15.9	0.015	0.38	RT2HT, RT2HTN, PBTMT	50	250
MLT6SH-LP316	6.0	152	23.4	594											

\*For other lengths, thicknesses and material grades available, contact Panduit Customer Service or refer to [www.panduit.com](http://www.panduit.com)

\*\*Per SAE Standard AS23190/3 (formerly MIL)

Product Showcase

Abrasion Protection

Cable Cleats

Cable Ties

Cable Tie Accessories

Cable Tie Tools

Identification Products

Power Connectors

Grounding Connectors

Safety Solutions

Stainless Steel Ties

Terminals

Wiring Duct

Part Number Index



### Pan-Steel® Stainless Steel Ties – MLTFC Series

- Speeds up installation with a unique self-locking head design that locks into place at any part of the tie body
- The 316 stainless steel is wrapped in UV-resistant, halogen-free, Polyester to promote worker safety and reliability in corrosive, high-vibration, temperature-extreme environments

- The Polyester coating is available in six color options and provides visual indication for easy identification in color-coding applications



Part Number	Max Bundle Diameter		Length*		Color	Min Loop Tensile Strength**		Width		Thickness^		Recommended Installation Tool***	Std. Pkg. Qty.	Std. Ctn. Qty.
	In.	mm	In.	mm		lbs	N	In.	mm	In.	mm			

#### Standard Cross Section

<b>MLTFC2S-CP316</b>	2.0	51	7.9	201	Black	100	445	0.18	4.6	0.010	0.25	GS4MT-E, ST2MT, HTMT, PPTMT	100	500
<b>MLTFC4S-CP316</b>	4.0	102	14.3	362										

#### Heavy Cross Section

<b>MLTFC2H-LP316</b>	2.0	51	7.9	201	Black	250	1112	0.31	7.9	0.010	0.25	GS4MT-E, ST2MT, HTMT, PPTMT, PBTMT	50	250
<b>MLTFC4H-LP316</b>	4.0	102	14.3	362										
<b>MLTFC6H-LP316</b>	6.0	152	20.5	521										
<b>MLTFC8H-LP316</b>	8.0	203	26.8	679										

#### Extra-Heavy Cross Section

<b>MLTFC4EH-LP316</b>	4.0	102	17.1	434	Black	300	1335	0.50	12.7	0.010	0.25	ST2MT, RT2HT, RT2HTN, PBTMT	50	250
-----------------------	-----	-----	------	-----	-------	-----	------	------	------	-------	------	-----------------------------	----	-----

#### Super-Heavy Cross Section

<b>MLTFC4SH-LP316</b>	4.0	102	17.1	434	Black	300	1335	0.50	12.7	0.010	0.25	RT2HT, RT2HTN, PBTMT	50	250
-----------------------	-----	-----	------	-----	-------	-----	------	------	------	-------	------	----------------------	----	-----

\*Other lengths available, contact Panduit Customer Service

^Base material less coating. ^^Minimum bundle diameter is 0.50" (12.7mm)

### Pan-Steel® Stainless Steel Ties – MLTC Series

- Speeds up installation with a unique self-locking head design that locks into any part of the tie body
- The Nylon 11 coating provides additional edge protection and prevents corrosion between dissimilar metals
- The 316 stainless steel is wrapped in UV-resistant, halogen-free, low-smoke Nylon to promote worker safety and reliability in corrosive environments



Part Number	Max Bundle Diameter		Length*		Min Loop Tensile Strength**		Min Bundle Diameter		Width		Thickness^		Recommended Installation Tool***	Std. Pkg. Qty.	Std. Ctn. Qty.
	In.	mm	In.	mm	lbs	N	In.	mm	In.	mm	In.	mm			

#### AISI 316 Stainless Steel – For Nylon 11 Selectively Coated Cable Ties

#### Heavy Cross Section

<b>MLTC2H-LP316</b>	2.0	51	7.9	201	250	1112	0.50	12.7	0.31	7.9	0.010	0.25	GS4MT-E, ST2MT, HTMT, PPTMT, PBTMT	50	250
<b>MLTC4H-LP316</b>	4.0	102	14.3	362											
<b>MLTC6H-LP316</b>	6.0	152	20.5	521											
<b>MLTC8H-LP316</b>	8.0	203	26.8	679											
<b>MLTC10H-LP316</b>	10.0	254	33.0	838											

\*Other lengths available, contact Panduit Customer Service

^Base material less coating

### PCS Custom-Length Cushion Sleeves

- Compatible with heavy or super-heavy cross section ties, custom length banding systems, or MS strapping, for use in harsh environments, and applications
- Can be used indoors or outdoors (excellent ultraviolet resistance, good resistance to petroleum, and many chemicals)



Part Number	Material	Used with Pan-Steel® Ties/Strapping	Width		Length		Std. Pkg. Qty. (reels)‡
			In.	mm	Ft.	m	
<b>BEST SELLER</b> PCSSH-B-CR*	Neoprene	MLT/EH/SH and MS Straps	0.91	23.1	100	30.5	1
<b>BEST SELLER</b> PCSLSH-B-CR	TPE	MLT/EH/SH and MS Straps	1.05	26.8			

\*Meets MIL-R-6855

‡Order in number of reels required

Pkg. -CR = 100 ft. (30.5m) reel

### Pan-Steel® Wave-Ty™ Stainless Steel Ties

- Patented wave-form spring maintains greater installed tension on non-resilient objects
- Tightly clamps on applications where other stainless steel ties will not function
- Retains tension on a solid bundle with minimal applied force
- Guarantees performance in critical applications
- Self-locking with low thread force



Part Number	Max Bundle Diameter		Length*		Min Loop Tensile Strength**		Min Bundle Diameter		Width		Thickness		Recommended Installation Tool***	Std. Pkg. Qty.	Std. Ctn. Qty.
	In.	mm	In.	mm	lbs.	N	In.	mm	In.	mm	In.	mm			

#### AISI 304 Stainless Steel – For Superior Grip on Rigid Bundles Heavy Cross Section

<b>MLT6WH-LP</b>	6.0	152	20.5	521	450	2000	2.0	51	0.31	7.9	0.010	0.25	GS4MT-E, HTMT, PPTMT, ST2MT	50	250
------------------	-----	-----	------	-----	-----	------	-----	----	------	-----	-------	------	-----------------------------	----	-----

#### AISI 316 Stainless Steel – For Superior Grip on Rigid Bundles Heavy Cross Section

<b>MLT4WH-TL316</b>	4.0	102	14.3	362	450	2000	2.0	51	0.31	7.9	0.010	0.25	GS4MT-E, HTMT, PPTMT, ST2MT	250	2500
---------------------	-----	-----	------	-----	-----	------	-----	----	------	-----	-------	------	-----------------------------	-----	------

\*For other lengths, thicknesses and material grades available, contact Panduit Customer Service or refer to [www.panduit.com](http://www.panduit.com)

\*\*Per SAE Standard AS23190/3 (formerly MIL)



### Like what you see and want more?

Visit [www.panduit.com/stainless-steel-cable-ties](http://www.panduit.com/stainless-steel-cable-ties) for full offering of Panduit Stainless Steel products

**cUL<sup>us</sup> LISTED Pan-Steel® Strapping - MS and MSC series**

- Ultimate solution for applications requiring retained tension
- Fold over buckle design doesn't require a hammer and is safer to install
- Available in 304 and 316 steel, coated with UV resistant, halogen free and low smoke nylon 11 to promote worker safety and reliability in corrosive environments
- Custom length strapping can be cut to desired length



	For use with	Max. Bundle Dia. (In.)	Max. Bundle Dia. (mm)	Overall Length (In.)	Overall Length (mm)	Overall Thickness (In.)	Overall Thickness (mm)	Overall Width (In.)	Overall Width (mm)	Strap Breaking Strength (N)	Strap Breaking Strength (lb)
--	--------------	------------------------	-----------------------	----------------------	---------------------	-------------------------	------------------------	---------------------	--------------------	-----------------------------	------------------------------

**304 Stainless Steel Strapping**

<b>MS10W50T15-L4</b>	BT2HT tool	10	254	37	940	0.015	0.38	0.5	12.7	2979	671
<b>MS8W50T15-L4</b>	BT2HT tool	8	203	30.7	780						

**304 Stainless Steel Custom Length Strapping**

<b>MSW50T15-CR4</b>	BT2HT tool and MSBW50-C4 buckle	—	—	1200	30500	0.015	0.38	0.5	12.7	2979	671
---------------------	---------------------------------	---	---	------	-------	-------	------	-----	------	------	-----

**316 Stainless Steel Custom Length Nylon 11 Coated Strapping**

<b>MSCNW38T15-QR6</b>	BT2HT tool and MSBW50-C6 buckle	—	—	984	24993	0.015	0.38	0.38	9.5	2229	502
-----------------------	---------------------------------	---	---	-----	-------	-------	------	------	-----	------	-----

\*For other lengths, thicknesses and material grades available, contact Panduit Customer Service



**Like what you see and want more?**

Visit [www.panduit.com/stainless-steel-cable-ties](http://www.panduit.com/stainless-steel-cable-ties) for full offering of Panduit Stainless Steel products

## Stainless Steel Tie Mounts

- Low profile
- One hole mounting
- For use with standard, light-heavy, and heavy cross section Pan-Steel® Ties as well as 0.38 inch (9.5mm) wide strapping
- 304 Stainless Steel

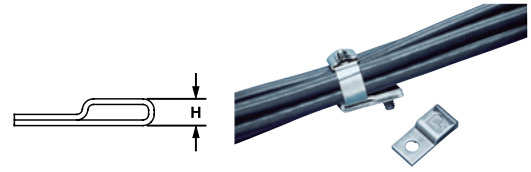
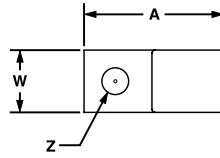

Part Number	Used with Pan-Steel® Ties/Strapping	Mounting Method*	Length A		Width W		Height H		Hole Diameter Z		Std. Pkg. Qty.	Std. Ctn. Qty.
			In.	mm	In.	mm	In.	mm	In.	mm		
<b>MTM1H10-C</b>	MLTS/LH/H, MLTC/H, MLTFC/S/H, or MSW38	#10 (5mm) screw	0.90	22.6	0.40	10.2	0.17	4.4	0.21	5.4	100	1000

\*Stainless steel screws are recommended for fastening to avoid corrosion problems associated with dissimilar metals. Contact Customer Service for additional sizes and material grades available.

## Stainless Steel Push Mounts

- No tapping required
- Used where only one side of the panel is accessible
- Nothing to assemble
- For use with standard, light-heavy, and heavy cross section Pan-Steel® Ties
- 304 Stainless Steel

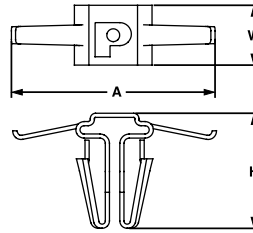

Part Number	Used with Pan-Steel® Ties/Strapping	Mounting Method	Length A		Width W		Height H		Panel Thickness		Std. Pkg. Qty.	Std. Ctn. Qty.
			In.	mm	In.	mm	In.	mm	In.	mm		
<b>MPWM-H56-Q</b>	MLTS/LH/H, MLTC/H, MLTFC/S/H	Inserted into pre-drilled hole 5/16" (8mm)	0.84	21.3	0.29	7.3	0.56	14.2	0.03 – 0.09	0.8 – 2.4	25	250

## Stainless Steel 2-Way Tie Mounts

- Allows stainless steel cable ties to be inserted from either of two sides
- Low profile
- Single hole center mounting for maximum holding and stability

- For use with standard, light-heavy, and heavy cross section Pan-Steel® Ties
- 304 Stainless Steel

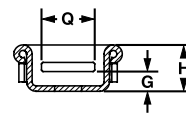
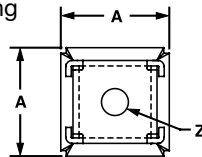

Part Number	Used with Pan-Steel® Ties/Strapping	Mounting Method*	Length A		Height H		Screw Head Height G		Slot Width Q		Hole Diameter Z		Std. Pkg. Qty.	Std. Ctn. Qty.
			In.	mm	In.	mm	lbs.	N	In.	mm	In.	mm		
<b>MTM2H-Q</b>	MLTS/LH/H, MLTC/H, MLTFC/S/H	#8 (4mm) screw	0.71	18.0	0.30	8.0	0.09	2.3	0.35	9.0	0.17	4.5	25	250

\*Stainless steel screws are recommended for fastening to avoid corrosion problems associated with dissimilar metals.

### Cable Tie Installation Tools

- Tools speed installation
- Feature high reliability, low maintenance, long life
- GS4MT-E and PBTMT feature automatic tension and cut-off capabilities for improved productivity and installer safety

Part Number	Description	Std. Pkg. Qty.
-------------	-------------	----------------

#### High Volume Use

<b>PBTMT</b>	Battery powered installation tool, for use with Pan-Steel® Heavy, Extra-Heavy, and Super-Heavy Cross Section MLT Style Ties, and MLTD Double Wrapped Style Ties, 2 – 12 volt lithium-ion batteries and 115 volt, 60 Hz charger included.	1
--------------	--	---

#### Medium Volume Use

<b>BEST SELLER</b> <b>GS4MT-E</b>	Used with standard, light-heavy, and heavy cross section Pan-Steel® type MLT ties, type MLTC/MLTFC coated ties, and type MLTDH double wrapped ties.	1
<b>BEST SELLER</b> <b>ST2MT</b>	Used with standard, light-heavy, heavy and extra-heavy cross section Pan-Steel® type MLT ties, standard and heavy cross section MLTC/MLTFC ties or extra heavy MLTDH double wrapped ties.	



GS4MT-E



ST2MT

### RT2HT Installation Tool

- Cable tie side entry for immediate positioning of tie and tool to speed installation
- Multi-position rear handle provides flexibility for a one or two hand installation
- Replacement cutter blade and handle available

Part Number	Part Description	Std. Pkg. Qty.
<b>RT2HT</b>	Used with extra-heavy, extra-heavy 15 and super-heavy cross section Pan-Steel® type MLT, Heat Trace Wave-Ty™ and MLTFC ties. Width of tool nose 2.60" (66.0mm).	1



### Like what you see and want more?

Visit [www.panduit.com/stainless-steel-cable-ties](http://www.panduit.com/stainless-steel-cable-ties) for full offering of Panduit Stainless Steel products



# TERMINALS

---

Ring Terminal, Nylon Insulated .....	161
Ring Terminal, Vinyl Insulated-Funnel Entry .....	162
Ring Terminal, Large Wire, Vinyl Insulated .....	163
Ring Terminal, Non-Insulated .....	164
Ring Terminal, Large Wire Non-Insulated.....	165
Fork Terminal, Nylon Insulated .....	165
Vinyl Insulated Fork Terminal.....	166
Locking Fork Terminal, Vinyl Insulated-Funnel Entry .....	166
Male/Female Coupler, Nylon Fully Insulated-Funnel Entry .....	167
Female Disconnect, Nylon Fully Insulated-Funnel Entry .....	167-168
Female Disconnect, Nylon Barrel Insulated-Funnel Entry .....	168
Female Disconnect, Vinyl Barrel Insulated .....	168-169
Right Angle Female Disconnect, Nylon Insulated-Funnel Entry.....	169
Pin Terminal, Vinyl Insulated-Funnel Entry .....	170
Butt Splice, Nylon Insulated.....	170
Butt Splice, Vinyl Insulated.....	171
Parallel Splice, Non-Insulated.....	171
Wire Joint, Nylon Insulated.....	172
Heat Shrink, Butt Splices .....	172
Insulated Ferrules-Single Wire DIN End Sleeve .....	173-174
Insulated Ferrules-Twin Wire DIN End Sleeve.....	174
Insulated Ferrules on Strips-Single Wire .....	175
Ferrules, Non-Insulated.....	175
Ferrule Assortment Kits .....	175
Ring Terminals, Nylon Insulated--Non-Funnel and Funnel Entry.....	176
Ring Terminals, Vinyl Insulated-Funnel Entry .....	177
Locking Fork Terminals, Nylon Insulated-Funnel Entry .....	178
Locking Fork Terminals, Vinyl Insulated-Funnel Entry .....	178
Female Disconnects-Nylon Fully Insulated.....	178
Disco™ Female Disconnects, Vinyl Barrel Insulated .....	179-180
Disco™ Male Disconnects, Nylon Fully Insulated .....	181
Butt Splices Nylon Insulated.....	181
Insulated Ferrules on Reels .....	182

---

# Terminals

Panduit terminals are designed and manufactured for fast assembly and reliable performance. Panduit provides an extensive line of tooling designed specifically to provide optimum performance.

Discover the full line of Terminals at [www.panduit.com/wire-termination](http://www.panduit.com/wire-termination)

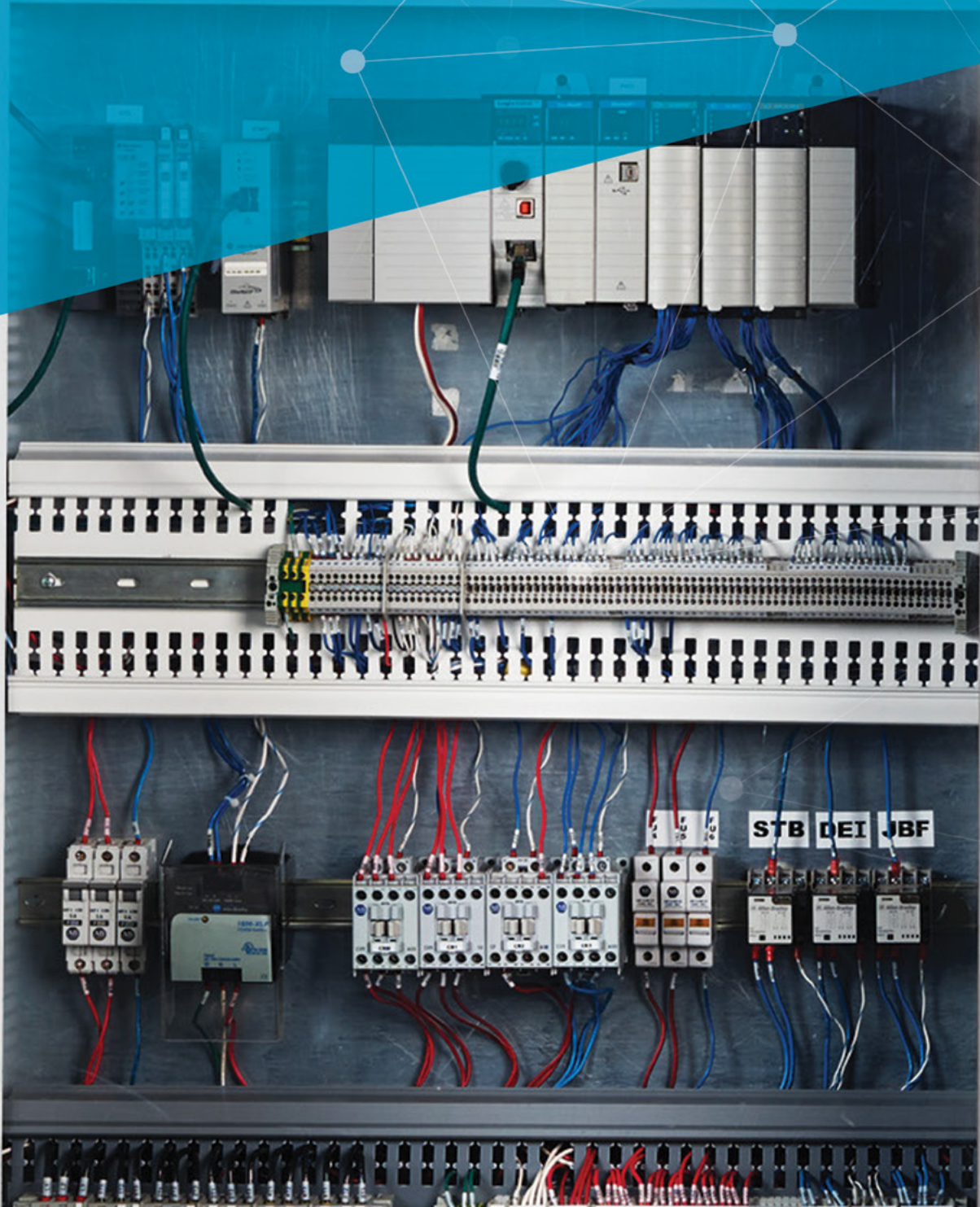





## Ring Terminals, Nylon Insulated

### Type PN-R

- Ring tongue design assures a secure connection in high vibration applications
- The metal insulation grip sleeve crimps to wire insulation, providing protection and strain relief to the crimp joint for high vibration applications
- Internal barrel serrations assure good wire contact and maximum tensile strength
- UL Flammability UL 94 HB, maximum insulation temperature 221°F (105°C)
- UL and CSA rated up to 600 V per UL 486A/B

Part Number	Wire Range	Color Code	Stock Thickness In.	Max Ins. In.	Stud Size	Figure Dimensions In.			Recommended Installation Tool	Std. Pkg. Qty.**	Std. Ctn. Qty.
						L	W	C			
PN18-6R-C	22 – 18 AWG	Red	0.03	0.145	#6	0.80	0.25	0.22	CT-100‡, CT-1550‡, CT-1551‡, CT-2300/ST‡, CT-2500/L‡, UP14ZLW‡	100	500
PN18-8R-C					#8	0.86					
PN18-10R-C					#10	0.88					
PN14-6R-C	18 – 14 AWG	Blue		0.162	#6		0.31	0.25	CT-100‡, CT-1550‡, CT-1551‡, CT-2300/ST‡, CT-2500/L‡, UP14ZLW‡		
PN14-8R-C					#8	0.85					
PN14-10R-C					#10						
PN14-14R-C			1/4"	1.05	0.46	0.38					
PN10-8R-L	12 – 10 AWG	Yellow	0.04	0.225	#8	1.06	0.37	0.31	CT-100‡, CT-1550‡, CT-1551‡, CT-2300/ST‡, CT-2500/L‡, UP14ZLW‡	50	
<b>BEST SELLER</b> PN10-10R-L					#10		0.38				
PN10-14R-L					1/4"	1.21	0.52	0.38			
PN10-38R-L					3/8"	1.29	0.58	0.43			

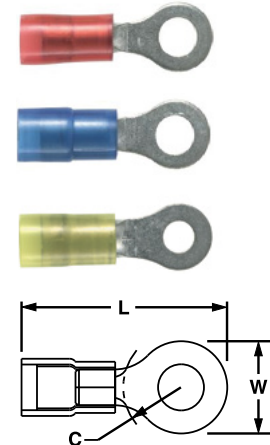

\*\*Bulk and/or convenience packaging may be available, contact Panduit® Customer Service for additional information ‡UL and CSA approved tooling/product combinations. For crimping tool information see [www.panduit.com](http://www.panduit.com)



**Like what you see and want more?**

Visit [www.panduit.com](http://www.panduit.com) for the full offering of Panduit products



### Ring Terminals, Vinyl Insulated – Funnel Entry

#### Type PV-R

- Insulation support helps to prevent wire damage in bending applications
- Ring tongue design assures a secure connection in high vibration applications
- Brazed seam protects terminal barrel from splitting during the crimp process
- Internal barrel serrations assure good wire contact and maximum tensile strength
- UL Flammability UL 94V-0, maximum insulation temperature 221°F (105°C)
- UL and CSA rated up 600 V per UL 486A/B

Part Number	Wire Range	Color Code	Stock Thickness In.	Max Ins. In.	Stud Size	Figure Dimensions In.			Recommended Installation Tool	Std. Pkg. Qty.**	Std. Ctn. Qty.
						L	W	C			
PV18-6R-CY	22 – 18 AWG	Red	0.03	0.150	#6	0.86	0.25	0.22	CT-100‡, CT-1550‡, CT-1551‡, CT-2300/ST‡, CT-2500/L‡, UP14ZLW‡	100	500
PV18-8R-CY					#8	0.91		0.26			
PV18-10R-CY					#10	0.94		0.27			
PV14-6R-C	16 – 14 AWG	Blue	0.03	0.170	#6		0.31	CT-100‡, CT-1550‡, CT-1551‡, CT-2300/ST‡, CT-2500/L‡, UP14ZLW‡	500		
PV14-8R-C					#8	0.92				0.25	
PV14-10R-C					#10						
PV14-14R-C					1/4"	1.12	0.46			0.38	
PV10-8R-L	12 – 10 AWG	Yellow	0.04	0.225	#8	1.05	0.31	0.31	CT-100‡, CT-1550‡, CT-1551‡, CT-2300/ST‡, CT-2500/L‡, UP14ZLW‡	50	
<b>BEST SELLER</b> PV10-10R-L					#10						
PV10-14R-L					1/4"	1.23	0.52	0.38			
PV10-56R-L					5/16"						
PV10-38R-L					3/8"						1.31

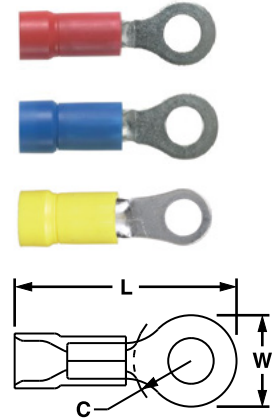

\*\*Bulk and/or convenience packaging may be available, contact Panduit® Customer Service for additional information  
‡UL and CSA approved tooling/product combinations. For crimping tool information see [www.panduit.com](http://www.panduit.com)



### Like what you see and want more?

Visit [www.panduit.com](http://www.panduit.com) for the full offering of Panduit products



### Ring Terminals, Large Wire, Vinyl Insulated

#### Type PV-R

- Ring tongue design assures a secure connection in high vibration applications
- Insulation support helps to prevent wire damage in bending applications
- Brazed seam protects terminal barrel from splitting during the crimp process
- Internal barrel serrations assure good wire contact and maximum tensile strength
- UL Flammability UL 94V-0, maximum insulation temperature 221°F (105°C)
- UL rated up to 600 V per UL 486A/B

Part Number	Wire Range	Color Code	Stock Thickness In.	Max Ins. In.	Stud Size	Figure Dimensions In.			Recommended Installation Tool	Std. Pkg. Qty.**	Std. Ctn. Qty.
						L	W	C			
PV8-10R-QY	8 AWG	Red	0.04	0.280	#10	1.53	0.47	0.43	CT-2600/LBT, CD-2600-PV8‡	25	250
PV8-14R-QY					1/4"						
PV6-14R-X	6 AWG	Blue	0.05	0.340	1/4"	1.65		0.48	CT-2600/LBT, CD-2600-PV6‡	10	100

\*\*Bulk packaging may be available, contact Panduit® Customer Service for additional information  
 ‡UL approved tooling/product combinations. For crimping tool information see [www.panduit.com](http://www.panduit.com)

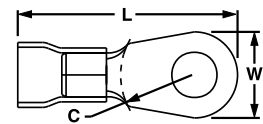
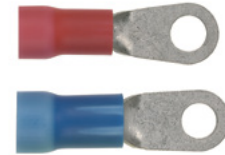

### Ring Terminal, Large Wire, Vinyl Expanded Insulation

#### Type PV-RX

- Ring tongue design assures a secure connection in high vibration applications
- Expanded wire entry designed to accommodate wire with a larger insulation thickness
- Insulation support helps to prevent wire damage in bending applications
- Brazed seam protects terminal barrel from splitting during the crimp process
- Internal barrel serrations assure good wire contact and maximum tensile strength
- UL Flammability UL 94V-0, maximum insulation temperature 221°F (105°C)
- UL rated up to 600 V per UL 486A/B

Part Number	Wire Range	Color Code	Stock Thickness (n.)	Max Ins. In.	Stud Size	Figure Dimensions In.			Recommended Installation Tool	Std. Pkg. Qty.**	Std. Ctn. Qty.
						L	W	C			
PV6-14RX-X	6 AWG	Blue	0.05	0.436	1/4"	1.61	0.47	0.51	CT-2600/LBT, CD-2600-PV6‡	20	200

\*\*Bulk packaging may be available, contact Panduit® Customer Service for additional information  
 ‡UL approved tooling/product combinations. For crimping tool information see [www.panduit.com](http://www.panduit.com)

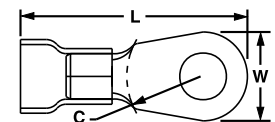





### Ring Terminals, Non-Insulated

#### Type P-R

- Ring tongue design assures a secure connection in high vibration applications
- Internal barrel serrations assure good wire contact and maximum tensile strength
- Brazed seam protects terminal barrel from splitting during the crimp process
- Barrel of terminal internally beveled to provide quick and easy wire insertion
- Maximum recommended operating temperature 302°F (150°C)
- UL and CSA rated up to 2000 V per UL 486A/B

Part Number	Wire Range	Stock Thickness In.	Stud Size	Figure Dimensions In.			Recommended Installation Tool	Std. Pkg. Qty.**	Std. Ctn. Qty.
				L	W	C			
<b>P14-10R-C</b>	18 – 14 AWG	0.03	#10	0.71	0.31	0.25	CT-100‡, CT-200‡, CT-1570‡, CT-2300/ST‡, CT-2500/L‡, UP14ZLW‡	100	1000
<b>P14-14R-C</b>			1/4"	0.91	0.46	0.38			
<b>P10-10R-L</b>	14 – 10 AWG	0.04	#10	0.81	0.38	0.31	CT-100‡, CT-200‡, CT-1570‡, CT-1701‡, CT-2300/ST‡, CT-2500/L‡, UP14ZLW‡	50	500
<b>P10-14R-L</b>			1/4"	0.96	0.52	0.38			

\*\*Bulk packaging may be available, contact Panduit® Customer Service for additional information  
‡UL and CSA approved tooling/product combinations. For crimping tool information see [www.panduit.com](http://www.panduit.com)

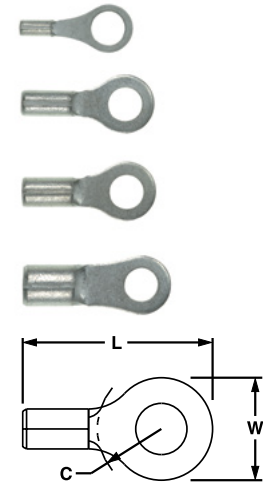

### Ring Terminal, Non-Insulated – High Temperature

#### Type P-RHT

- Ring tongue design assures a secure connection in high vibration applications
- Nickel plated copper for temperatures up to 650°F (343°C)
- Internal barrel serrations assure good wire contact and maximum tensile strength
- Brazed seam protects terminal barrel from splitting during the crimp process
- Barrel of terminal internally beveled to provide quick and easy wire insertion
- Rated up to 2000 V

Part Number	Wire Range	Stock Thickness In.	Stud Size	Figure Dimensions In.			Recommended Installation Tool	Std. Pkg. Qty.**	Std. Ctn. Qty.
				L	W	C			
<b>P10-10RHT6-L</b>	12 – 10 AWG	0.04	#10	0.81	0.38	0.33	CT-100, CT-200, CT-1570, CT-1701, CT-2300/ST, CT-2500/L, UP14ZLW	50	500

\*\*Bulk packaging may be available, contact Panduit® Customer Service for additional information

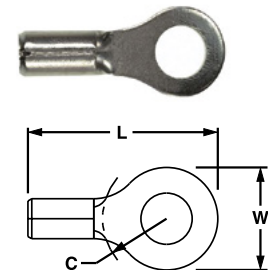



## Ring Terminals, Large Wire Non-Insulated

### Type P-R

- Designed for use with #8 - #2 AWG copper wire
- Ring tongue design assures a secure connection in high vibration applications
- Internal barrel serrations assure good wire contact and maximum tensile strength
- Brazed seam protects terminal barrel from splitting during the crimp process
- Barrel of terminal internally beveled to provide quick and easy wire insertion
- Maximum recommended operating temperature 302°F (150°C)
- UL and CSA rated up to 2000 V per UL 486A/B

Part Number	Wire Range	Stock Thickness In.	Stud Size	Figure Dimensions In.			Recommended Installation Tool	Std. Pkg. Qty.**	Std. Ctn. Qty.
				L	W	C			
P8-14R-Q	8 AWG	0.04	1/4"	1.14	0.47	0.43	CT-2600/LBT‡, CT-1701‡	25	250
P6-14R-E	6 AWG	0.05		1.21			CT-1701‡, CT-2600/LBT‡, CD-2600-P8‡, CD-2600-P6‡	20	200

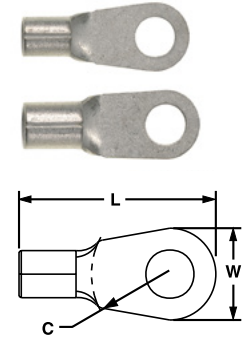

\*\*Bulk packaging may be available, contact Panduit Customer Service for additional information  
 ‡UL and CSA approved tooling/product combinations. For crimping tool information see [www.panduit.com](http://www.panduit.com)



## Fork Terminals, Nylon Insulated

### Type PN-F

- Fork design provides for fast and easy installation, without the need to remove fastener
- Metal insulation grip sleeve crimps to wire insulation, providing protection to the crimp joint during high vibration applications
- Internal barrel serrations assure good wire contact and maximum tensile strength
- UL Flammability UL 94 HB, maximum insulation temperature 221°F (105°C)
- UL and CSA rated up to 600 V per UL 486A/B

Part Number	Wire Range	Color Code	Stock Thickness In.	Max Ins. In.	Stud Size	Figure Dimensions In.			Recommended Installation Tool	Std. Pkg. Qty.**	Std. Ctn. Qty.	
						L	W	C				
PN18-8F-C	22 - 18 AWG	Red	0.03	0.145	#8	0.85	0.32	0.23	CT-100‡, CT-1550‡, CT-1551‡, CT-2300/ST‡, CT-2500/L‡, UP14ZLW‡	100	500	
PN14-6F-C	18 - 14 AWG	Blue				#6	0.79	0.28	0.19			CT-100‡, CT-1550‡, CT-1551‡, CT-2300/ST‡, CT-2500/L‡, UP14ZLW‡
PN14-8F-C						#8	0.85	0.31	0.23			
PN14-10F-C	12 - 10 AWG	Yellow	0.04	0.225	#8	#10	0.87	0.34	0.24	CT-100‡, CT-1550‡, CT-1551‡, CT-2300/ST‡, CT-2500/L‡, UP14ZLW‡	50	
PN10-8F-L						#8	1.03	0.37	0.22			
PN10-10F-L	#10	1.04	0.37	0.22								

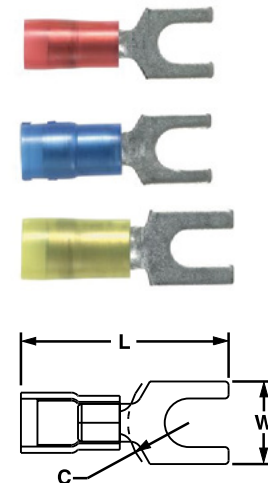

\*\*Bulk and/or convenience packaging may be available, contact Panduit® Customer Service for additional information  
 ‡UL Listed, cULus Listed, and CSA approved tooling/product combinations.  
 For crimping tool information see [www.panduit.com](http://www.panduit.com)

- Product Showcase
- Abrasion Protection
- Cable Cleats
- Cable Ties
- Cable Tie Accessories
- Cable Tie Tools
- Identification Products
- Power Connectors
- Grounding Connectors
- Safety Solutions
- Stainless Steel Ties
- Terminals
- Wiring Duct
- Part Number Index



### Vinyl Insulated Fork Terminals

#### Type PV-F

- Fork design provides for fast and easy installation, without the need to remove fastener
- Brazed seam protects terminal barrel from splitting during the crimp process
- Internal barrel serrations assure good wire contact and maximum tensile strength.
- Barrel insulation provides protection and strain relief when crimped
- UL Flammability UL 94V-0, maximum insulation temperature 221°F (105°C)
- UL and CSA rated up to 600 V per UL 486A/B

Part Number	Wire Range	Color Code	Stock Thickness In.	Max Ins. In.	Stud Size	Figure Dimensions In.			Recommended Installation Tool	Std. Pkg. Qty.**	Std. Ctn. Qty.
						L	W	C			
PV18-6F-CY	22 – 16 AWG	Red	0.03	0.150	#6	0.86	0.30	0.21	CT-100‡, CT-1550‡, CT-1551‡, CT-2300/ST‡, CT-2500/L‡, UP14ZLW‡	100	500
PV18-8F-CY					#8	0.93	0.32	0.25			
PV18-10F-CY					#10	0.93	0.35				
PV14-6F-C	16 – 14 AWG	Blue	0.03	0.170	#6	0.84	0.28	0.19	CT-100‡, CT-1550‡, CT-1551‡, CT-2300/ST‡, CT-2500/L‡, UP14ZLW‡	100	500
PV14-8F-C					#8	0.90	0.31	0.23			
PV14-10F-C					#10	0.92	0.34	0.24			
PV10-6F-L	14 – 10 AWG	Yellow	0.04	0.225	#6	1.01	0.31	0.25	CT-100‡, CT-1550‡, CT-1551‡, CT-2300/ST‡, CT-2500/L‡, UP14ZLW‡	50	500
PV10-8F-L					#8	1.04	0.37				
PV10-10F-L					#10	1.04	0.37				

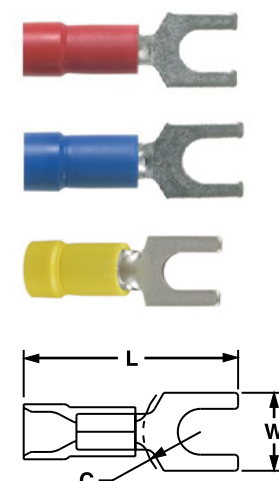

BEST SELLER

\*\*Bulk and/or convenience packaging may be available, contact Panduit Customer Service for additional information ‡UL Listed, cULus Listed, and CSA approved tooling/product combinations. For crimping tool information see [www.panduit.com](http://www.panduit.com)



### Locking Fork Terminals, Vinyl Insulated – Funnel Entry

#### Type PV-LF

- Locks in place for secure connection
- Fork design provides for fast and easy installation, without the need to remove fastener
- Insulation support helps to prevent wire damage in bending applications
- Internal barrel serrations assure good wire contact and maximum tensile strength
- UL Flammability UL 94V-0, maximum insulation temperature 221°F (105°C)
- UL and CSA rated up to 600 V per UL 486A/B

Part Number	Wire Range	Color Code	Stock Thickness In.	Max. Ins. In.	Stud Size	Figure Dimensions In.			Recommended Installation Tool	Std. Pkg. Qty.**	Std. Ctn. Qty.
						L	W	C			
PV14-6LF-C	18 – 14 AWG	Blue	0.03	0.170	#6	0.90	0.25	0.22	CT-100‡, CT-1550‡, CT-1551‡, CT-2300/ST‡, CT-2500/L‡, UP14ZLW‡	100	500
PV14-8LF-C					#8	0.97	0.29	0.25			
PV10-8LF-L	12 – 10 AWG	Yellow	0.04	0.225	#8	1.05	0.30	0.23	CT-100‡, CT-1550‡, CT-1551‡, CT-2300/ST‡, CT-2500/L‡, UP14ZLW‡	50	500
PV10-10LF-L					#10	1.04	0.34				

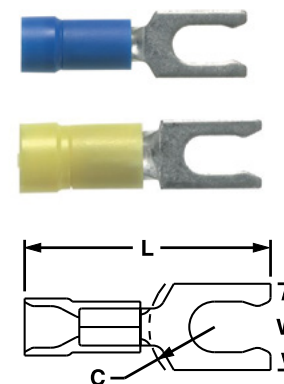

\*\*Bulk and/or convenience packaging may be available, contact Panduit Customer Service for additional information ‡UL and CSA approved tooling/product combinations. For crimping tool information see [www.panduit.com](http://www.panduit.com)



## Male/Female Couplers, Nylon Fully Insulated – Funnel Entry

### Type DNF

- Disconnect can be inserted and removed from the male tab without the use of tools for lower installed cost
- Fully insulated design provides protection from electrical shorts
- Internal barrel serrations assure good wire contact and maximum tensile strength
- Internal wire stop assures proper length of insertion into terminal barrel, providing a higher quality connection
- Coupler, male, and female parts sold separately
- UL Flammability UL 94 HB, maximum insulation temperature 221°F (105°C)
- UL and CSA rated up to 600 V per UL 310

Part Number	Wire Range	Color Code	Max. Ins. In.	Figure Dimensions In.			Tab Size In.	Recommended Installation Tool	Std. Pkg. Qty.**	Std. Ctn. Qty.
				L	W	C				
<b>DNF18-250FIM-L Male</b>	22 – 18 AWG	Red	0.133	0.90	0.42	0.27	0.250 x 0.032	CT-100‡, CT-1525‡, CT-2300/ST, CT-2500/L, UP14ZLW	50	250
<b>DNF18-250FIB-C Female</b>										
<b>DNF14-250FIM-L Male</b>	16 – 14 AWG	Blue	0.158	0.90	0.42	0.27		CT-1525‡, CT-2300/ST, CT-2500/L, UP14ZLW	50	250
<b>DNF14-250FIB-C Female</b>										

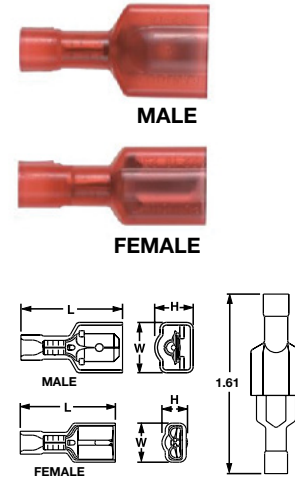

\*\*Bulk packaging may be available, contact Panduit® Customer Service for additional information  
‡UL and CSA approved tooling/product combinations. For crimping tool information see [www.panduit.com](http://www.panduit.com)



## Female Disconnects, Nylon Fully Insulated – Funnel Entry

### Type DNF-FIB

- Disconnect can be inserted and removed from the male tab without the use of tools for lower installed cost
- Fully insulated design provides protection from electrical shorts
- Internal wire stop assures proper length of insertion into terminal barrel, providing a higher quality connection
- UL Flammability UL 94 HB, maximum insulation temperature 221°F (105°C)
- UL and CSA rated up to 600 V per UL 310

Part Number	Wire Range	Color Code	Max. Ins. In.	Figure Dimensions In.			Tab Size In.	Recommended Installation Tool	Std. Pkg. Qty.**	Std. Ctn. Qty.
				L	W	C				
<b>DNF18-110FIB-C</b>	22 – 18 AWG	Red	0.120	0.71	0.19	0.16	0.110 x 0.032	CT-100‡, CT-1525‡, CT-2300/ST, CT-2500/L, UP14ZLW	100	1000
<b>DNF10-250FIB-L</b>	12 – 10 AWG	Yellow	0.220	0.96	0.35	0.23	0.250 x 0.032	CT-1525‡, CT-2300/ST, CT-2500/L	50	500

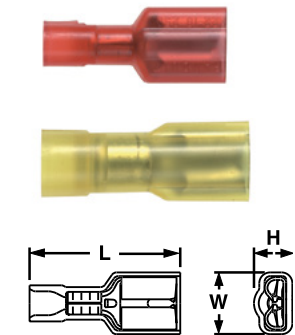

\*\*Bulk packaging may be available, contact Panduit® Customer Service for additional information  
‡UL and CSA approved tooling/product combinations. For crimping tool information see [www.panduit.com](http://www.panduit.com)

- Product Showcase
- Abrasion Protection
- Cable Cleats
- Cable Ties
- Cable Tie Accessories
- Cable Tie Tools
- Identification Products
- Power Connectors
- Grounding Connectors
- Safety Solutions
- Stainless Steel Ties
- Terminals
- Wiring Duct
- Part Number Index



### Female Disconnect, Nylon Fully Insulated – Funnel Entry, Metal Collar

#### Type DNF-FI

- Disconnect can be inserted and removed from the male tab without the use of tools for lower installed cost
- Fully insulated design provides protection from electrical shorts
- Internal wire stop assures proper length of insertion into terminal barrel, providing a higher quality connection
- Barrel design with larger outside diameter for use with more common hand tools
- UL Flammability UL 94 HB, maximum insulation temperature 221°F (105°C)
- UL and CSA rated up to 600 V per UL 310

Part Number	Wire Range	Color Code	Max. Ins. In.	Figure Dimensions In.			Tab Size In.	Recommended Installation Tool	Std. Pkg. Qty.**	Std. Ctn. Qty.
				L	W	C				
<b>DNF10-250FI-L</b>	12 – 10 AWG	Yellow	0.220	0.95	0.36	0.27	0.250 x 0.032	CT-100‡, CT-1550‡, CT-1551‡, CT-2300/ST, CT-2500/L, UP14ZLW‡	50	500

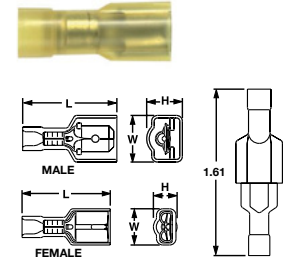

\*\*Bulk packaging may be available, contact Panduit Customer Service for additional information  
 ‡UL and CSA approved tooling/product combinations. For crimping tool information see [www.panduit.com](http://www.panduit.com)



### Female Disconnects, Nylon Barrel Insulated – Funnel Entry

#### Type DNF

- Disconnect can be inserted and removed from the male tab without the use of tools for lower installed cost
- Metal insulation grip sleeve crimps to wire insulation, providing protection to the crimp joint during high vibration applications
- Internal barrel serrations assure good wire contact and maximum tensile strength
- Internal wire stop assures proper length of insertion into terminal barrel, providing a higher quality connection
- UL Flammability UL 94 HB, maximum insulation temperature 194°F (90°C)
- UL and CSA rated up to 300 V per UL 310

Part Number	Wire Range	Color Code	Max. Ins. In.	Figure Dimensions In.			Tab Size In.	Recommended Installation Tool	Std. Pkg. Qty.**	Std. Ctn. Qty.
				L	W	C				
<b>DNF18-250-C</b>	22 – 18 AWG	Red	0.138	0.81	0.29	0.12	0.250 x 0.032	CT-1550, CT-1551, CT-2300/ST, CT-2500/L, UP14ZLW‡	100	500
<b>DNF14-250-C</b>	16 – 14 AWG	Blue	0.162	0.83						

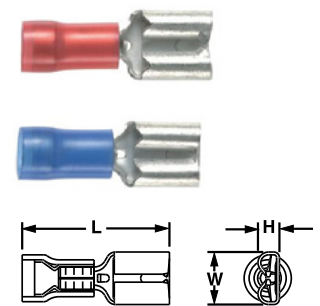

\*\*Bulk packaging may be available, contact Panduit® Customer Service for additional information  
 ‡UL and CSA approved tooling/product combinations. For crimping tool information see [www.panduit.com](http://www.panduit.com)





## Female Disconnects, Vinyl Barrel Insulated

### Type DV-B

- Disconnect can be inserted and removed from the male tab without the use of tools for lower installed cost
- Internal barrel serrations assure good wire contact and maximum tensile strength
- Internal wire stop assures proper length of insertion into terminal barrel, providing a higher quality connection
- UL Flammability UL 94V-0, maximum insulation temperature 221°F (105°C)
- UL and CSA rated up to 600 V per UL 310

Part Number	Wire Range	Color Code	Max Ins. In.	Figure Dimensions In.			Tab Size In.	Recommended Installation Tool	Std. Pkg. Qty.**	Std. Ctn. Qty.
				L	W	C				
DV14-250B-C ▲	16 – 14 AWG	Blue	0.170	0.81	0.29	0.12	0.250 x 0.032	CT-1525 <sup>^</sup> , CT-2300/ST, CT-2500/L	100	500
DV10-250-L* ▲	12 – 10 AWG	Yellow	0.229	1.03	0.30	0.13		CT-1550 <sup>^</sup> , CT-1551 <sup>^</sup> , CT-2300/ST, CT-2500/L, UP14ZLW	50	

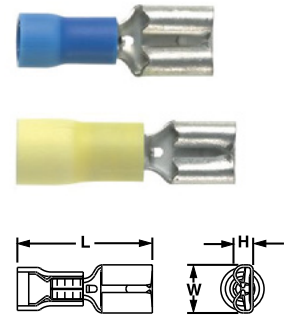

\*Sleeved barrel, maximum insulation temperature 194°F (90°C)

\*\*Bulk packaging may be available, contact Panduit Customer Service for additional information

‡UL and CSA approved tooling/product combinations. For crimping tool information see [www.panduit.com](http://www.panduit.com)

<sup>^</sup>CSA approved tooling/product combinations

▲UL Recognized only



## Right Angle Female Disconnect, Nylon Insulated – Funnel Entry

### Type DNFR-B

- Right angle design for use in limited space applications
- Disconnect can be inserted and removed from the male tab without the use of tools for lower installed cost
- Longer barrel design for use with Panduit® standard disconnect tool
- UL Flammability UL 94 HB, maximum insulation temperature 221°F (105°C)
- UL and CSA rated up to 600 V per UL 310

Part Number	Wire Range	Color Code	Max Ins. In.	Figure Dimensions In.				Tab Size In.	Recommended Installation Tool	Std. Pkg. Qty.	Std. Ctn. Qty.
				L	W	H	D				
DNFR14-250B-L	16 – 14 AWG	Blue	0.155	0.78	0.36	0.20	0.63	0.250 x 0.032	CT-1525 <sup>‡</sup> , CT-2300/ST, CT-2500/L	50	500

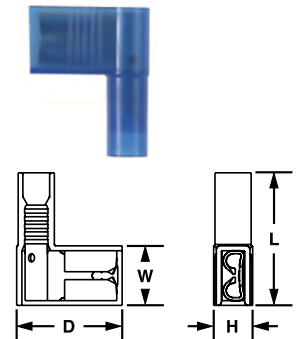

\*\*Bulk packaging may be available, contact Panduit® Customer Service for additional information

‡UL and CSA approved tooling/product combinations. For crimping tool information see [www.panduit.com](http://www.panduit.com)

### Pin Terminals, Vinyl Insulated – Funnel Entry

#### Type PV-P

- Solid pin designed to prevent damage to the wire from over tightening, resulting in a reliable electrical connection
- Insulation support helps to prevent wire damage in bending applications
- Brazed seam protects terminal barrel from splitting during the crimp process
- Internal barrel serrations assure good wire contact and maximum tensile strength
- For use with pin-type terminal blocks
- UL Flammability UL 94V-0, maximum insulation temperature 221°F (105°C)
- UL rated up to 600 V per UL 486A/B

Part Number	Wire Range	Color Code	Max Ins. In.	Figure Dimension In.			Recommended Installation Tool	Std. Pkg. Qty.**	Std. Ctn. Qty.
				L	W	P			
PV18-P47-CY	22 – 18 AWG	Red	0.150	0.97	0.07	0.49	CT-100, CT-260, CT-1550, CT-1551, CT-2300/ST, CT-2500/L	100	1000
PV14-P47-C	16 – 14 AWG	Blue	0.170						

\*\*Bulk packaging may be available, contact Panduit® Customer Service for additional information

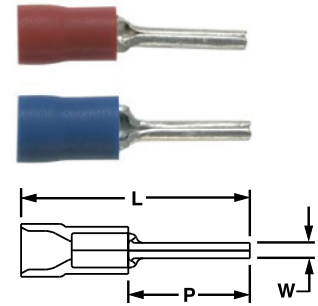

### Butt Splices, Nylon Insulated

#### Type BSN

- Designed to splice two solid or stranded wires together to repair or lengthen wires
- Butted configuration provides low profile for limited space applications
- Brazed seam protects terminal barrel from splitting during the crimp process
- Internal wire stop assures proper length of insertion into terminal barrel
- UL Flammability UL 94 HB, maximum insulation temperature 221°F (105°C)
- UL and CSA rated up to 600 V per UL 486C

Part Number	Wire Range	Color Code	Max Ins. In.	Figure Dimensions In.	Recommended Installation Tool	Std. Pkg. Qty.**	Std. Ctn. Qty.
				L			
BSN22-C*	26 – 22 AWG	Yellow	0.080	0.79	CT-1525, CT-2300/ST, CT-2500/L	100	1000
BSN18-C	22 – 18 AWG	Red	0.115	1.15	CT-100, CT-1550, CT-1551, CT-2300/ST, CT-2500/L, UP14ZLW		
<b>BEST SELLER</b> BSN14-C	16 – 14 AWG	Blue	0.148		CT-100, CT-1550, CT-1551, CT-2300/ST, CT-2500/L, UP14ZLW		
BSN10-L	12 – 10 AWG	Yellow	0.210	1.14	CT-100, CT-1550, CT-1551, CT-2300/ST, CT-2500/L, UP14ZLW	50	500

\*Not UL or CSA Listed

\*\*Bulk packaging may be available, contact Panduit® Customer Service for additional information

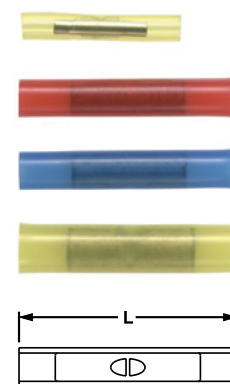



### Butt Splices, Vinyl Insulated

#### Type BSV

- Expanded wire entry designed to accommodate wire with a larger insulation thickness
- Designed to splice two solid or stranded wires together to repair or lengthen wires
- Brazed seam protects terminal barrel from splitting during the crimp process
- Internal wire stop assures proper length of insertion into terminal barrel
- UL Flammability UL 94V-0, maximum insulation temperature 221°F (105°C)
- UL and CSA rated up to 600 V per UL 486C

Part Number	Wire Range	Color Code	Max Ins. In.	Figure Dimensions In.	Recommended Installation Tool	Std. Pkg. Qty.**	Std. Ctn. Qty.
				L			
BSV18X-LY	22 – 18 AWG	Red	0.170	1.03	CT-100, CT-1550, CT-1551, CT-2300/ST, CT-2500/L, UP14ZLW	50	500
BSV14X-L	16 – 14 AWG	Blue	0.200	1.04			
BSV10X-Q	12 – 10 AWG	Yellow	0.250	1.18		25	250

\*\*Bulk packaging may be available, contact Panduit Customer Service for additional information

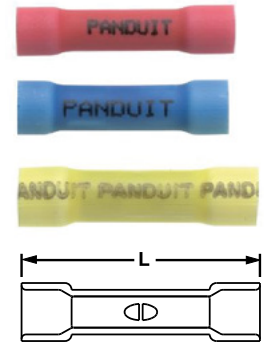

### Parallel Splice, Non-Insulated

#### Type PS

- Designed to splice two solid or stranded wires together to repair or lengthen wires
- Parallel design results in only one crimp required to complete splice
- Seamless tubular barrel provides a consistent high performance quality crimp
- Non-insulated barrel can be used to provide an economical termination when insulation is not required
- Maximum recommended operating temperature 302°F (150°C)
- UL and CSA rated up to 2000 V per UL 486C

Part Number	Wire Range	Figure Dimensions In.	Wire Strip Length In.	Recommended Installation Tool	Std. Pkg. Qty.**	Std. Ctn. Qty.
		L				
PS12-L	14 – 12 AWG	0.38	7/16	CT-100, CT-200	50	500

\*\*Bulk packaging may be available, contact Panduit® Customer Service for additional information

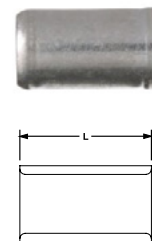

**Like what you see and want more?**

Visit [www.panduit.com](http://www.panduit.com) for the full offering of Panduit products



### Wire Joints, Nylon Insulated

#### Type JN

- Large barrel, designed to accommodate from one to seven wires with just one crimp
- Accommodates multiple wire sizes in varying combinations
- Barrel of terminal internally beveled to provide quick and easy wire insertion
- UL Flammability UL 94 HB, maximum insulation temperature 221°F (105°C)
- UL and CSA rated up to 600 V per UL 486C

Part Number	Wire Range	Color Code	CMA Range		Figure Dimensions In.	Wire Strip Length In.	Recommended Installation Tool	Std. Pkg. Qty.**	Std. Ctn. Qty.
			Min	Max	L				
JN218-216-C	(2) #22 – (2) #16	Clear	1284	5160	0.78	7/16	CT-1550‡, CT-1551‡, CT-2300/ST, CT-2500/L	100	1000
JN418-212-C	(4) #18 – (2) #12		6480	14750	0.93	1/2	CT-100‡, CT-1550‡, CT-1551‡, CT-2300/ST, CT-2500/L		
JN314-412-C*	(3) #14 – (4) #12		10320	26120	0.97	5/8	CT-100, CT-260		

\*Not UL or CSA Listed

\*\*Bulk packaging may be available, contact Panduit Customer Service for additional information

‡UL and CSA approved tooling/product combinations. For crimping tool information see [www.panduit.com](http://www.panduit.com)

Note: Wire combinations using #24 AWG wire are not UL Listed or CSA Certified



### Heat Shrink, Butt Splices

#### Type BSH

- Designed to splice two stranded wires together to repair or lengthen wires
- Butted configuration provides low profile for limited space applications
- Heat shrink polyolefin sleeve with hot melt adhesive protects against moisture
- After crimping, heat shrink insulation is completed with a standard heat gun
- Minimum continuous operating temperature -65°F (-55°C)
- Maximum continuous operation temperature 230°F (110°C)
- Shrink temperature 300°F (150°C)
- UL and CSA rated up to 600 V per UL 486C

Part Number	Wire Range	Color Code	Max Ins. In.	Figure Dimensions In.	Wire Strip Length In.	Recommended Installation Tool	Std. Pkg. Qty.**	Std. Ctn. Qty.
				L				
BSH18-Q	22 – 18 AWG	Red	0.170	1.45	5/16	CT-310	25	125
BSH14-Q	16 – 14 AWG	Blue	0.190					
BSH10-E	12 – 10 AWG	Yellow	0.240	1.64			20	100

\*\*Bulk packaging may be available, contact Panduit Customer Service for additional information

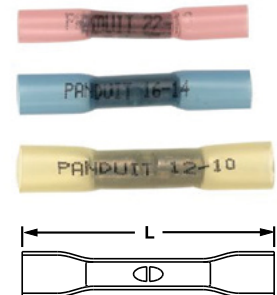



## Insulated Ferrules – Single Wire DIN End Sleeve

### Type FSD

- Polypropylene insulation housing conforms to DIN color requirements
- Meets DIN standards for single wire containment
- Funnel entry for faster insertion and lower installed cost
- Designed with a seamless barrel to contain loose wire strands for superior terminations
- Eases insertion of wire into terminal block

- Suitable for limited space panel applications
- Multiple pin lengths available for a variety of terminal blocks

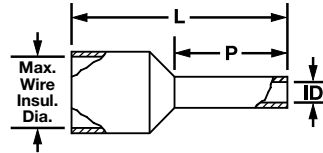

Part Number	Wire Size		Color Code	Max. Wire Insul. Dia.		Figure Dimensions						Wire Strip Length		Recommended Installation Tool	Std. Pkg. Qty.
	AWG	mm <sup>2</sup>		In.	mm	L		P		ID		In.	mm		
FSD73-8-D <sup>†</sup>	24 AWG	0.25	Yellow	0.07	2.0	0.49	12.5	0.31	8.0	0.03	0.8	15/32	11.9	CT-1002, CT-1123, CT-2523CH	500
FSD74-8-D <sup>†</sup>	24-22 AWG	0.34	Turquoise			0.53	13.5								
FSD75-8-D*	22-20 AWG	0.5	White	0.09	2.5	0.61	15.5	0.39	10.0	0.05	1.3	15/32	11.9	CT-1090, CT-1002, CT-1003, CT-1123, CT-1160, CT-1170, CD-090***, CT-2523CH	
FSD75-10-D*				0.11	2.8	0.63	16.0	0.39	10.0	0.06	1.5				
FSD76-8-D	18 AWG	0.75	Gray	0.11	2.8	0.49	12.5	0.24	6.0	0.06	1.5	3/8	9.5	CT-1090, CT-1002, CT-1003, CT-1123, CT-1160, CT-1170, CD-090***, CT-2523CH	
FSD76-10-D						0.65	16.5	0.39	10.0			17/32	13.5		
FSD77-6-D	—	1.0	Red	0.12	3.0	0.73	18.5	0.47	12.0	0.07	1.8	5/8	15.9	CT-1090, CT-1002, CT-1003, CT-1123, CT-1160, CT-1170, CD-090***, CT-2523CH	
FSD77-10-D						0.57	14.5	0.31	8.0			15/32	11.9		
FSD77-12-D						0.65	16.5	0.39	10.0			17/32	13.5		
FSD78-8-D	16 AWG	1.5	Black	0.12	3.0	0.73	18.5	0.47	12.0	0.09	2.3	5/8	15.9	CT-1090, CT-1002, CT-1003, CT-1123, CT-1160, CT-1170, CD-090***, CT-2523CH	
FSD78-10-D						0.59	15.0	0.31	8.0			15/32	11.9		
FSD78-12-D						0.75	19.0	0.47	12.0			5/8	15.9		
FSD80-8-D	14 AWG	2.5	Blue	0.17	4.2	0.69	17.5	0.39	10.0	0.11	2.9	17/32	13.5	CT-1090, CT-1002, CT-1003, CT-1123, CT-1160, CT-1170, CD-090***, CT-2523CH	
FSD80-12-D						0.75	19.0	0.47	12.0			5/8	15.9		
FSD81-10-D	12 AWG	4.0	Gray	0.19	4.8	0.79	20.0	0.47	12.0	0.14	3.6	5/8	15.9	CT-1090, CT-1002, CT-1123, CT-1003‡, CT-1160, CT-1170, CD-090***, CT-2523CH	
FSD81-12-C						0.79	20.0	0.47	12.0			5/8	15.9		
FSD82-12-C	10 AWG	6.0	Yellow	0.24	6.2									100	

† Tool/part not a UL listed combination. For crimping tool information see [www.panduit.com](http://www.panduit.com)  
 \*\*\*Dies used CT-2300 series Tool

(continued on next page)

- Product Showcase
- Abrasion Protection
- Cable Cleats
- Cable Ties
- Cable Tie Accessories
- Cable Tie Tools
- Identification Products
- Power Connectors
- Grounding Connectors
- Safety Solutions
- Stainless Steel Ties
- Terminals
- Wiring Duct
- Part Number Index





### Insulated Ferrules – Single Wire DIN End Sleeve (continued)

Part Number	Wire Size		Color Code	Max Wire Insul. Dia.		Figure Dimensions						Wire Strip Length		Recommended Installation Tool	Std. Pkg. Qty.
	AWG	mm <sup>2</sup>		In.	mm	L		P		ID		In.	mm		
				In.	mm	In.	mm	In.	mm	In.	mm	In.	mm		
<b>FSD83-12-C</b>	8 AWG	10.0	Red	0.30	7.5	0.83	21.0	0.47	12.0	0.18	4.6	5/8	15.9	CT-1003+, CT-1004+, CT-1123, CT-1104, CT-1160, CT-1170, CD-090***, CT-1090, CT-2504CH, CT-2523CH	100



### Insulated Ferrules – Twin Wire DIN End Sleeve

#### Type FTD

- Meet DIN standards for twin wire containment
- Polypropylene insulation housing conforms to DIN color requirements
- Funnel entry for faster insertion and lower installed cost
- Designed with a seamless barrel to contain loose wire strands for superior terminations
- Eases insertion of wire into terminal block

- Suitable for limited space panel applications
- Multiple pin lengths available for a variety of terminal blocks

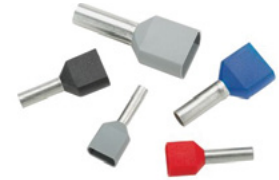
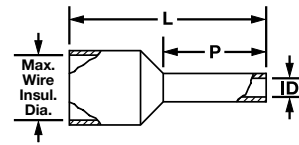

Part Number	Wire Size		Color Code	Max. Wire Insul. Dia.		Figure Dimensions						Wire Strip Length		Recommended Installation Tool	Std. Pkg. Qty.
	AWG	mm <sup>2</sup>		In.	mm	L		P		ID		In.	mm		
				In.	mm	In.	mm	In.	mm	In.	mm	In.	mm		
<b>FTD75-8-D*</b>	22-20 AWG	0.5	White	0.87	2.2	0.59	15.0	0.31	8.0	0.06	1.5	7/16	11.2	CD-090**, CT-1002, CT-1003 +, CT-1090, CT-1160, CT-1170, CT-1123, CT-2523CH***	500
<b>FTD77-8-D</b>	—	1.0	Red	0.11	2.7	0.67	17.0	0.39	10.0	0.08	2.1				
<b>FTD77-10-D</b>						0.63	16.0	0.31	8.0	0.09	2.3	7/16	11.2		
<b>FTD78-8-D</b>	16 AWG	1.5	Black	0.12	3.0	0.79	20.0	0.47	12.0	0.11	2.9	21/32	16.8		
<b>FTD78-12-D</b>						0.73	18.5	0.39	10.0			9/16	14.0		
<b>FTD80-10-TL</b>	14 AWG	2.5	Blue	0.15	3.7	0.85	21.5	0.51	13.0	0.11	2.9	23/32	18.2		
<b>FTD80-13-TL</b>						0.91	23.0	0.47	12.0			0.15	3.8	21/32	16.8
<b>FTD81-12-C</b>	12 AWG	4.0	Gray	0.17	4.3	0.91	23.0	0.47	12.0	0.15	3.8	21/32	16.8	CD-090**, CT-1002, CT-1003+, CT-1090, CT-1160, CT-1170, CT-1123, CT-2523CH***	100
<b>FTD82-14-C</b>	10 AWG	6.0	Yellow	0.19	4.8	0.98	25.0	0.55	14.0	0.18	4.6	3/4	19.0		

\*UL listed with 20 AWG only, UL486F scope is 1/0-20AWG. White is DIN color for 20 AWG

+Tool/part is not a UL listed combination

For crimping tool information see [www.panduit.com](http://www.panduit.com)

\*\*For use with CT-2300/ST or CT-2500CH crimp head

\*\*\*Crimp head for use with CT-2500/L tool



## Insulated Ferrules on Strips – Single Wire

### Type FSD

- Polypropylene insulation housing available in DIN standard colors in strips of 50
- Continuously molded design provides consistent placement of ferrules in tool to ensure fast, reliable terminations
- Available in #20 – 14 AWG featuring a seamless barrel design to contain loose wire strands for superior terminations

- Designed for use with the Semiautomatic Ferrule Crimping Tool CT-1000 for medium volume applications

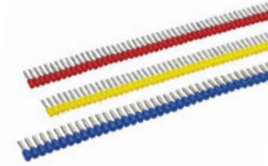
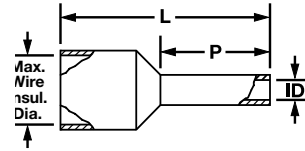

### DIN End Sleeves

Part Number	Wire Size		Color Code	Max. Wire Insul. Dia.		Figure Dimensions						Wire Strip Length		Recommended Installation Tool	Std. Pkg. Qty.
	AWG	mm <sup>2</sup>		In.	mm	L		P		ID		In.	mm		
FSD78-8-DSLO	16 AWG	1.50	Black	0.13	3.2	0.60	15.2	0.31	8.0	0.09	2.3	13/32	10.0	CT-1000	500



## Ferrules, Non-Insulated

### Type F

- Designed with a seamless barrel to contain loose wire strands for superior terminations
- Eases insertion of wire into terminal block
- Meets DIN standards for wire containment
- Suitable for limited space panel applications
- Multiple pin lengths available for a variety of terminal blocks

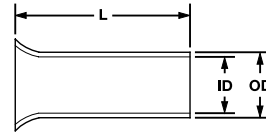

Part Number	Wire Size		Figure Dimensions						Wire Strip Length		Recommended Installation Tool	Std. Pkg. Qty.
	AWG	mm <sup>2</sup>	L		ID		OD		In.	mm		
F83-12-D	8 AWG	10.0	0.47	12.0	0.18	4.5	0.19	4.9	15/32	12.0	CD-090**, CT-1003+, CT-1004+, CT-1090, CT-1104, CT-1123, CT-1160, CT-1170, CT-2504CH***, CT-2523CH***	500
F86-25-C	2 AWG	35.0	0.98	25.0	0.33	8.3	0.34	8.7	31/32	25.0	CT-1005	100
F89-25-L*	2/0	70.0			0.49	12.5	0.52	13.3			CD-920-F89^^, CD-2001-F89^^^	50

\*Not UL listed, UL486F scope is 20 - 1/0 AWG only  
 \*\*For use with CT-2300/ST or CT-2500CH crimp head  
 \*\*\*Crimp head for use with CT-2500/L tool  
 ^^Dies compatible for use with CT-3001/STBT, CT-3001/CCPBT, CT-930LPCH tools  
 ^^Dies compatible for use with CT-2001 and CT-3001 tools

## Ferrule Assortment Kit

- Large selection of ferrules in a convenient compact case
- Plastic case is both durable and reusable keeping ferrules organized and separated

Part Number	Description	Std. Pkg. Qty.
KP-FSD2	Ferrule kit includes: #22 – 14 AWG insulated DIN ferrules. Case includes: 100 pieces each of FSD76-8, FSD77-8, FSD78-8 50 pieces each of FSD75-8 and FSD80-8	1

Ferrule kits do not include crimping tool



Product Showcase

Abrasion Protection

Cable Cleats

Cable Ties

Cable Tie Accessories

Cable Tie Tools

Identification Products

Power Connectors

Grounding Connectors

Safety Solutions

Stainless Steel Ties

Terminals

Wiring Duct

Part Number Index



### Ring Terminals, Nylon Insulated – Non-Funnel Entry

#### Type PN-R

- Continuously molded design provides reliable, consistent performance through the applicator for a high quality termination every time
- Ring tongue design assures a secure connection in high vibration applications
- Metal insulation grip sleeve crimps to wire insulation, providing protection to the crimp joint during high vibration applications
- Internal barrel serrations assure good wire contact and maximum tensile strength
- UL Flammability UL 94 HB, maximum insulation temperature 221°F (105°C)
- UL and CSA rated up to 600 V per UL 486A/B

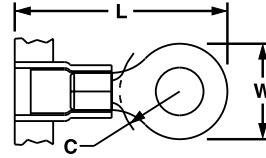

Part Number	Wire Range	Color Code	Stock Thickness In.	Max Ins. In.	Stud Size	Figure Dimensions In.			CA9 Series Crimp Die	CA-800/EZ Series Crimp Die	Pieces Per Reel
						L	W	C			
PN18-10R-3K	22 – 18 AWG	Red	0.03	0.145	#10	0.86	0.31	0.25	CD9-1A	CD-800-1	3000
PN14-10R-3K	16 – 14 AWG	Blue		0.162					CD9-2A	CD-800-2	



### Ring Terminals, Nylon Insulated – Funnel Entry

#### Type PNF-R

- Continuously molded design provides reliable, consistent performance through the applicator for a high quality termination every time
- Ring tongue design assures a secure connection in high vibration applications
- Metal insulation grip sleeve crimps to wire insulation, providing protection to the crimp joint during high vibration applications
- Internal barrel serrations assure good wire contact and maximum tensile strength
- UL Flammability UL 94 HB, maximum insulation temperature 221°F (105°C)
- UL and CSA rated up to 600 V per UL 486A/B

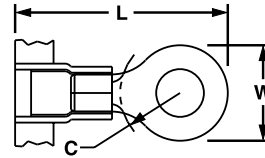

Part Number	Wire Range	Color Code	Stock Thickness In.	Max Ins. In.	Stud Size	Figure Dimensions In.			CA9 Series Crimp Die	CA-800/EZ Series Crimp Die	Pieces Per Reel
						L	W	C			
PNF18-10R-3K	22 – 18 AWG	Red	0.03	0.145	#10	0.86	0.31	0.25	CD9-1A	CD-800-1	3000
PNF14-10R-3K	16 – 14 AWG	Blue		0.162		0.85		0.29	CD9-2A	CD-800-2	
PNF10-10R-2K	12 – 10 AWG	Yellow	0.04	0.225		1/4"	1.06	0.38	0.31	CD9-3B	CD-800-3
PNF10-14R-2K					1.21	0.52	0.38				



**Like what you see and want more?**

Visit [www.panduit.com](http://www.panduit.com) for the full offering of Panduit products



## Ring Terminals, Vinyl Insulated – Funnel Entry

### Type PV-RB

- Continuously molded design provides reliable, consistent performance through the applicator for a high quality termination every time
- Ring tongue design assures a secure connection in high vibration applications
- Insulation support helps to prevent wire damage in bending applications
- UL Flammability UL 94V-0, maximum insulation temperature 221°F (105°C)
- UL and CSA rated up to 600 V per UL 486A/B

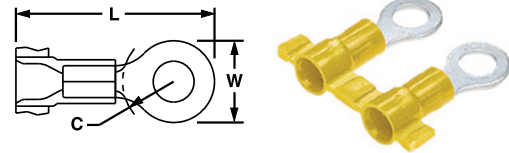

Part Number	Wire Range	Color Code	Stock Thickness In.	Max Ins. In.	Stud Size	Figure Dimensions In.			CA9 Series Crimp Die	CA-800/EZ Series Crimp Die	Pieces Per Reel
						L	W	C			
PV18-6RB-3K	22 – 18 AWG	Red	0.03	0.150	#6	0.78	0.25	0.20	CD9-1A	CD-800-1	3000
PV18-8RB-3K					#8	0.86	0.31	0.25			
PV18-10RB-3K					#10	1.06	0.45	0.38			
PV18-14RB-3K					1/4"	1.15	0.53	0.43			
PV18-38RB-2K					3/8"	1.15	0.53	0.43			
PV14-8RB-3K	16 – 14 AWG	Blue	0.170	0.170	#8	0.86	0.31	0.25	CD9-2A	CD-800-2	3000
PV14-10RB-3K					#10	1.05	0.45	0.38			
PV14-14RB-3K					1/4"	1.06	0.46	0.38			
PV14-56RB-2K					5/16"	1.06	0.46	0.38			
PV10-8RB-2K	12 – 10 AWG	Yellow	0.04	0.225	#8	1.02	0.31	0.31	CD9-3B	CD-800-3	2000
<b>BEST SELLER</b> PV10-10RB-2K					#10	1.20	0.52	0.38			
PV10-14RB-2K					1/4"	1.20	0.52	0.38			
PV10-56RB-2K					5/16"	1.23	0.58	0.43			
PV10-38RB-2K					3/8"	1.23	0.58	0.43			



## Locking Fork Terminal, Nylon Insulated – Funnel Entry

### Type PNF-LF

- Continuously molded design provides reliable, consistent performance through the applicator for a high quality termination every time
- Snap in place for secure connection
- Fork design provides for fast and easy installation, without the need to remove fastener
- Metal insulation grip sleeve crimps to wire insulation, providing protection to the crimp joint during high vibration applications
- Internal barrel serrations assure good wire contact and maximum tensile strength
- UL Flammability UL 94 HB, maximum insulation temperature 221°F (105°C)
- UL and CSA rated up to 600 V per UL 486A/B

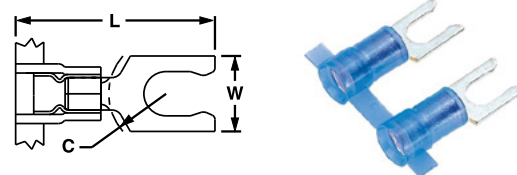

Part Number	Wire Range	Color Code	Stock Thickness In.	Max Ins. In.	Stud Size	Figure Dimensions In.			CA9 Series Crimp Die	CA-800/EZ Series Crimp Die	Pieces Per Reel
						L	W	C			
PNF14-8LF-3K	16 – 14 AWG	Blue	0.03	0.162	#6	0.92	0.29	0.23	CD9-2A	CD-800-2	3000



### Locking Fork Terminals, Vinyl Insulated – Funnel Entry

#### Type PV-LFB

- Continuously molded design provides reliable, consistent performance through the applicator for a high quality termination every time
- Snap in place for secure connection
- Fork design provides for fast and easy installation, without the need to remove fastener
- Insulation support helps to prevent wire damage in bending applications
- UL Flammability UL 94V-0, maximum insulation temperature 221°F (105°C)
- UL and CSA rated to 600 V per UL 486A/B

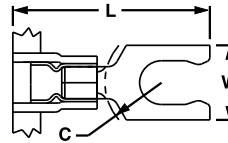

Part Number	Wire Range	Color Code	Stock Thickness In.	Max Ins. In.	Stud Size	Figure Dimensions In.			CA9 Series Crimp Die	CA-800/EZ Series Crimp Die	Pieces Per Reel
						L	W	C			
PV18-6LFB-3K	22 – 18 AWG	Red	0.03	0.150	#6	0.80	0.27	0.19	CD9-1A	CD-800-1	3000
PV18-8LFB-3K						0.87	0.29	0.23			
PV10-8LFB-2K	12 – 10 AWG	Yellow	0.04	0.225	#8	1.04	0.30	0.21	CD9-3B	CD-800-3	2000



### Female Disconnects, Nylon Fully Insulated – Funnel Entry

#### Type DNF-FIB

- Continuously molded design provides reliable, consistent performance through the applicator for a high quality termination every time
- Disconnect can be inserted and removed from the male tab without the use of tools for lower installed cost
- Fully insulated design provides protection from electrical shorts
- Disconnects available in common industry tab sizes
- Internal wire stop assures proper length of insertion into terminal barrel, providing a higher quality connection
- UL Flammability UL 94 HB, maximum insulation temperature 221°F (105°C)
- UL and CSA rated up to 600 V per UL 310

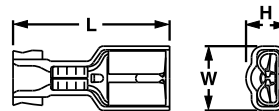

Part Number	Wire Range	Color Code	Max Ins. In.	Figure Dimensions In.			Tab Size		CA9 Series Crimp Die	CA-800/EZ Series Crimp Die	Pieces Per Reel
				L	W	H	In.	mm			
DNF18-111FIB-3K*	22 – 18 AWG	Red	0.120	0.71	0.19	0.15	0.110 x 0.020	2.8 x 0.5	CD9-7A	CD-800-7	3000
DNF18-188FIB-3K				0.78	0.29	0.16	0.187 x 0.020	4.8 x 0.5			
DNF18-206FIB-3K					0.84	0.31	0.22	0.187/0.205 x 0.020	4.8/5.2 x 0.5		
DNF18-250FIB-3K**				0.35		0.250 x 0.032		6.3 x 0.8			
DNF14-250FIB-3K	16 – 14 AWG	Blue	0.160	0.35	0.23	0.250 x 0.032	6.3 x 0.8	CD9-5A	CD-800-5	2000	
DNF10-250FIB-2K	12 – 10 AWG	Yellow	0.220	0.96				CD9-13B	CD-800-13		

\*UL/CSA standards do not exist for 0.110" x 0.010" receptacles

\*\*UL with 17 AWG wire





### Disco™ Female Disconnects, Nylon Fully Insulated – Expanded Wire Entry

#### Type DNF-FIBX

- Continuously molded design provides reliable, consistent performance through the applicator for a high quality termination every time
- Disconnect can be inserted and removed from the male tab without the use of tools for lower installed cost
- Expanded wire entry designed to accommodate wire with a larger insulation thickness
- Fully insulated design provides protection from electrical shorts
- Internal wire stop assures proper length of insertion into terminal barrel, providing a higher quality connection
- UL Flammability UL 94 HB, maximum insulation temperature 221°F (105°C)
- UL and CSA rated up to 600 V per UL 310

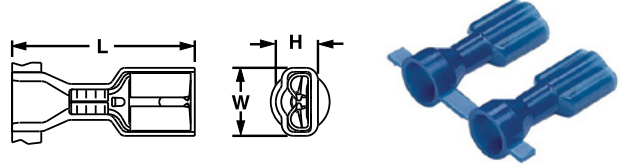

Part Number	Wire Range	Color Code	Max Ins. In.	Figure Dimensions In.			Tab Size		CA9 Series Crimp Die	CA-800/EZ Series Crimp Die	Pieces Per Reel
				L	W	H	In.	mm			
<a href="#">DNF18206FIBX-2K</a>	22 – 18 AWG	Red	0.210	0.87	0.31	0.22	0.187/0.205 x 0.020	4.8/5.2 x 0.5	CD9-6B	CD-800-6	2000
<a href="#">DNF18250FIBX-2K</a>				0.93	0.35		0.250 x 0.032	6.3 x 0.8			
<a href="#">DNF14250FIBX-2K</a>	16 – 14 AWG	Blue	0.240								



### Disco™ Female Disconnects, Nylon Fully Insulated – Right Angle

#### Type DNFR-FIB

- Continuously molded design provides reliable, consistent performance through the applicator for a high quality termination every time
- Right angle design for use in limited space applications
- Fully insulated design provides protection from electrical shorts
- Internal wire stop assures proper length of insertion into terminal barrel, providing a higher quality connection
- Disconnect can be inserted and removed from the male tab without the use of tools for lower installed cost
- UL Flammability UL 94 HB, maximum insulation temperature 221°F (105°C)
- UL and CSA rated up to 600 V per UL 310

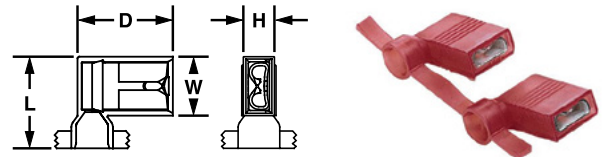

Part Number	Wire Range	Color Code	Max Ins. In.	Figure Dimensions In.				Tab Size		CA9 Series Crimp Die	CA-800/EZ Series Crimp Die	Pieces Per Reel
				L	W	H	D	In.	mm			
<a href="#">DNFR18205FIB-KD</a>	22 – 18 AWG	Red	0.178	0.57	0.37	0.21	0.60	0.187/0.205 x 0.032	4.8/5.2 x 0.8	CD9-9C	CD-800-9	1500
<a href="#">DNFR18206FIB-KD</a>								0.187/0.205 x 0.020	4.8/5.2 x 0.5			
<a href="#">DNFR18250FIB-KD</a>								0.250 x 0.032	6.3 x 0.8			
<a href="#">DNFR14250FIB-KD</a>	16 – 14 AWG	Blue										

- Product Showcase
- Abrasion Protection
- Cable Cleats
- Cable Ties
- Cable Tie Accessories
- Cable Tie Tools
- Identification Products
- Power Connectors
- Grounding Connectors
- Safety Solutions
- Stainless Steel Ties
- Terminals
- Wiring Duct
- Part Number Index



### Disco™ Female Disconnects, Vinyl Barrel Insulated – Funnel Entry

#### Type DV-B

- Continuously molded design provides reliable, consistent performance through the applicator for a high quality termination every time
- Disconnect can be inserted and removed from the male tab without the use of tools for lower installed cost
- Internal barrel serrations assure good wire contact and maximum tensile strength
- Internal wire stop assures proper length of insertion into terminal barrel, providing a higher quality connection
- UL Flammability UL 94V-0, maximum insulation temperature 221°F (105°C)
- UL and CSA rated up to 600 V per UL 310

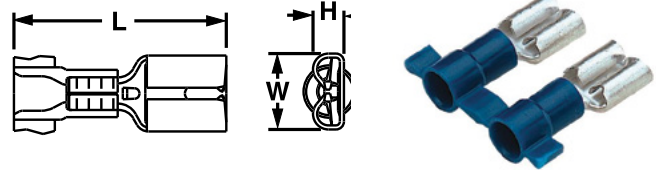

Part Number	Wire Range	Color Code	Max Ins. In.	Figure Dimensions In.			Tab Size		CA9 Series Crimp Die	CA-800/EZ Series Crimp Die	Pieces Per Reel
				L	W	H	In.	mm			
DV18-250B-3K	22 – 18 AWG	Red	0.150	0.83	0.29	0.12	0.250 x 0.032	6.3 x 0.8	CD9-1A	CD-800-1	3000
DV14-250B-3K	16 – 14 AWG	Blue	0.170						CD9-2A	CD-800-2	
DV10-250-2K*	12 – 10 AWG	Yellow	0.230	0.95				CD9-3B	CD-800-3	2000	

\*Not UL Listed or CSA Certified



### DiscoGrip™ Female Disconnects, Fully Insulated

#### Type DPF-FIB

- Continuously molded design provides reliable, consistent performance through the applicator for a high quality termination every time
- Disconnect can be inserted and removed from the male tab without the use of tools for lower installed cost
- Premium nylon insulation retains its shape when crimped and provides a tight grip around the wire insulation for maximum strain relief
- Fully insulated design provides protection from electrical shorts
- Internal wire stop assures proper length of insertion into terminal barrel, providing a higher quality connection
- Maximum insulation temperature 221°F (105°C)
- UL and CSA rated up to 600 V per UL 310

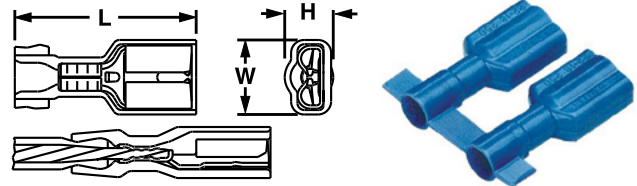

Part Number	Wire Range	Color Code	Max Ins. In.	Figure Dimensions In.			Tab Size		CA9 Series Crimp Die	CA-800/EZ Series Crimp Die	Pieces Per Reel
				L	W	H	In.	mm			
DPF14-250FIB-3K	16 – 14 AWG	Blue	0.160	0.84	0.35	0.22	0.250 x 0.032	6.3 x 0.8	CD9-11A	CD-800-11	3000



## Disco™ Male Disconnects, Nylon Fully Insulated – Funnel Entry

### Type DNF-FIM

- Continuously molded design provides reliable, consistent performance through the applicator for a high quality termination every time
- Male tab couples with (all 0.250 x 0.032) female disconnects
- Fully insulated design provides protection from electrical shorts
- Male tab can be inserted and removed from the female disconnect without the use of tools for lower installed cost
- UL Flammability UL 94 HB, maximum insulation temperature 221°F (105°C)
- UL and CSA rated up to 600 V per UL 310

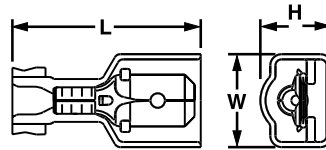

Part Number	Wire Range	Color Code	Max Ins. In.	Figure Dimensions In.			Tab Size		CA9 Series Crimp Die	CA-800/EZ Series Crimp Die	Pieces Per Reel
				L	W	P	In.	mm			
<b>Standard Housing</b>											
<a href="#">DNF18-250FIM-2K</a>	22 – 18 AWG	Red	0.133	0.90	0.42	0.30	0.250 x 0.032	6.3 x 0.8	<a href="#">CD9-4B</a>	<a href="#">CD-800-4</a>	2000
<a href="#">DNF14-250FIM-2K</a>	16 – 14 AWG	Blue	0.158						<a href="#">CD9-5B</a>	<a href="#">CD-800-5</a>	
<b>Oversized Housing</b>											
<a href="#">DNF18-250FIMB-K*</a>	22 – 18 AWG	Red	0.135	0.91	0.45	0.34	0.250 x 0.032	6.3 x 0.8	<a href="#">CD9-4B</a>	<a href="#">CD-800-4</a>	1000
<a href="#">DNF14-250FIMB-K*</a>	16 – 14 AWG	Blue	0.160		0.46				<a href="#">CD9-5B</a>	<a href="#">CD-800-5</a>	

\*To mate with other manufacturers' fully insulated 0.250 x 0.032 female receptacles



## Butt Splices Nylon Insulated

### Type BSN, BSP

- Continuously molded design provides reliable, consistent performance through the applicator for a high quality termination every time
- Designed to splice two solid or stranded wires together to repair or lengthen wires
- Butted configuration provides low profile for limited space applications
- Brazed seam protects terminal barrel from splitting during the crimp process
- Internal wire stop assures proper length of insertion into terminal barrel
- UL Flammability UL 94HB, maximum insulation temperature 221°F (105°C)
- UL and CSA rated up to 600 V per UL 486C

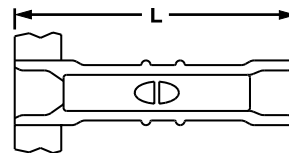

Part Number	Wire Range	Color Code	Max Ins. In.	Figure Dimensions In.	CA9 Series Crimp Die	CA-800/EZ Series Crimp Die	Pieces Per Reel
				L			
<a href="#">BSN18-3K</a>	22 – 16 AWG	Red	0.150	0.95	<a href="#">CD9-1A</a>	<a href="#">CD-800-1</a>	3000
<a href="#">BSN14-3K</a>	18 – 14 AWG	Blue	0.170		<a href="#">CD9-2A</a>	<a href="#">CD-800-2</a>	



### Insulated Ferrules on Reels – Single Wire and Mini Reels

#### Type FS

- Polypropylene insulation housing available in DIN standard colors in reels of 500 - 3000
- Designed specifically for use with Ferrule Applicator for high volume applications
- Continuously molded design provides consistent placement of ferrules in applicator to ensure fast, reliable terminations

- Available in #20 – 14 AWG featuring a seamless barrel design to contain loose wire strands for superior terminations

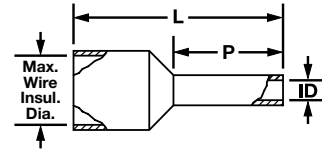

#### DIN End Sleeves

Part Number	Wire Size		Color	Max. Wire Ins. Dia.		Figure Dimensions						Wire Strip Length		CP-881 Inserts	Pieces per Reel
	AWG	mm <sup>2</sup>		In.	mm	L		P		ID		In.	mm		
<b>FSD77-8-3K2</b>	—	1	Red	0.11	2.8	0.57	14.5	0.31	8	0.06	1.5	13/32	10.0	Red	3000
<b>FSD78-8-2KD0</b>	16 AWG	1.5	Black	0.13	3.2					0.07	1.8			Black	2500

\*\*\*SCA-712022002 (CA10 applicator) and APM-MRSP1516JMD are no longer available. However, compatible dies are available. contact: tel:800-777-3300

#### Mini Reel

Part Number	Wire Size		Color	Max. Wire Ins. Dia.		Figure Dimensions						Wire Strip Length		CP-881 Inserts	Pieces per Reel
	AWG	mm <sup>2</sup>		In.	mm	L		P		ID		In.	mm		
<b>FSD77-8-K</b>	—	1	Red	0.11	2.8	0.57	14.5	0.31	8	0.06	1.5	13/32	10.0	Red	1000



**Like what you see and want more?**

Visit [www.panduit.com](http://www.panduit.com) for the full offering of Panduit products

# WIRING DUCT, SURFACE RACEWAY, AND WIRE BASKET

---

Panduct® Type F Narrow Slot Wiring Duct .....	184
Panduct® Type G Wide Slot Wiring Duct .....	185
Panduct® Flush Cover Type D Round Hole Wiring Duct .....	186
Panduct® Type FS Solid Wall Wiring Duct .....	186
Panduct® Type NE Halogen-Free Wiring Duct .....	187
Panduct® Type NNC Halogen-Free Metric Wiring Duct .....	187
Panduct® Type MC Metric Narrow Slot Wiring Duct .....	188
Panduct® Type H Hinged Cover Wide Slot Wiring Duct .....	188
Panduct® PanelMax™ DIN Rail Wiring Duct .....	189
Panduct® PanelMax™ Noise Shield .....	189
Panduct® PanelMax™ Shielding Wiring Duct .....	190
Panduct® PanelMax™ Corner Wiring Duct .....	191
Panduct® Type FL Flexible Wiring Duct .....	191
Panduct® Type G and H Wiring Duct Wire Retainers .....	191
Panduct® Divider Wall .....	192
Panduct® Installation Tools .....	192
Adhesive Tape Guide .....	192
Wire Basket Overhead Cable Routing System .....	193-199
Surface Raceway .....	200-214



### **Panduit® Type F Narrow Slot Wiring Duct**

- Narrow slot/finger design provides more slots to fit the spacing of high-density terminal blocks and other hardware
- Material: Lead-free PVC
- UL recognized continuous use temperature: 122°F (50°C)
- UL 94 flammability rating of V-0
- Conforms with NFPA 79-2015 section 13.3.1 requirement for flame retardant material
- Provided with mounting holes
- Base and cover length is 6 feet

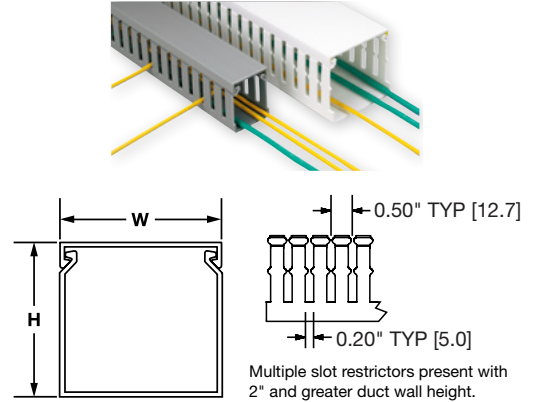
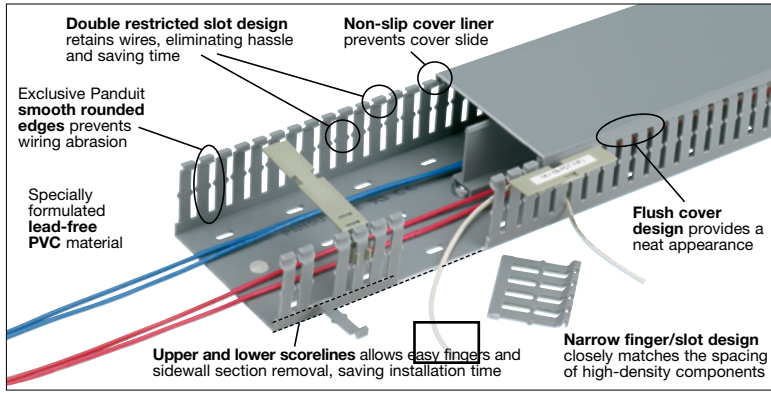

Part Number	Duct Size (W x H)*		Slot Width		Cover Part Number	Base Ctn. Qty.	Cover Ctn. Qty.
	In.	mm	In.	mm			
<b>F.75X1.5LG 6</b>	0.94 x 1.57	23.6 x 39.9	0.20	5.0	<b>C.75LG6</b>	120	120
<b>F1X1LG6</b>	1.25 x 1.13	32.0 x 28.7			<b>C1LG6</b>		
<b>F1X1.5LG6</b>	1.25 x 1.62	32.0 x 41.1			<b>C1LG6</b>		
<b>F1X2LG6</b>	1.25 x 2.12	32.0 x 53.8			<b>C1LG6</b>		
<b>BEST SELLER F1X3LG6</b>	1.25 x 3.13	32.0 x 79.4			<b>C1LG6</b>		
<b>F1X4LG6</b>	1.25 x 4.10	32.0 x 104.1			<b>C1LG6</b>		
<b>F1.5X1.5LG6</b>	1.75 x 1.62	44.5 x 41.1			<b>C1.5LG6</b>	60	
<b>F1.5X2LG6</b>	1.75 x 2.12	44.5 x 53.8			<b>C1.5LG6</b>		
<b>BEST SELLER F1.5X3LG6</b>	1.75 x 3.12	44.5 x 79.2			<b>C1.5LG6</b>	120	
<b>F1.5X4LG6</b>	1.75 x 4.10	44.5 x 104.1			<b>C1.5LG6</b>		
<b>F2X2LG6</b>	2.25 x 2.12	57.2 x 53.8			<b>C2LG6</b>	60	
<b>BEST SELLER F2X3LG6</b>	2.25 x 3.14	57.2 x 79.8			<b>C2LG6</b>		
<b>BEST SELLER F2X4LG6</b>	2.25 x 4.10	57.2 x 104.1			<b>C2LG6</b>	120	
<b>F2X5LG6</b>	2.25 x 5.10	57.2 x 129.5			<b>C2LG6</b>		
<b>F2.5X3LG6</b>	2.75 x 3.12	69.9 x 79.2			<b>C2.5LG6</b>	60	
<b>F3X2LG6</b>	3.25 x 2.12	82.6 x 53.8			<b>C3LG6</b>		
<b>F3X3LG6</b>	3.25 x 3.13	82.6 x 78.7			<b>C3LG6</b>	120	
<b>BEST SELLER F3X4LG6</b>	3.25 x 4.10	82.6 x 104.1			<b>C3LG6</b>		
<b>F3X5LG6</b>	3.25 x 5.10	82.6 x 129.5			<b>C3LG6</b>		
<b>F4X3LG6</b>	4.25 x 3.12	108.0 x 79.2			<b>C4LG6</b>		
<b>BEST SELLER F4X4LG6</b>	4.25 x 4.10	108.0 x 104.1	<b>C4LG6</b>				
<b>F4X5LG6</b>	4.25 x 5.10	108.0 x 129.5	<b>C4LG6</b>				
<b>BEST SELLER F6X4LG6</b>	6.25 x 4.15	158.8 x 105.4	<b>C6LG6</b>	60			

Part number shown for LG (Light Gray). For other sizes and color availability visit [www.panduit.com](http://www.panduit.com)  
 Base and cover sold separately  
 \*H\* dimension includes duct and cover

## UL® CE Panduct® Type G Wide Slot Wiring Duct

- Wide slot/finger design provides greater sidewall rigidity and can be used with a wide range of wire bundle sizes
- Material: Lead-free PVC
- UL recognized continuous use temperature: 122°F (50°C)
- UL 94 flammability rating of V-0
- Conforms with NFPA 79-20 5 section 13.3.1 requirement for flame retardant material
- Provided with mounting holes
- Base and cover length is 6 feet

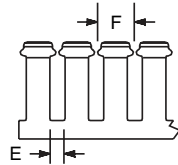

	E	F
For 0.5" duct height:	0.37" [9.4]	0.80" [20.3]
0.75" to 2" duct height:	0.31" [7.9]	0.80" [20.3]
3" to 4" duct height:	0.31" [7.9]	1.00" [25.4]
5" duct height:	0.38" [9.4]	1.33" [33.8]

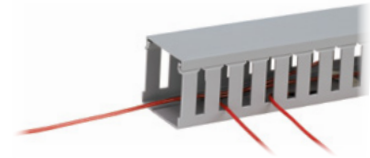

Base Part Number	Duct Size (W x H)*		Slot Width		Cover Part Number	Base Ctn. Qty.	Cover Ctn. Qty.				
	In.	mm	In.	mm							
G.5X2LG6	0.69 x 2.03	17.5 x 51.6	0.31	7.9	C.5LG6	120	120				
G.75X2LG6	0.94 x 2.03	23.6 x 51.7			C.75LG6						
G1X1LG6	1.25 x 1.12	32.0 x 28.4			C1LG6						
G1X1.5LG6	1.25 x 1.62	32.0 x 41.1			C1LG6						
G1X2LG6	1.25 x 2.12	32.0 x 53.8			C1LG6						
G1X3LG6	1.25 x 3.12	32.0 x 79.2			C1LG6						
G1X4LG6	1.25 x 4.10	32.0 x 104.1			C1LG6						
G1.5X1.5LG6	1.75 x 1.62	44.5 x 41.1			C1.5LG6						
G1.5X2LG6	1.75 x 2.12	44.5 x 53.8			C1.5LG6						
G1.5X3LG6	1.75 x 3.12	44.5 x 79.2			C1.5LG6						
G1.5X4LG6	1.74 x 4.10	44.5 x 104.1			C1.5LG6						
G2X1.5LG6	2.25 x 1.62	57.2 x 41.1			C2LG6						
G2X2LG6	2.25 x 2.12	57.2 x 53.8			C2LG6						
G2X3LG6	2.25 x 3.12	57.2 x 79.2			C2LG6						
G2X4LG6	2.25 x 4.10	57.2 x 104.1			C2LG6						
G2X5LG6	2.25 x 5.10	57.2 x 129.5			C2LG6						
G3X2LG6	3.25 x 2.12	82.6 x 53.8			0.31			7.9	C3LG6	120	60
G3X3LG6	3.25 x 3.12	82.6 x 79.2							C3LG6		
G3X4LG6	3.25 x 4.10	3.25 x 4.10	C3LG6								
G3X5LG6	3.25 x 5.10	82.6 x 129.5	0.38	9.7	C3LG6	60	120				
G4X3LG6	4.25 x 3.12	108.0 x 79.2	0.31	7.9	C4LG6						
G4X4LG6	4.25 x 4.10	108.0 x 104.1			C4LG6						
G4X5LG6	4.25 x 5.10	108.0 x 129.5	0.38	9.7	C4LG6						
G6X4LG6	6.23 x 4.15	158.8 x 105.4	0.31	7.9	C6LG6						

Part number shown for LG (Light Gray). For other sizes and color availability visit [www.panduit.com](http://www.panduit.com)

Base and cover sold separately

\*"H" dimension includes duct and cover



## Like what you see and want more?

Visit [www.panduit.com](http://www.panduit.com) for the full offering of Panduit products

### **Panduit® Flush Cover Type D Round Hole Wiring Duct**

- Round hole design has multiple rows of holes to retain and support wire at variable heights and positions
- Material: Lead-free PVC
- UL recognized continuous use temperature: 122°F (50°C)
- UL 94 flammability rating of V-0
- Conforms with NFPA 79-2015 section 13.3.1 requirement for flame retardant material
- Provided with mounting holes
- Base and cover length is 6 feet

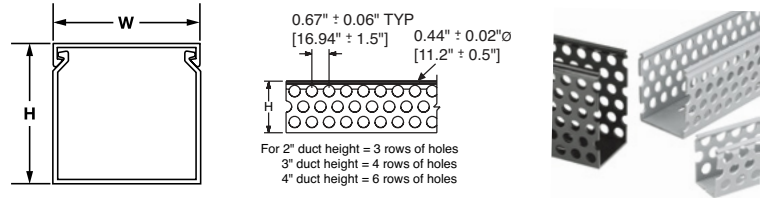

Base Part Number	Duct Size (W x H)*		Cover Part Number	Base Ctn. Qty.	Cover Ctn. Qty.
	In.	mm			
<b>D1.5X4LG6</b>	1.75 x 4.10	44.5 x 104.1	<b>C1.5LG6</b>	60	120
<b>D2X4LG6</b>	2.25 x 4.10	57.2 x 104.1	<b>C2LG6</b>		

Part number shown for LG (Light Gray). For other color availability visit [www.panduit.com](http://www.panduit.com)  
 Base and cover sold separately  
 \*"H" dimension includes duct and cover

### **Panduit® Type FS Solid Wall Wiring Duct**

- Solid wall design fully encloses cables providing maximum protection and aesthetics
- Material: Lead-free PVC
- UL recognized continuous use temperature: 122°F (50°C)
- UL 94 flammability rating of V-0
- Base and cover length is 6 feet
- Conforms with NFPA 79-2015 section 13.3.1 requirement for flame retardant material

Base Part Number	Duct Size (W x H)*		Cover Part Number	Base Ctn. Qty.	Cover Ctn. Qty.
	In.	mm			
<b>FS2X2LG6NM*</b>	2.25 x 2.14	57.2 x 54.4	<b>C2LG6</b>	120	120

\*Parts are available with mounting holes. To order with mounting holes, remove NM from part number  
 Part Number shown for LG (Light Gray). For other color availability visit [www.panduit.com](http://www.panduit.com)  
 Base and cover sold separately  
 \*"H" dimension includes duct and cover

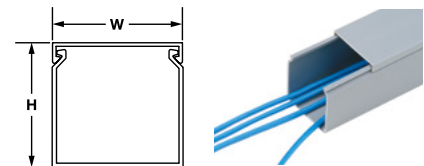

**Like what you see and want more?**

Visit [www.panduit.com](http://www.panduit.com) for the full offering of Panduit products

## Panduct® Type NE Halogen-Free Wiring Duct

- Material: Halogen-free polyphenylene oxide (PPO)
- UL recognized continuous use temperature: 203°F (95°C)
- UL 94 flammability rating of V-0
- Meets a Hazard Level Classification of HL1 per European Standard EN 45545-2 for R23 (exterior)
- Provided with mounting holes
- Base and cover length is 6 feet
- Conforms with NFPA 79-2015 section 13.3.1 requirement for flame retardant material

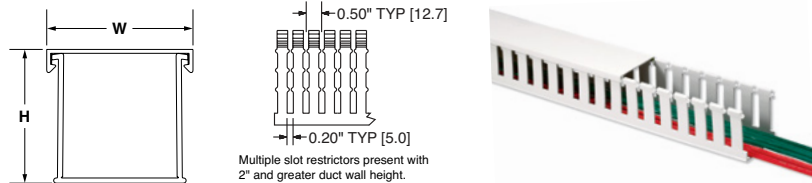

Base Part Number	Duct Size (W x H)*		Slot Width		Cover Part Number	Base Ctn. Qty.	Cover Ctn. Qty.		
	In.	mm	In.	mm					
NE1X1WH6*	1.14 x 1.06	29.0 x 26.9	0.31	7.9	NC1WH6	120	120		
NE1X2WH6	1.14 x 2.06	29.0 x 52.3			NC1WH6				
NE1X3WH6	1.14 x 3.06	29.0 x 77.7			NC1WH6				
NE1X4WH6	1.14 x 4.06	29.0 x 103.1			NC1WH6				
NE2X1WH6	2.14 x 1.08	54.4 x 27.4			NC2WH6	120			
NE2X2WH6*	2.14 x 2.08	54.4 x 52.8			NC2WH6				
NE2X3WH6	2.14 x 3.06	54.4 x 77.7			NC2WH6				
NE2X4WH6	2.14 x 4.06	54.4 x 103.1			NC2WH6				
NE3X4WH6	3.14 x 4.06	79.8 x 103.1			0.38	9.7		NC3WH6	60
NE3X5WH6	3.14 x 5.06	79.8 x 128.5						NC3WH6	
NE4X3WH6	4.14 x 3.06	105.2 x 77.7	NC4WH6						
NE4X4WH6*	4.14 x 4.06	105.2 x 103.1	0.31	7.9	NC4WH6				

Additional sizes available at [www.panduit.com](http://www.panduit.com)

\*Available in the solid NS duct without mounting holes

Available in WH (White) only

Do not allow cutting, tapping, or cleaning fluids that contain hydrocarbons to come in contact with type NE wiring duct as it will cause stress cracking

Base and cover sold separately

\*\*"H" dimension includes duct and cover

## Panduct® Type NNC Halogen-Free Metric Wiring Duct

- Material: Halogen-free polyphenylene oxide (PPO) material as verified with IEC 60754-2 test method (test on gases evolved during combustion of electric cables)
- UL recognized continuous use temperature: 203°F (95°C)
- UL 94 flammability rating of V-0
- Meets a Hazard Level Classification of HL1 per European Standard EN 45545-2 for R23 (exterior).
- Conforms with NFPA 79-2015 section 13.3.1 requirement for flame retardant material
- Provided with DIN 43 659 mounting holes
- Metric sizing and finger progression
- Duct and cover packaged together in two meter lengths

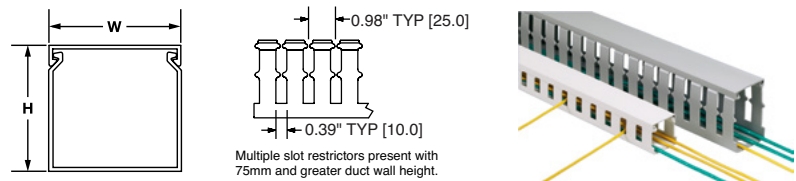

Base and Cover Part Number	Duct Size (W x H)*		Slot Width		Base and Cover Pkg. Qty. (m)
	In.	mm	In.	mm	
NNC50X75LG2	1.95 x 2.85	49.5 x 72.4	0.39	10.0	10
NNC75X75WH2	2.97 x 2.85	75.4 x 72.4			

More sizes available at [www.panduit.com](http://www.panduit.com)

Available in LG (Light Gray) and WH (White)

Do not allow cutting, tapping, or cleaning fluids that contain hydrocarbons to come in contact with type NNC wiring duct as it will cause stress cracking

\*\*"H" dimension includes duct and cover

### **UL** **CS** **CE** Panduct® Type MC Metric Narrow Slot Wiring Duct

- CE compliant and metric sizing for control panels intended for European applications
- Material: Lead-free PVC
- UL recognized continuous use temperature: 122°F (50°C)
- UL 94 flammability rating of V-0
- Conforms with NFPA 79-2015 section 13.3.1 requirement for flame retardant material
- Provided with DIN 43 659 mounting holes
- Duct and cover packaged together in 2m lengths

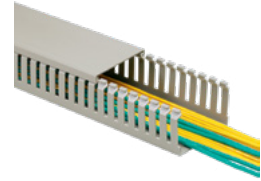
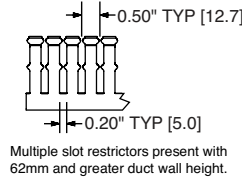
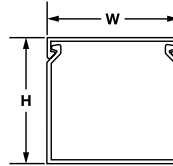

Base and Cover Part Number	Duct Size (W x H)*		Slot Width		Base and Cover Pkg. Qty. (m)
	In.	mm	In.	mm	
<b>MC50X75IG2</b>	1.95 x 2.85	49.5 x 72.4	0.20	5.0	10

More sizes available at [www.panduit.com](http://www.panduit.com)  
 Available in IG (International Gray) and WH (White) colors  
 Base and cover sold together  
 \*"H" dimension includes duct and cover

### **cUL** **us** **CS** **CE** Panduct® Type H Hinged Cover Wide Slot Wiring Duct

- Dual-sided hinged wiring duct cover snaps on to base, opens from either side and remains attached when opened. This provides faster access to wiring, prevents cover loss, reduces maintenance costs and promotes safety
- Excellent wire management for general purpose. The added stiffness also makes it suitable for indoor applications outside of the control panel
- Material: Lead-free PVC
- Rated for continuous use temperature: 122°F (50°C)
- UL 94 flammability rating of V-0
- Conforms with NFPA 79-2015 section 13.3.1 requirement for flame retardant material
- Provided with standard mounting holes
- Base and cover length is 6 feet

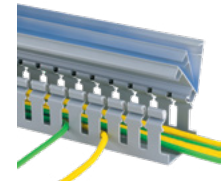
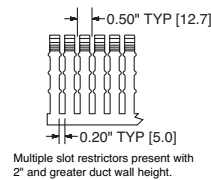
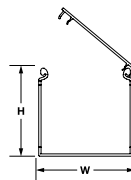

Base Part Number	Duct Size (W x H)*		Slot Width		Cover Part Number	Base Ctn. Qty.	Cover Ctn. Qty.
	In.	mm	In.	mm			
<b>H1.5X2LG6</b>	1.75 x 1.98	44.5 x 50.3	0.31	7.9	<b>HC1.5LG6</b>	120	120
<b>H2X4LG6</b>	2.17 x 4.10	55.1 x 104.1			<b>HC2LG6</b>	60	

Part Number shown for LG (Light Gray). For additional colors and sizes, as well as hinged solid wall and hinged narrow slot, visit [www.panduit.com](http://www.panduit.com)  
 Base and cover sold separately  
 \*"H" dimension includes duct and cover



## cULus® SP® CE Panduct® PanelMax™ DIN Rail Wiring Duct

- Space saving design positions DIN rail and components off the panel directly above an integrated wire management channel for up to a 30% smaller footprint for duct and components; increased design flexibility and component access for easier installation and maintenance
- DIN rail and DIN component compatible with standard 35mm or 15mm rails and many DIN rail mount components for design flexibility
- Integrated DIN rail fastening slot allows the DIN rail to mount directly to product with plastic thread cutting screws for up to 40% faster duct and rail installation and reduced labor costs
- Hinged cover remains attached during maintenance and upgrades preventing lost covers, ensuring panel integrity, safety and aesthetics; L-shaped cover acts as ledge to aid wire installation for ease of use
- Slotted platform (horizontal) manage the wire from channel mounted components, outer sidewall slots (vertical) manage wire from adjacent panel mounted components; unique finger and slot progression for optimal wire management and aesthetics
- Channel pass through slots allows wires to transition internally between channels to ease wire connections to either side of components mounted on the same rail minimizing wire length and reducing material cost
- Optional wire retainer accessory retains cabling with cover opened or removed easing wire installation and future wire additions

Part Number	Description	Std. Ctn. Qty.
DRD22LG6	2" height PanelMax™ DIN Rail Wiring Duct with dual wiring channels. 6.25" W x 2.12" H (158.7mm x 54.0mm). Base, covers and DIN rail fasteners included.	6 ft
DRD33LG6	3" height PanelMax™ DIN Rail Wiring Duct with dual wiring channels. 7.25" W x 3.14" H (184.1mm x 79.9mm). Base, covers and DIN rail fasteners included.	
DRD44LG6	4" height PanelMax™ DIN Rail Wiring Duct with dual wiring channels. 8.23" W x 4.12" H (209.0mm x 104.8mm). Base, covers and DIN rail fasteners included.	

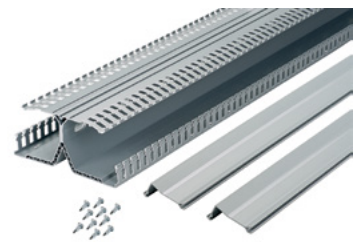

Product sold base and cover together in 6 ft. lengths. Replace LG with WH for white color  
Dimensions in parenthesis are metric

## Panduct® PanelMax™ Noise Shield

- Reduces EM1/RF1 noise between sensitive and noisy wiring for up to 20dB reduction in noise, or 90% NVR (equivalent to 6 inches of air spacing); innovative design installs easily within Panduit wiring duct or when mounted separately, delivering greater design flexibility to satisfy a wide range of applications
- Perforated and pre-scored sections speed installation by allowing sections of the shield to be snapped off at pre-scored locations to easily cut to length with minimal deburring required
- Vertical wall slots allow wires to cross the barrier at 90° when necessary, providing greater design flexibility
- Horizontal cable tie slots allow cable bundles to be held in place using cable ties so cabling is kept near barrier for greater reliability and optimal aesthetics
- Uncoated, corrosion resistant zinc plated steel surface contact area allows installation directly to metal sub panel. Included metal bonding clips enable mounting as a divider within Panduit wiring duct. Both options maintain continuity to ground
- Black powder coated vertical surface for smooth edges
- Meets UL 508/508A requirements as a barrier between conductors

Part Number	Description	Std. Pkg. Qty.
SD2EMI	EMI Noise Shield kit for 2" height Panduit Wiring Duct; (2) three foot sections, bonding clips, and anti-oxidizing paste	1
SD3EMI	EMI Noise Shield kit for 3" height Panduit Wiring Duct; (2) three foot sections, bonding clips, and anti-oxidizing paste.	
SD4EMI	EMI Noise Shield kit for 4" height Panduit Wiring Duct; (2) three foot sections, bonding clips, and anti-oxidizing paste	

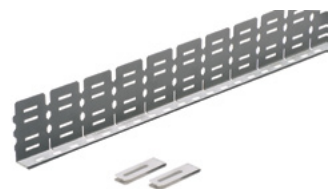

### Panduct® PanelMax™ Shielding Wiring Duct

- Durable and continuous metallic foil covers and shields outer duct surfaces providing EMI/RFI noise reduction between sensitive and noisy wiring for up to 20dB reduction in noise, or 90% NVR (equivalent to 6 inches of air spacing)
- Slotted sidewalls with horizontal bridge connectors provide wire management capability and noise reduction in the full height of the duct; slot size compatible with various wire types and sizes, including UTP Ethernet cabling
- High-quality Panduit PVC wiring duct base fully contains and protects wiring, easy to cut and install, and uses standard Panduit wiring duct covers
- Installs with standard fasteners including Panduit NR1 rivets

Part Number	Description	Std. Pkg. Qty.
G2X2LG6EMI	2" x 2" PanelMax™ Shielded Wiring Duct; 6-foot length. Foil metal finish includes anti-oxidizing paste. Cover sold separately.	12
G2X3LG6EMI	2" x 3" PanelMax™ Shielded Wiring Duct; 6-foot length. Foil metal finish includes anti-oxidizing paste. Cover sold separately.	
G2X4LG6EMI	2" x 4" PanelMax™ Shielded Wiring Duct; 6-foot length. Foil metal finish includes anti-oxidizing paste. Cover sold separately.	



**PanelMax Shielded Wiring Duct**

Use C2LG6 or C2WH6 cover with shielded wiring duct. Standard package quantity in feet. For tool information refer to [www.panduit.com/tools](http://www.panduit.com/tools)

### Performance Characteristics

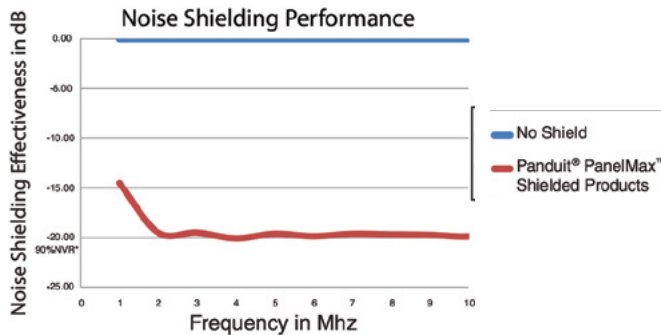

Relative noise reduction in decibels over frequency range of Panduit® PanelMax™ Shielded Wiring Duct and Noise Shield

PanelMax™ Shielded Wiring Duct and Noise Shield deliver approximately 20dB of noise reduction across common industrial noise frequencies at 30mm wire separation with an approximate 1-meter coupling length.

\*NVR (Noise Voltage Reduction percentage)



**Like what you see and want more?**

Visit [www.panduit.com](http://www.panduit.com) for the full offering of Panduit products

## Panduit® PanelMax™ Corner Wiring Duct

- Fits in the unused space in the vertical corner of enclosures, gaining sub-panel space or saving enclosure footprint area
- One-piece base requires less time to install than multi-piece solutions
- Optional quick mount clips engage anywhere along the product base further reducing assembly costs
- Panduit divider wall snaps directly to the integrated mounting feature in the channel to create two separate channels
- Improves aesthetics between back panel and side panel wiring connections

- Compatible with Panduit 2-inch, 3-inch, and 4-inch height wiring duct; all product sizes use standard 2-inch wiring duct cover
- Base and cover length is 6 feet
- Base and covers sold separately

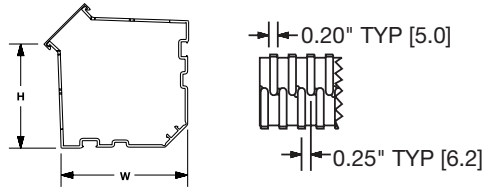

Base Part Number	Duct Size (W x H)*		Slot Width		Cover Part Number	Base Ctn. Qty.	Cover Ctn. Qty.
	In.	mm	In.	mm			
CWD3LG6	4.40 x 3.57	111.8 x 90.7	0.2	5.0	C2LG6	24	120
CWD4LG6	5.33 x 4.58	135.3 x 115.7			C2LG6		

## Panduit® Type FL Flexible Wiring Duct

- Material: Flexible Polypropylene
- UL Recognized continuous use temperature: 149°F (65°C)
- UL 94 flammability rating of V-2
- Factory applied adhesive tape provided for easy positioning\*\*
- Shelf Life: 5 yrs (adhesive tape)
- Flexible interlocking finger design eliminates need for covers
- Available -AV high bond adhesive variant provides durable, long lasting hold ideal for panel door and robotics applications

Part Number	Duct Size (W x H)*		Length		Std. Pkg. Qty.
	In.	mm	In.	mm	
FL12X12LG-AV	0.47 x 0.47	12 x 12	19.7	500	112
FL25X25LG-AV	0.98 x 0.98	25 x 25			70
FL50X50LG-AV	1.97 x 1.97	50 x 50			32

Additional sizes available at [www.panduit.com](http://www.panduit.com)  
 Available in LG (RAL 7040 Light Gray) color only. Unit of measure is pieces  
 \*\*"H" dimension includes duct and cover

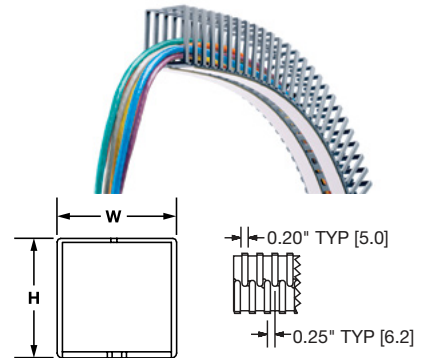

## Panduit® Type G and H Wiring Duct Wire Retainer

- Insert between fingers of type G and H to contain wiring when cover is removed
- Adjustable height
- Material: ABS



Part Number	For Nominal Duct Width In. (mm)	For Nominal Duct Height In. (mm)	Std. Pkg. Qty.	Std. Ctn. Qty.
WR2-C	2.00 (50.8)	2.00 – 4.00 (50.8 – 101.6)	100	1000

More sizes available at [www.panduit.com](http://www.panduit.com)

### Panduct® Divider Wall

- Wiring duct divider wall can be mounted inside any type of Panduit PVC wiring duct to create multiple channels
- Simply install the divider wall base when mounting the duct and snap the divider wall onto the mounting base
- All versions snap onto DB-C mounting base
- Divider wall heights 2 inches and greater have a scoreline feature allowing sections to be removed leaving a smooth edge
- Meets UL508/508A insulation material requirement for barrier between conductors
- Divider Wall material: Lead-free PVC, UL 94 flammability rating of V-0
- Mounting base material: Polycarbonate, UL 94 flammability rating of V-2

#### Panduct® Divider Wall Mounting Base

Part Number	Used with Anchors	Std. Pkg. Qty.	Std. Ctn. Qty.
DB-C	Panduit NR1 or #8, #10, M4 or M5 screw	100	1000



#### Panduct® Slotted Divider Wall

Part Number	For Nominal Duct Height		Length		Color	Std. Pkg. Qty.	Std. Ctn. Qty.
	In.	mm	Ft.	M			
SD2H6	2.00	50	6	—	Light Gray	6	120
SD3H6	3.00	75		—			
SD4H6	4.00	100		—			



Note: Must be used with mounting base, DB-C which is sold separately. Install mounting bases to the duct channel, locate within 2" of each divider wall end and at least every 12" along the length. Replace H with WH for White

### Panduct® Installation Tools

Easily cut Panduct® Products with the bench mount or hand-held duct cutting tool.



Part Number	Description	Std. Pkg. Qty.
DCT	Hand-held duct cutting tool	1
PBDCT*	Bench-mount duct cutting tool. Cuts slotted wiring ducts and wiring duct covers with up to 6" width and up to 5" height. Full 78.74" (2 meter) measuring scale. Includes safety guarding	
TNR	Hand-held nylon rivet installation tool	
NR1-M	Nylon rivet for use with TNR rivet tool	1000

\*Product comes in two separate boxes.

### Adhesive Tape Guide

Selection of wiring duct part numbers available with factory applied adhesive tape.

G Duct Light Gray	NE Duct White
G1X1LG6-A	—
G1X2LG6-A	—
G1X3LG6-A	—
—	NE2X2WH6-A
G2X3LG6-A	—



Additional G,F and NE adhesive sizes available on [www.panduit.com](http://www.panduit.com)

# Wire Basket Overhead Cable Tray Routing System

Maximize Space and Increase Network Performance in Industrial Automation Applications

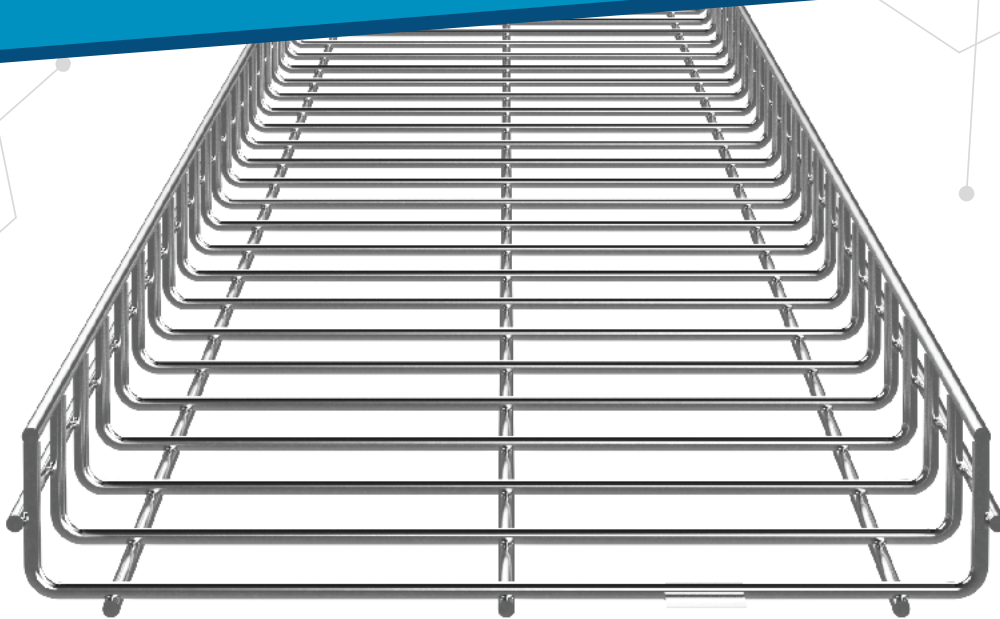

## Versatility

Can be used within industrial automation applications as well as data centers and connected buildings



## Adaptability

The wire basket's pathway sections are available in six standard widths and the basket's system includes multiple styles of mounting brackets to adapt to various support and building structures



## Designed Better

The pathway sections consist of a welded steel mesh that provides a higher strength-to-weight ratio and load-carrying capacity than the competition. The wire basket offers a safe working load that is 28 percent better than others on the market.

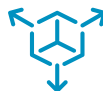

## Lighter and Larger

The basket is up to 20 percent lighter than other brands and has larger openings resulting in less cutting when completing applications such as sweeps by up to 50 percent\*



## Colorful Options

Available in three colors – black, white and electro zinc – to suit your data center needs



## Sustainability

Protection of the environment is critical; the wire basket is manufactured with a minimum 70 percent recycled steel.



## Splice It Up

Bolt-on, push-on, and expansion splices are used to join the sections of pathway together and create an electrically continuous connection



## Safety

Wire basket produces fewer sharp edges to better protect installers. With less weight, it is easier to install overhead. The basket is also UL Classified for suitability for use as Equipment Grounding Conductor\*\*

Like what you see and want more?

For more information about Wire Basket,  
[www.panduit.com/wire-basket](http://www.panduit.com/wire-basket)



\*Panduit engineering study

\*\*In accordance with Sections 392.6(A) and 392.(B) of the NFPA 70 National Electric Code with AMD 1-5 and NEMA VE1.



### Wire Basket Overhead Cable Tray Routing System

The Wire Basket Cable Tray Routing System is designed to route and manage copper data cables, fiber optic, or power cables within data centers, connected buildings, and industrial automation applications. Innovative features provide quick, safe, and easy assembly for reduced installation costs and faster deployment.

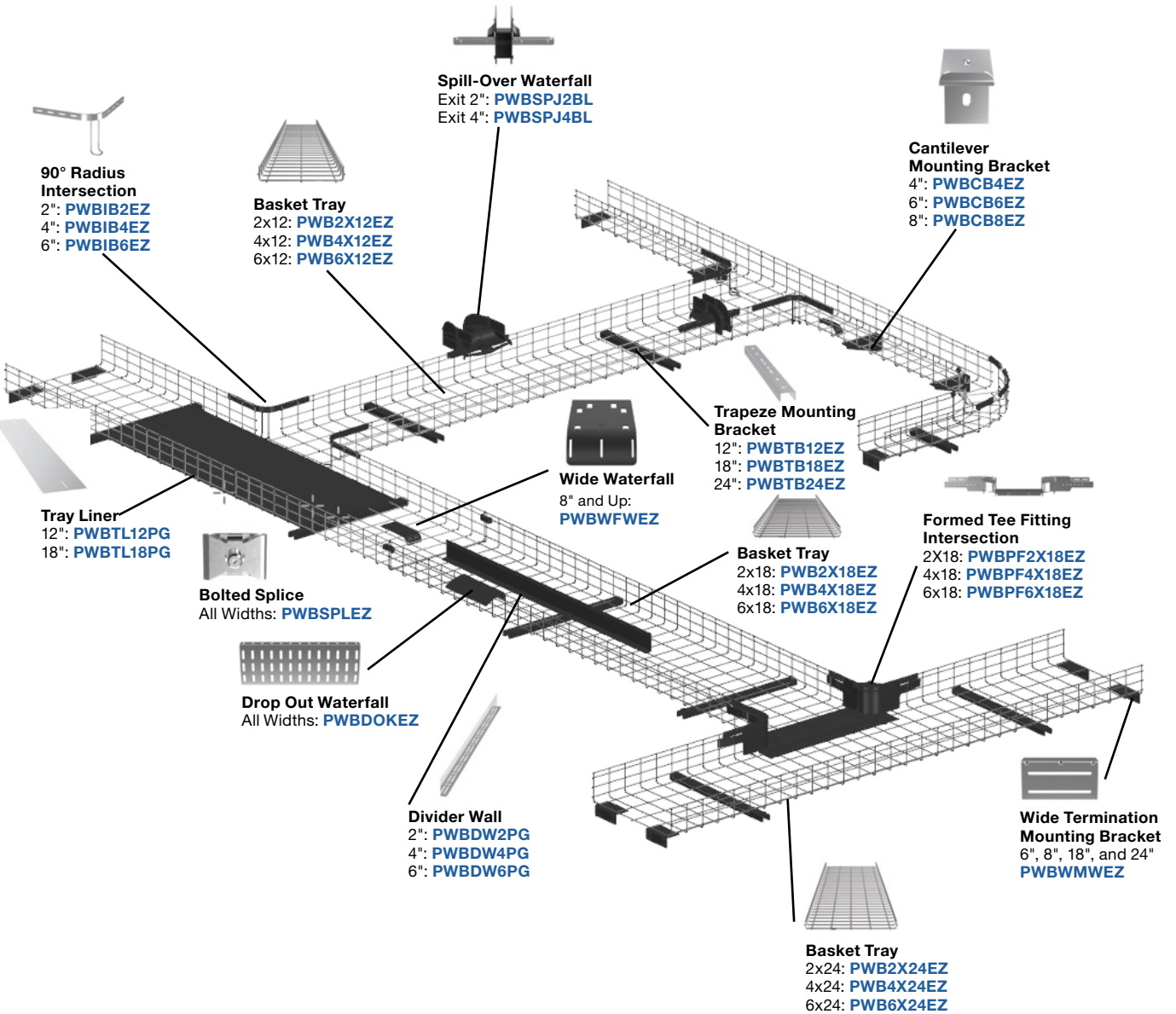

## Wire Basket Overhead Cable Tray Routing System

The Wire Basket Cable Tray Routing System is designed to support, route, and protect copper communication cables, fiber optic distribution cables, and power and control cables within data centers, commercial construction, and industrial infrastructure applications.

The system is composed of pathways, splices, mounting brackets, and accessories that can be configured to meet project requirements. Innovative features allow the system to be installed efficiently with less risk of installer injury or damage to the cabling infrastructure.

- Six pathway widths
- Three sidewall heights
- Three surface finish options: Electro Zinc (EZ), Black Powder Coat (BL), and White Powder Coat (WH).
- Flexible mounting options to meet project requirements and budgets
- Flexible cable exit options to protect and manage cable drops.

### Pathway Sections

Part Number	Height In. (mm)	Width In. (mm)	Length In. (mm)	Weight Lbs. (kg)
PWB2X4**	2.43 (61.6)	4.63 (117.7)	118.33 (3005.6)	14.0 (6.35)
PWB4X4**	4.43 (112.4)	4.63 (117.7)		10.0 (4.581)
PWB2X6**	6.43 (163.2)	6.63 (168.4)		10.8 (4.899)
PWB4X6**	4.43 (112.4)	6.63 (168.4)		14.5 (6.577)
PWB6X6**	6.43 (163.2)	6.63 (168.4)		18.5 (8.391)
PWB2X8**	2.43 (61.6)	8.63 (219.3)		11.5 (5.216)
PWB4X8**	4.43 (112.4)	8.63 (219.3)		15.2 (6.895)
PWB6X8**	6.43 (163.2)	8.63 (219.3)		19.2 (8.709)
PWB2X12**	2.43 (61.6)	12.63 (320.9)		14.1 (6.396)
PWB4X12**	4.43 (112.4)	12.63 (320.9)		17.9 (8.119)
PWB6X12**	6.43 (163.2)	12.63 (320.9)		21.8 (9.888)
PWB2X18**	2.43 (61.6)	18.63 (473.3)		17.3 (7.847)
PWB4X18**	4.43 (112.4)	18.63 (473.3)		21.2 (9.616)
PWB6X18**	6.43 (163.2)	18.63 (473.3)		25.0 (11.340)
PWB2X24**	2.43 (61.6)	24.63 (625.7)		20.6 (9.344)
PWB4X24**	4.43 (112.4)	24.63 (625.7)		24.5 (11.113)
PWB6X24**	6.43 (163.2)	24.63 (625.7)		28.2 (12.791)

NOTE: Replace \*\* With Color/Coating Option  
 BL = Black Powder Coated  
 WH = White Powder Coated  
 EZ = Electro Zinc  
 Ex: PWB2X4WH = 2" H x 4" W White Powder Coated Basket

### 3 Pathway Heights

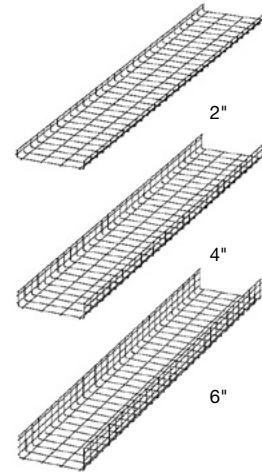

### 6 Pathway Widths

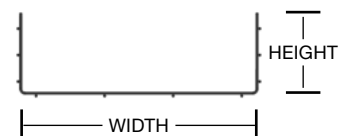
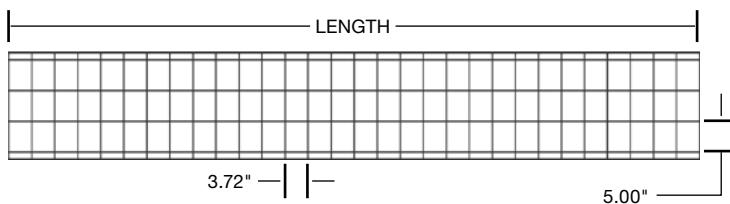
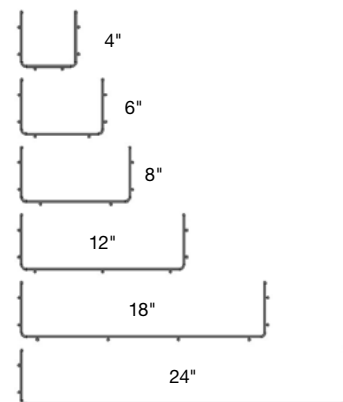

Wire Basket Hardware Kits are used to secure basket sections to flat mounting surfaces on support brackets, intersection bend fittings, and flat expansion bar accessories. Bolted splices are used for end-to-end pathway connections and to physically attach mating bottom surfaces at fabricated intersections.



**PWBHK\*\***  
Hardware Kit  
(Std. Pkg Qty = 50)



**PWBSPL\*\***  
Bolted Style Splice  
(Std. Pkg Qty = 50)

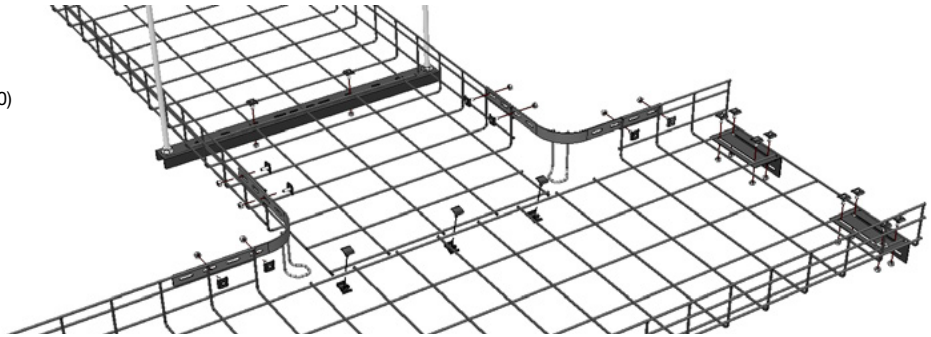

Wire Basket offers simplified splice options that meet the most demanding project requirements. Bolt-on splices firmly secure adjacent pathway sections and can form a UL Classified bond when installed as instructed. Innovative push-on splices offer faster installation without tools and flat expansion splice bars connect gaps between pathways and form in-line pathway width reductions.

Pathway Width In.	Splices Required
4	3
6	3
8	3
12	4
18	4
24	4

**PWBSPLBL and PWBSPLEZ:**

The Wire Basket Bolted Style Splice is available in black and electro zinc plated finish. This splice can be used to obtain a UL classified bond when properly applied over bare metal surfaces.

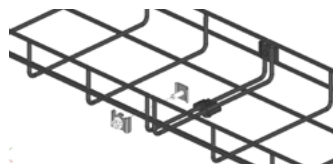

**PWBPSBL and PWBPSEZ:**

The push-on style splice quickly forms end-to-end connections without tools in applications that do not require the splice to form an electrical bond between pathway sections. It is available in black powder coat and electro zinc finishes.

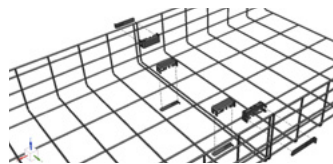

**PWBFESBL and PWBFSEZ:**

The Flat Expansion Splice Bar can be used to join two pathway sections together in applications where small gaps between horizontal pathways prevent the use of PWBSPL\*\* or PWBPS\*\* splice components.

The Flat Expansion Splice Bar can also be used to create field fabricated end-to-end width reductions between two pathway sections.

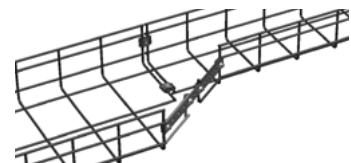
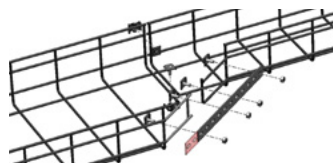
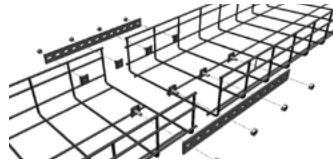

**NOTE:** Replace \*\* with BL for Black or EZ for Electro Zinc

Product Showcase

Abrasion Protection

Cable Cleats

Cable Ties

Cable Tie Accessories

Cable Tie Tools

Identification Products

Power Connectors

Grounding Connectors

Safety Solutions

Stainless Steel Ties

Terminals

Wiring Duct

Part Number Index

### Wire Basket Intersection Hardware

Right angle elbow and tee intersections use Radius Intersection 90 Brackets to secure pathway sections and protect cables transitioning around 90° intersections. Each Radius Intersection 90 Bracket includes two metal brackets to create two 90° intersections or one tee intersection. Wire Basket Hardware Kits are used to secure the Radius Intersection 90 Brackets to the adjoining pathway sections and Bolted Splices are used to secure the bottom surfaces together for enhanced strength and rigidity at intersections.

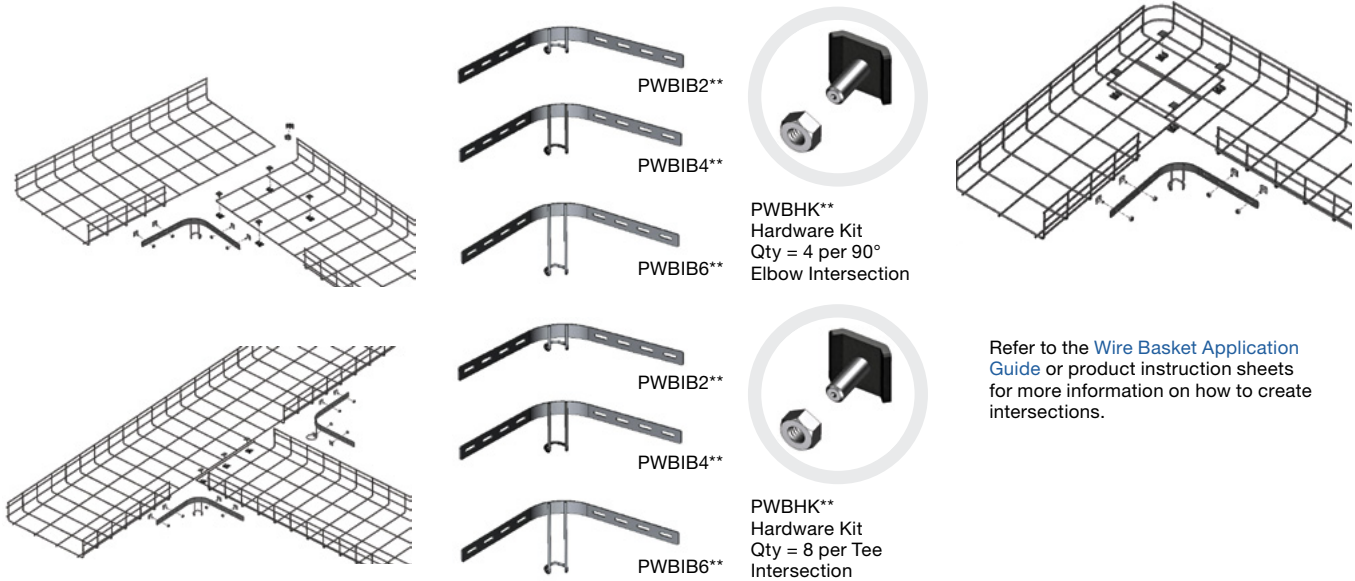

### Wire Basket Formed Tee Intersections

Wire Basket Formed Tees cover all cut pathways wires, maximize strength of the intersection, and provide smooth surfaces to protect cables routed through tee intersections.

Part Number	Description
PWBPF2X4**	Formed Tee Fitting 2"H x 4"W
PWBPF2X6**	Formed Tee Fitting 2"H x 6"W
PWBPF2X8**	Formed Tee Fitting 2"H x 8"W
PWBPF2X12**	Formed Tee Fitting 2"H x 12"W
PWBPF2X18**	Formed Tee Fitting 2"H x 18"W
PWBPF2X24**	Formed Tee Fitting 2"H x 24"W
PWBPF4X4**	Formed Tee Fitting 4"H x 4"W
PWBPF4X6**	Formed Tee Fitting 4"H x 6"W
PWBPF4X8**	Formed Tee Fitting 4"H x 8"W
PWBPF4X12**	Formed Tee Fitting 4"H x 12"W
PWBPF4X18**	Formed Tee Fitting 4"H x 18"W
PWBPF4X24**	Formed Tee Fitting 4"H x 24"W
PWBPF6X6**	Formed Tee Fitting 6"H x 6"W
PWBPF6X8**	Formed Tee Fitting 6"H x 8"W
PWBPF6X12**	Formed Tee Fitting 4"H x 12"W
PWBPF6X18**	Formed Tee Fitting 6"H x 18"W
PWBPF6X24**	Formed Tee Fitting 6"H x 24"W

**NOTE:** Replace \*\* with BL for Black, EZ for Electro Zinc, or WH for White

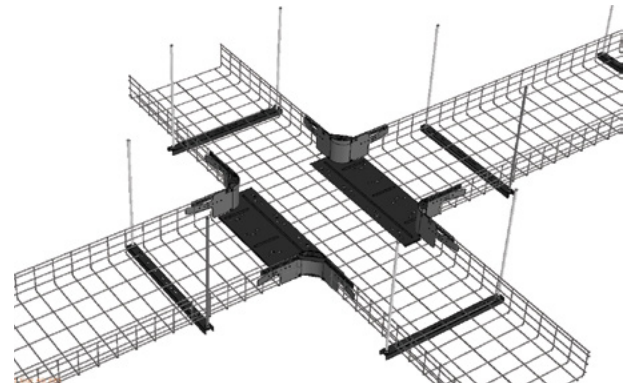
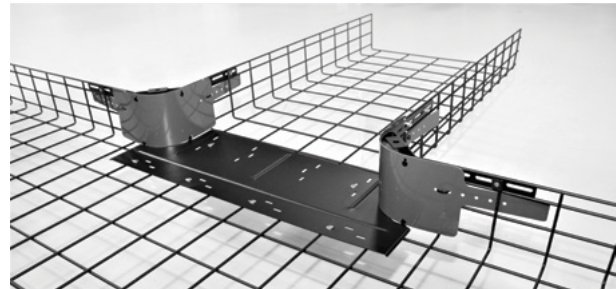

Product Showcase

Abrasion Protection

Cable Cleats

Cable Ties

Cable Tie Accessories

Cable Tie Tools

Identification Products

Power Connectors

Grounding Connectors

Safety Solutions

Stainless Steel Ties

Terminals

Wiring Duct

Part Number Index



### Wire Basket Mounting Brackets

Flexible mount bracket options allow the Wire Basket System to be installed in almost any configuration. Flat mounting surfaces simplify installation and allow pathway sections to safely slide over brackets as they are moved into position and baskets are secured to the brackets using two PWBHK\*\* Hardware Kit pieces per bracket.

#### Trapeze Brackets

Part Number	For Pathway Size	Threaded Rod Pitch In. (mm)	Length In. (mm)	Width In. (mm)	Height Thickness In. (mm)	PWBHKBL Hardware Pieces Required
-------------	------------------	-----------------------------	-----------------	----------------	---------------------------	----------------------------------

#### Existing Threaded Rod Brackets

PWBTB4BL	4" Wide Pathway	7.0 (177.8)	8.0 (216.0)	1.8 (45.7)	1.1 (27.9)	2
PWBTB6BL	6" Wide & Under	9.0 (228.6)	10.5 (266.0)			
PWBTB8BL	8" Wide & Under	11.0 (279.4)	12.5 (317.5)			
PWBTB12BL	12" Wide & Under	15.0 (481.0)	18.0 (457.0)			
PWBTB18BL	18" Wide & Under	21.0 (533.3)	22.5 (571.0)			
PWBTB24BL	24" Wide & Under	27.0 (685.8)	28.5 (725.0)			

#### Trapeze Hanger Brackets

Part Number	For Pathway Size	Threaded Rod Pitch In. (mm)	Length In. (mm)	Width In. (mm)	Height Thickness In. (mm)	Std. Pkg. Quantity
PWBTSBEZ	12" Wide & Under	N/A	N/A	N/A	N/A	50

#### Strut Mount Clips

PWBSCEZ	All	N/A	TBD By Contractor	1.625 (41) Wide Strut	Any Strut Height	50
---------	-----	-----	-------------------	-----------------------	------------------	----

#### Cantilever Brackets

Part Number	For Pathway Size	Length In. (mm)	Width In. (mm)	Height Thickness In. (mm)	PWBHKBL Hardware Pieces Required
PWBCB4BL	4" Wide Pathway	5.0 (128.0)	2.0 (50.0)	3.54 (90.0)	2
PWBCB6BL	6" Wide & Under	7.0 (178.0)		3.93 (100.0)	
PWBCB8BL	8" Wide & Under	8.7 (222.0)	1.6 (40.0)	3.57 (91.0)	
PWBCB12BL	12" Wide & Under	12.8 (326.0)		4.33 (110.0)	
PWBCB18BL	18" Wide & Under	18.7 (476.0)		5.51 (140.0)	
PWBCB24BL	24" Wide & Under	24.6 (626.0)		6.30 (160.0)	

#### Wall Mount Termination Brackets

PWBWMWBL	6", 8", 18" and 24"	6.2 (157.72)	2.12 (53.85)	3.12 (79.25)	4
PWBWMNBL	4" and 12"	4.7 (119.6)	2.12 (53.85)	3.12 (79.25)	2

Note: Replace BL with EZ for Electro Zinc or WH for White

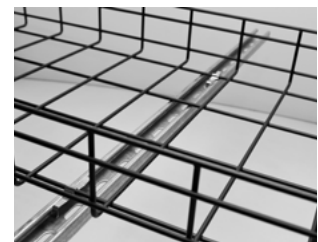

Product Showcase

Abrasion Protection

Cable Cleats

Cable Ties

Cable Tie Accessories

Cable Tie Tools

Identification Products

Power Connectors

Grounding Connectors

Safety Solutions

Stainless Steel Ties

Terminals

Wiring Duct

Part Number Index



### Wire Basket Waterfalls

Wire Basket spillouts are used to manage and protect cables routed between horizontally mounted baskets and vertical runs towards IT cabinets, racks, or equipment below. Flexible options allow spillouts to be sized appropriately to meet unique project requirements.

Bottom Waterfall Part Number	Description	Exit Width In. (mm)
<a href="#">PWBFWBL</a>	Wire Basket Wide Bottom Waterfall	3.54 (90)
<a href="#">PWBWFNBL</a>	Wire Basket Narrow Bottom Waterfall	1.61 (41)

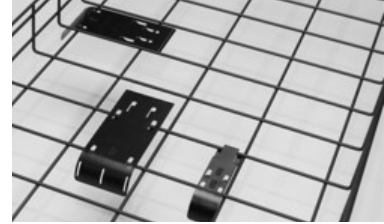

Drop Out Kit Part Number	Description	Exit Width In. (mm)
<a href="#">PWBOKBL</a>	Wire Basket 12" Drop Out Kit	12.5 (317.5)

Note: Replace BL with EZ for Electro Zinc or WH for White



Wire Basket Spillover Part Number	Description	Exit Width In. (mm)
<a href="#">PWBSPJ2BL</a>	Wire Basket Spillover Exit 2", Black	2.0 (50.8)
<a href="#">PWBSPJ4BL</a>	Wire Basket Spillover Exit 4", Black	4.0 (101.6)

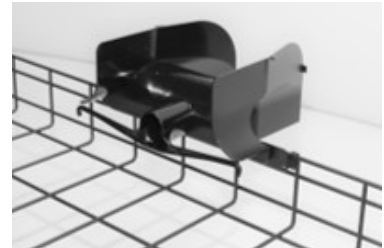

#### SPECIAL NOTE

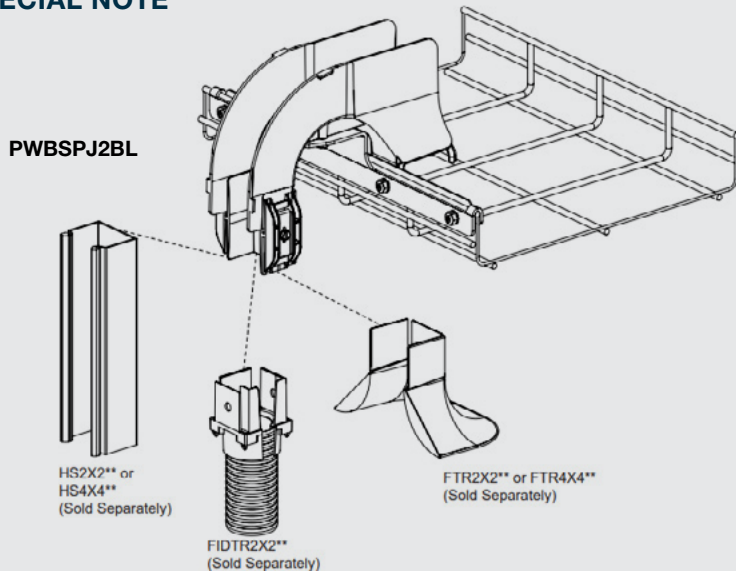

Optional accessories can be installed to the bottom back exit geometry of spillover fittings using FiberRunner FBC2X2LBL or FRBC4X4LBL barbed coupler fittings

Product Showcase

Abrasion Protection

Cable Cleats

Cable Ties

Cable Tie Accessories

Cable Tie Tools

Identification Products

Power Connectors

Grounding Connectors

Safety Solutions

Stainless Steel Ties

Terminals

Wiring Duct

Part Number Index

### Wire Basket Tray Liners and Divider Walls

Wire Basket Metal Tray Liners are available in six pathway widths and three surface finishes. Wire Basket Metal Divider Walls are available in three height options and can be installed anywhere across the width of Wire Basket pathway sections. Innovative mounting clips allow the Tray Liners and Divider Walls to pathway sections during the assembly process. Each Tray Liner and Divider Wall part number is sized to extend the full length of a 118.22 inches (3005.6 mm) Wire Basket.

Tray Liner Part Number	Description	Width In. (mm)
PWBTL4BL	Wire Basket Metal Tray Liner 4" W	3.33 (84.6)
PWBTL6BL	Wire Basket Metal Tray Liner 6" W	5.33 (135.4)
PWBTL8BL	Wire Basket Metal Tray Liner 8" W	7.33 (186.2)
PWBTL12BL	Wire Basket Metal Tray Liner 12" W	11.33 (287.8)
PWBTL18BL	Wire Basket Metal Tray Liner 18" W	17.33 (440.2)
PWBTL24BL	Wire Basket Metal Tray Liner 24" W	23.33 (592.6)



Divider Wall Part Number	Description	Height In. (mm)
PWBWDW2BL	Wire Basket Divider Wall 2" H	1.72 (43.7)
PWBWDW4BL	Wire Basket Divider Wall 4" H	3.72 (94.5)
PWBWDW6BL	Wire Basket Divider Wall 6" H	5.72 (145.31)



Note: Replace BL with EZ for Electro Zinc or WH for White



### Like what you see and want more?

For more Wire Basket Overhead Cable Tray Routing System options, visit [www.panduit.com/wire-basket](http://www.panduit.com/wire-basket)



- Product Showcase
- Abrasion Protection
- Cable Cleats
- Cable Ties
- Cable Tie Accessories
- Cable Tie Tools
- Identification Products
- Power Connectors
- Grounding Connectors
- Safety Solutions
- Stainless Steel Ties
- Terminals
- Wiring Duct
- Part Number Index

### Pan-Way® LD Surface Raceway System Roadmap

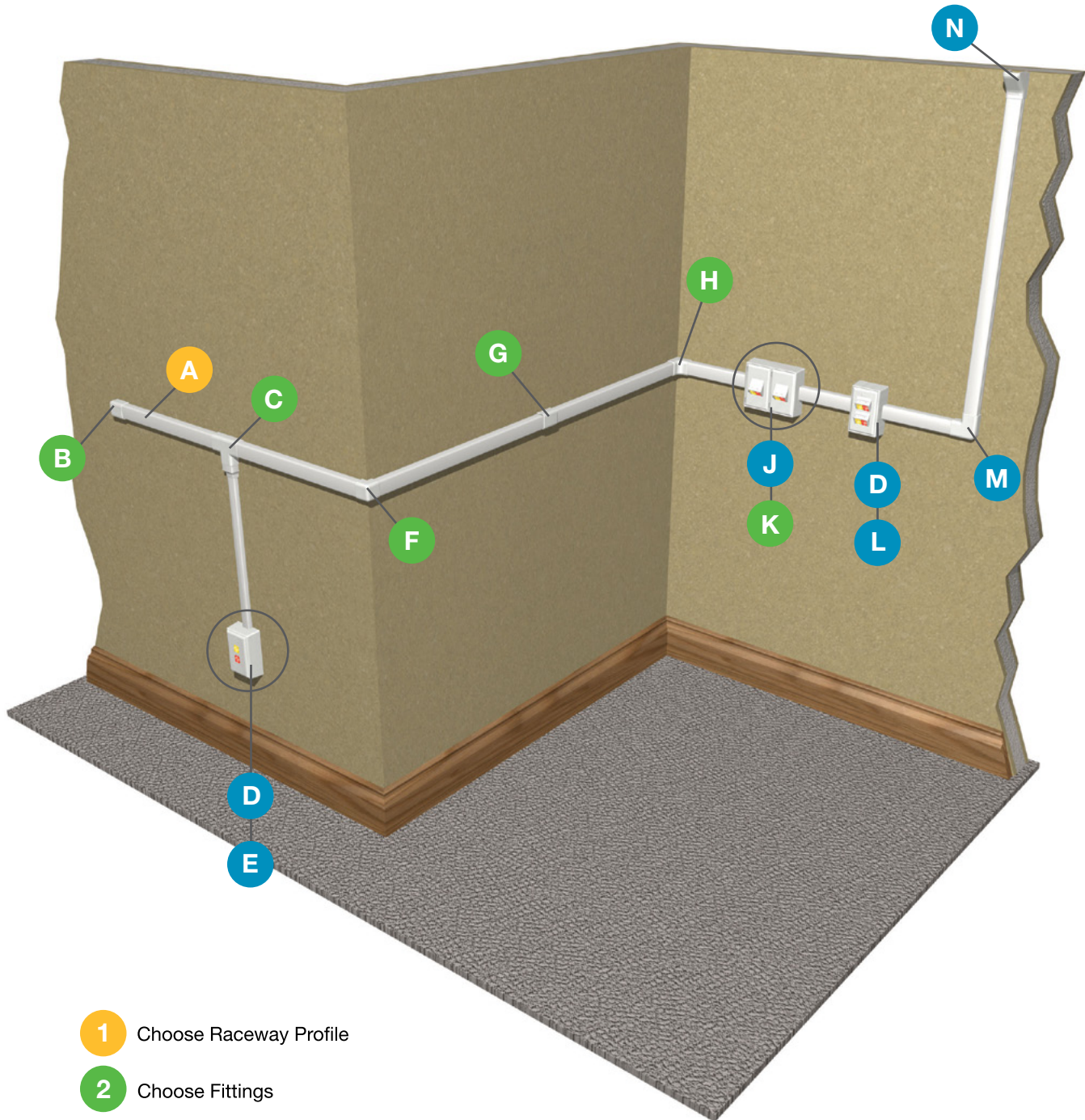
- One-piece, hinged design
- Single-channel

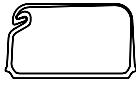
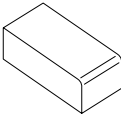
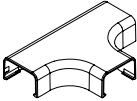
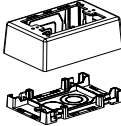

- 1 Choose Raceway Profile
- 2 Choose Fittings
- 3 Choose Accessories

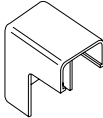
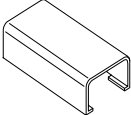
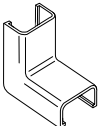
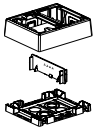
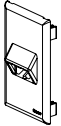
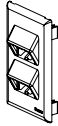
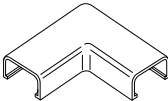
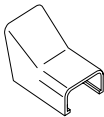
Product Showcase	<b>A</b>		LD10** – LD Profile Raceway Channel (see page 204)
Abrasion Protection	<b>B</b>		ECF10** – LD Profile End Cap Fitting (see page 204)
Cable Cleats	<b>C</b>		TFC10** – LD Profile Tee Fitting (see page 204)
Cable Ties	<b>D</b>		JBX3510** – Single Gang Two-Piece Snap-Together Box (see page 214)
Cable Tie Accessories	<b>E</b>		CPG** - Single Gang Rectangular Screw-On Faceplate (see page 214)
Cable Tie Tools	<b>F</b>		OCF10* – LD Profile Outside Corner Fitting (see page 204)
Identification Products	<b>G</b>		CF10** – LD Profile Coupler Fitting (see page 204)
Power Connectors	<b>H</b>		ICF10** – LD Profile Inside Corner Fitting (see page 204)
Grounding Connectors	<b>J</b>		JBP2FS** – Fast-Snap™ Double Gang Power Rated Surface Mount Outlet Box (see page 214)
Safety Solutions	<b>K</b>		T70FV2** – Snap-On Vertical Sloped Communication Faceplate (see page 214)
Stainless Steel Ties	<b>L</b>		T70FV4** – Snap-On Vertical Sloped Communication Faceplate (see page 214)
Terminals	<b>M</b>		RAF10** – LD Profile Right Angle Fitting M (see page 204)
Wiring Duct	<b>N</b>		DCF10** – LD Profile Drop Ceiling/Entrance End Fitting (see page 204)

## Pan-Way® LD Surface Raceway System Cable Fill Capacities

This information a guide to select the proper size raceway. The maximum amounts may vary according to the cable installation methods, straightness of cables, etc.



LD3	LD5	LD10
.21 in. <sup>2</sup>	.38 in. <sup>2</sup>	1.00 in. <sup>2</sup>

LDPH3	LDPH5	LDPH10
.17 in. <sup>2</sup>	.33 in. <sup>2</sup>	.89 in. <sup>2</sup>

Raceway Type and Configuration	Fill Area (in. <sup>2</sup> )	Electrical Cables			Data Grade Cables		Data Grade Cables		Audio/Video		Fiber Optic Cable	
		14 AWG	12 AWG	10 AWG	23 AWG/UTP		23 AWG/UTP CM		RG6		2 Strand	
		THHN/T90			Category 6 (4-pr.)		Category 6A		Dia. = 0.275		Dia. = 0.175	
		0.111	0.130	0.164	Dia. = 0.240		Dia. = 0.285		Dia. = 0.275		Dia. = 0.175	
		FILL			FILL		FILL		FILL		FILL	
		MAX	MAX	MAX	SPEC	MAX	SPEC	MAX	SPEC	MAX	SPEC	MAX
		(UL Temp Rise Test)			(40%)	(60%)	(40%)	(60%)	(40%)	(60%)	(40%)	(60%)
<b>LD3</b>	0.21				1	2	1	1	1	2	3	5
<b>LD5</b>	0.38	—	—	—	3	5	2	3	2	3	6	9
<b>LD10</b>	1.00				8	13	6	9	6	10	16	24
<b>LDPH3</b>	0.17	9	7	4	1	2	1	1	1	1	2	4
<b>LDPH5</b>	0.33	14	12	8	2	4	2	3	2	3	5	8
<b>LDPH10</b>	0.89	18	18	16	7	11	5	8	5	8	14	22

AWG dimensions represent typical outer cable Dia. in inches

For all cable options please see the Raceway cable fill calculator on [www.panduit.com/calculators](http://www.panduit.com/calculators)

SPEC = 40% cable fill – The recommended design in cable capacity, leaves room for future moves, adds, and changes

MAX for Data = 60% cable fill – The maximum cable quantity based on cable interweaving and packing factors

MAX for Power cable fill – The maximum of electrical cables based on UL temperature rise test



### Pan-Way® LD Surface Raceway System

- For routing data and low voltage cabling
- One-piece hinged design allows cables to be laid in
- Factory applied adhesive backing speeds installation
- FT4 rated
- Terminates using surface mount outlet box solutions or Mini-Com Surface Mount Boxes (see page 27)

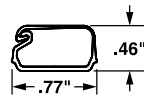

**LD3**  
Internal Area = .21 Sq. In.



**LD3**

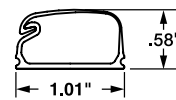

**LD5**  
Internal Area = .38 Sq. In.



**LD5**

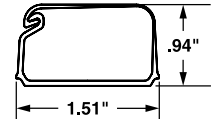

**LD10**  
Internal Area = 1.00 Sq. In.



**LD10**

#### LD Profile Raceway Channels

Part Number	Profile	Length Ft. (m)	Color**
<a href="#">LD3**6-A</a>	LD3	6.0 (152.4)	Electric Ivory (EI), Off White (IW), White (WH)
<a href="#">LD3**8-A</a>		8.0 (203.2)	
<a href="#">LD3**10-A</a>		10.0 (245.0)	
<a href="#">LD5**6-A</a>	LD5	6.0 (152.4)	
<a href="#">LD5**8-A</a>		8.0 (203.2)	
<a href="#">LD5**10-A</a>		10.0 (245.0)	
<a href="#">LD10**6-A</a>	LD10	6.0 (152.4)	
<a href="#">LD10**8-A</a>		8.0 (203.2)	
<a href="#">LD10**10-A</a>		10.0 (245.0)	

\*\*Insert colors White (WH), Off White (IW), or Electric Ivory (EI)

#### LD Profile Fittings

Part Number	Fitting Type	Color**
<a href="#">CF10** -X</a>	Coupler LD10	Electric Ivory (EI), Off White (IW), White (WH)
<a href="#">CF3** -E</a>	Coupler LD3/LD5	
<a href="#">CF5** -E</a>		
<a href="#">CF10** -E</a>		
<a href="#">ICFC3** -X</a>	Inside corner	
<a href="#">ICFC5** -X</a>		
<a href="#">ICFC10** -X</a>		
<a href="#">OCFC10** -X</a>	Outside Corner LD10	
<a href="#">OCFX3** -X</a>	Outside Corner LD3/LD5	
<a href="#">OCFX5** -X</a>		
<a href="#">OCFX10** -X</a>		
<a href="#">RAFC3** -X</a>	Right angle	
<a href="#">RAFC5** -X</a>		
<a href="#">RAFC10** -X</a>		
<a href="#">ECF10** -X</a>	End cap LD10	
<a href="#">ECF3** -E</a>	End cap LD3/LD5	
<a href="#">ECF5** -E</a>		
<a href="#">ECF10** -E</a>		
<a href="#">TFC3** -X</a>	Tee	
<a href="#">TFC5** -X</a>		
<a href="#">TFC10** -X</a>		
<a href="#">DCF3** -X</a>	Drop ceiling/entrance end	
<a href="#">DCF5** -X</a>		
<a href="#">DCF10** -X</a>		

\*\*Insert colors White (WH), Off White (IW), or Electric Ivory (EI)

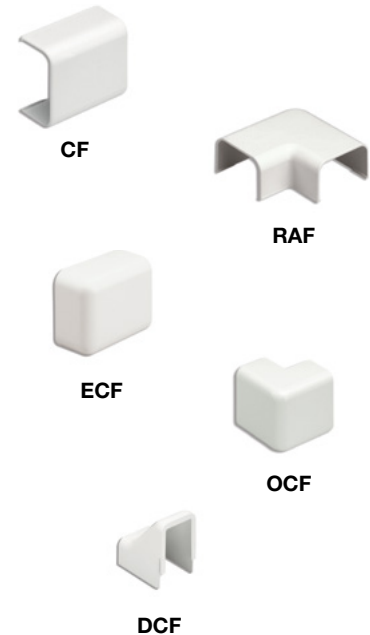

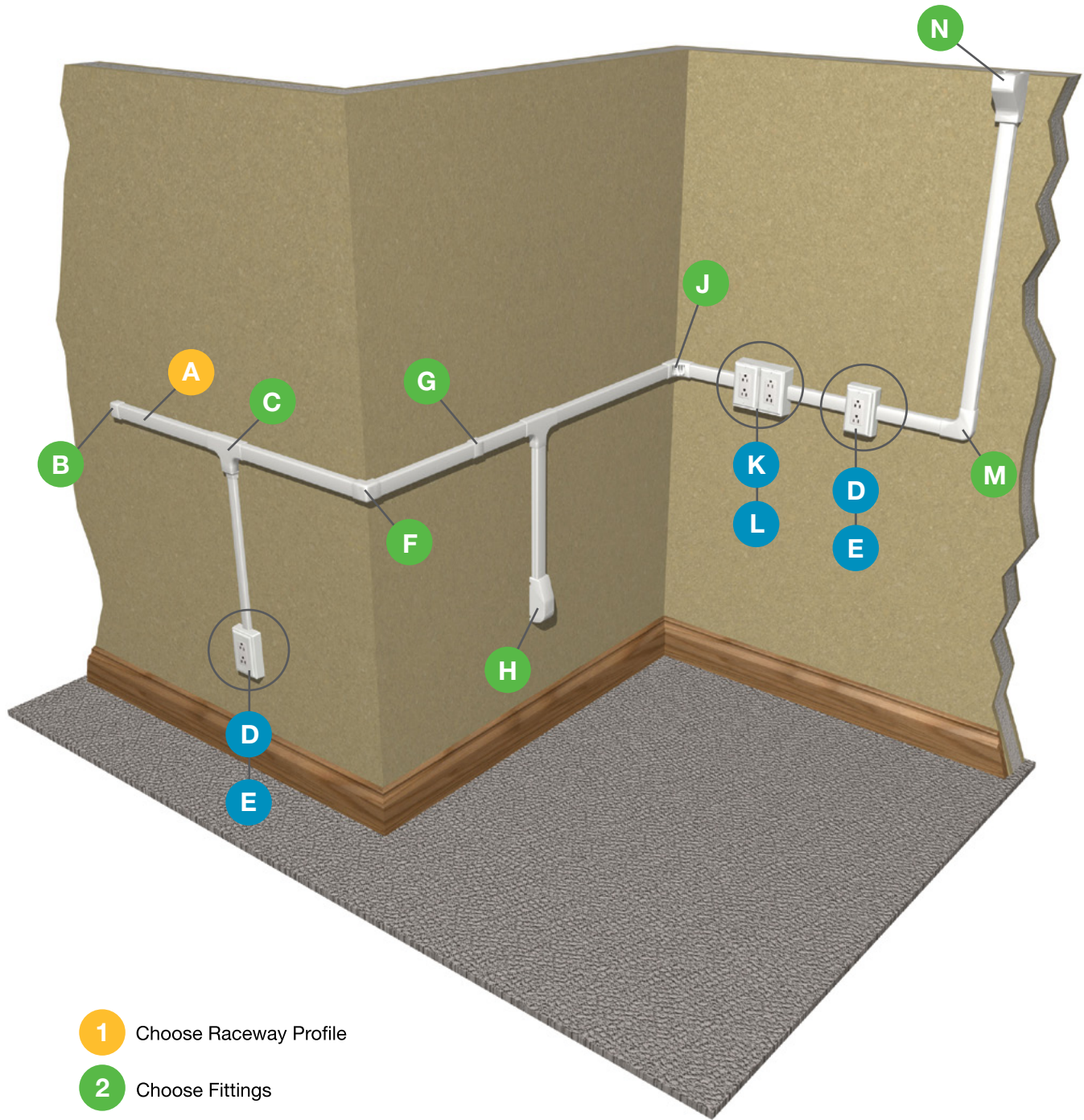

### Pan-Way® LDPH Surface Raceway System Roadmap

- Two-piece, hinged design
- Single-channel
- Power rated

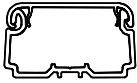
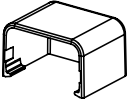
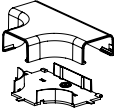
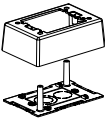

- 1** Choose Raceway Profile
- 2** Choose Fittings
- 3** Choose Accessories

Product Showcase
Abrasion Protection
Cable Cleats
Cable Ties
Cable Tie Accessories
Cable Tie Tools
Identification Products
Power Connectors
Grounding Connectors
Safety Solutions
Stainless Steel Ties
Terminals
<b>Wiring Duct</b>
Part Number Index

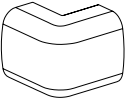
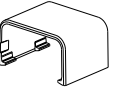
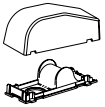
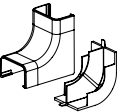
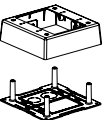
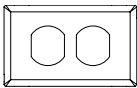
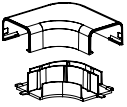
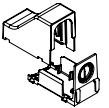
Product Showcase	<b>A</b>		<b>LDPH10**</b> – Raceway (see page 207)
Abrasion Protection	<b>B</b>		<b>ECFX10**</b> – Power Rated / 1" Bend Radius End Cap Fitting (see page 207)
Cable Cleats	<b>C</b>		<b>TFX10**</b> – Power Rated Tee Fitting (see page 207)
Cable Ties	<b>D</b>		<b>JBP1**</b> – Power Rated Single Gang Two-Piece Box (see page 214)
Cable Tie Accessories	<b>E</b>		<b>CPG**</b> – Single Gang Rectangular Screw-On Faceplate (see page 214)
Cable Tie Tools	<b>F</b>		<b>OCFX10**</b> – Power Rated Outside Corner Fitting (see page 207)
Identification Products	<b>G</b>		<b>CFX10**</b> – Power Rated / 1" Bend Radius Coupler Fitting (see page 207)
Power Connectors	<b>H</b>		<b>RAEFX10**</b> – Power Rated / 1" Bend Radius Right Angle Entrance End Fitting (see page 207)
Grounding Connectors	<b>J</b>		<b>ICFX10**</b> – Power Rated Inside Corner Fitting (see page 207)
Safety Solutions	<b>K</b>		<b>JBP2**</b> – Power Rated Double Gang Two-Piece Box (see page 214)
Stainless Steel Ties	<b>L</b>		<b>T70P**</b> – Double Gang Rectangular Screw-On Faceplates (see page 214)
Terminals	<b>M</b>		<b>RAFX10**</b> – Power Rated Right Angle Fitting (see page 207)
Wiring Duct	<b>N</b>		<b>DCEFX10**</b> – Power Rated / 1" Bend Radius Drop Ceiling Entrance End Fitting (see page 207) <i>Compatible with LDPH10 only*</i>

## cUL<sup>us</sup> Pan-Way® LDPH Surface Raceway System

- UL and CSA rated 600 V; meets UL 5A and CSA C22.2 No. 62.1-03 standards; FT4 rated
- Two-piece hinged design allows cables to be laid in
- Tamper resistant
- Factory applied adhesive backing speeds installation
- Terminates using surface mount outlet box solutions or Mini-Com Surface Mount Boxes

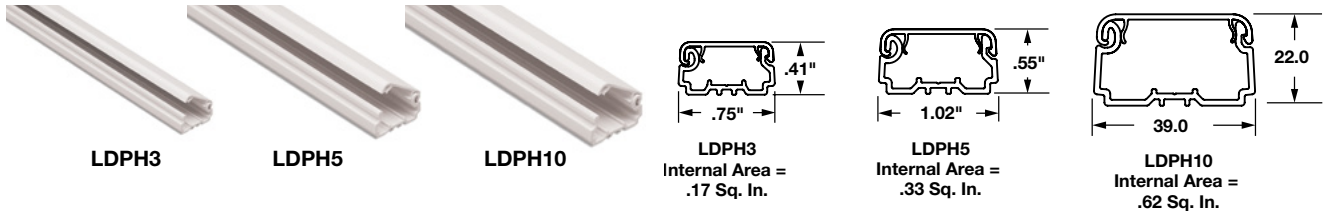

### LDPH Profile Channels

Part Number	Profile	Length Ft. (m)	Color**
LDPH3**6-A	LDPH3	6.0 (152.4)	Electric Ivory (EI), Off White (IW), White (WH)
LDPH3**8-A		8.0 (203.2)	
LDPH3**10-A		10.0 (245.0)	
LDPH5**6-A	LDPH5	6.0 (152.4)	
LDPH5**8-A		8.0 (203.2)	
LDPH5**10-A		10.0 (245.0)	
LDPH10**6-A	LDPH10	6.0 (152.4)	
LDPH10**8-A		8.0 (203.2)	
LDPH10**10-A		10.0 (245.0)	

\*\*Insert colors White (WH), Off White (IW), or Electric Ivory (EI)

### LD Profile Fittings

Part Number	Fitting Type	Colors**
OCFX <sup>^</sup> ** <sup>-</sup> X	Outside corner	Electric Ivory (EI), Off White (IW), White (WH)
ICFX <sup>^</sup> ** <sup>-</sup> X	Inside corner	
RAFX <sup>^</sup> ** <sup>-</sup> X	Right angle	
TFX <sup>^</sup> ** <sup>-</sup> X	Tee for LDPH3 and LDPH10	
ECFX <sup>^</sup> ** <sup>-</sup> X	End cap	
DCEFX <sup>**</sup> -X	LDPH10 Drop ceiling/entrance end	
RAEFX <sup>**</sup> -X	Right angle/entrance end	
CFX <sup>^</sup> ** <sup>-</sup> X	Coupler	

<sup>^</sup>Insert raceway size of 3', 5', or 10'

\*\*Insert colors White (WH), Off White (IW), or Electric Ivory (EI)







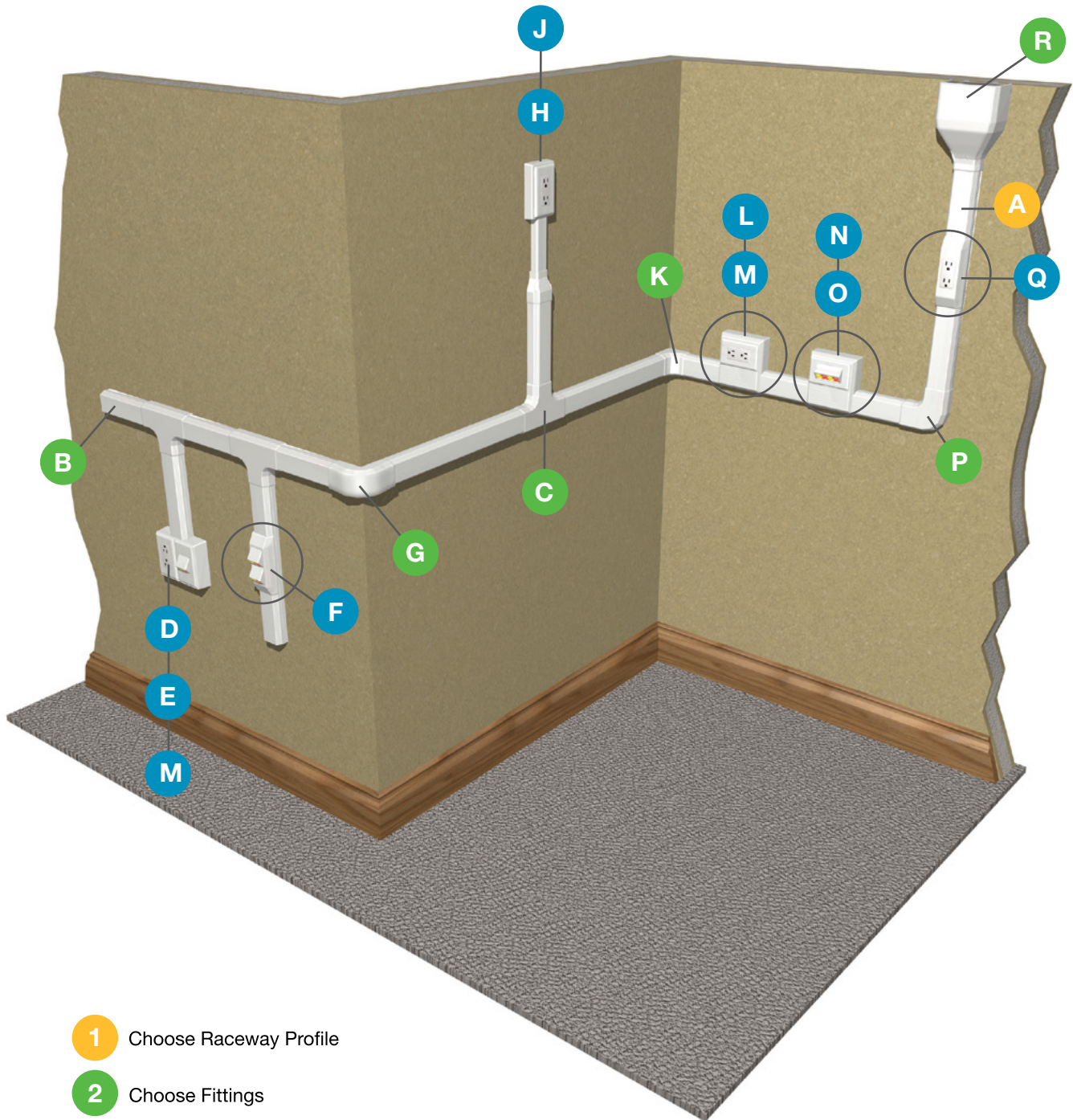

### Pan-Way® T-45 Surface Raceway System Roadmap

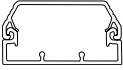

- Two-piece, hinged design
- Multi-channel (with divider wall)

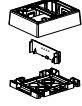
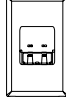
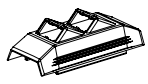

- 1 Choose Raceway Profile
- 2 Choose Fittings
- 3 Choose Accessories

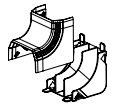
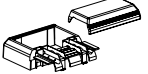
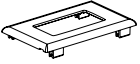
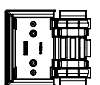
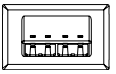
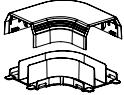

<b>A</b>		<b>T45B**</b> , <b>T45C**</b> – T-45 Raceway Base and Cover (see page 210)
<b>A</b>		<b>T45DW**</b> – T-45 Divider Wall (see page 210)
<b>B</b>		<b>T45EC**</b> – T-45 End Cap Fitting (see page 210)
<b>C</b>		<b>T45T**</b> – T-45 Tee Fitting (see page 210)
<b>D</b>		<b>JBP2FS**</b> – Fast-Snap™ Double Gang Power Rated Surface Mount Outlet Box (see page 214)
<b>E</b>		<b>T70FV2**</b> – Ultimate ID® Sloped Vertical Snap-On Faceplate (see page 214)
<b>F</b>		<b>T45HDB**</b> – T-45 Snap-On Hinged P Data Bracket (see page 210)
<b>G</b>		<b>T45OC**</b> – T-45 Outside Corner Fitting (see page 210)
<b>H</b>		<b>JBP1**</b> – Power Rated Single Gang R Two-Piece Box (see page 214)

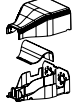
<b>J</b>		<b>CPG**</b> – Single Gang Rectangular Electrical / Communication Screw-On Faceplate (see page 214)
<b>K</b>		<b>T45IC**</b> – T-45 Inside Corner Fitting (see page 210)
<b>L</b>		<b>T45WC**</b> – T-45 Offset Box for Snap-On Faceplates (see page 214)
<b>M</b>		<b>T70PG**</b> – Single Gang Rectangular Electrical / Communication Snap-On Faceplate (see page 214)
<b>N</b>		<b>T45WC**</b> – T-45 Offset Box for Snap-On Faceplates (see page 214)
<b>O</b>		<b>T70FH4**</b> – Ultimate ID® Sloped Horizontal Snap-On Faceplate (see page 214)
<b>P</b>		<b>T45RA**</b> – T-45 Right Angle Fitting (see page 210)
<b>Q</b>		<b>T45HEGB**</b> – T-45 Electrical Bracket Q (see page 210)
<b>R</b>		<b>T45EE**</b> – T-45 Entrance End Fitting (see page 210)

- Product Showcase
- Abrasion Protection
- Cable Cleats
- Cable Ties
- Cable Tie Accessories
- Cable Tie Tools
- Identification Products
- Power Connectors
- Grounding Connectors
- Safety Solutions
- Stainless Steel Ties
- Terminals
- Wiring Duct
- Part Number Index



### Pan-Way® T-45 Surface Raceway System

- UL and CSA rated 600 V; meets UL 5A and CSA C22.2 No. 62.1-03 standards; FT4 rated
- Hinged cover allows easy access from either side
- Supplied with pre-punched mounting holes
- Tamper resistant
- Terminates using the T-45 hinged data or power brackets, offset box, or surface mount outlet box solutions

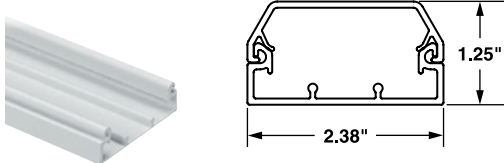

T45BIW10

T-45  
Internal Area = 2.12 Sq. In.

#### T-45 Profile Channels

Part Number	Profile	Length Ft. (m)	Color**
T45B**8	Base	8.0 (203.2)	Electric Ivory (EI), Off White (IW), White (WH)
T45B**10		10.0 (245.0)	
T45C**10	Cover	8.0 (203.2)	
T45CIW8			—
T45DW8	Divider Wall	10.0 (245.0)	—
T45DW10		—	—

\*\*Insert colors White (WH), Off White (IW), or Electric Ivory (EI)

#### T-45 Profile Fittings

Part Number	Profile	Color**
T45CC** -X	Cover coupler fitting	Electric Ivory (EI), Off White (IW), White (WH)
T45OC**	Outside corner fitting	
T45IC**	Inside corner fitting	
T45RA**	Right angle fitting	
T45EC**	End cap fitting	
T45EE**	Entrance end fitting	
T45T**	Tee fitting	

\*\*Insert colors White (WH), Off White (IW), or Electric Ivory (EI)

#### T-45 Accessories

Part Number	Profile	Color**
T45HDB**	Snap-On Hinged P Data Bracket	Electric Ivory (EI), Off White (IW), White (WH)
T45HEGB**	Electrical Bracket Q	

\*\*Insert colors White (WH), Off White (IW), or Electric Ivory (EI)

Product Showcase

Abrasion Protection

Cable Cleats

Cable Ties

Cable Tie Accessories

Cable Tie Tools

Identification Products

Power Connectors

Grounding Connectors

Safety Solutions

Stainless Steel Ties

Terminals

Wiring Duct

Part Number Index





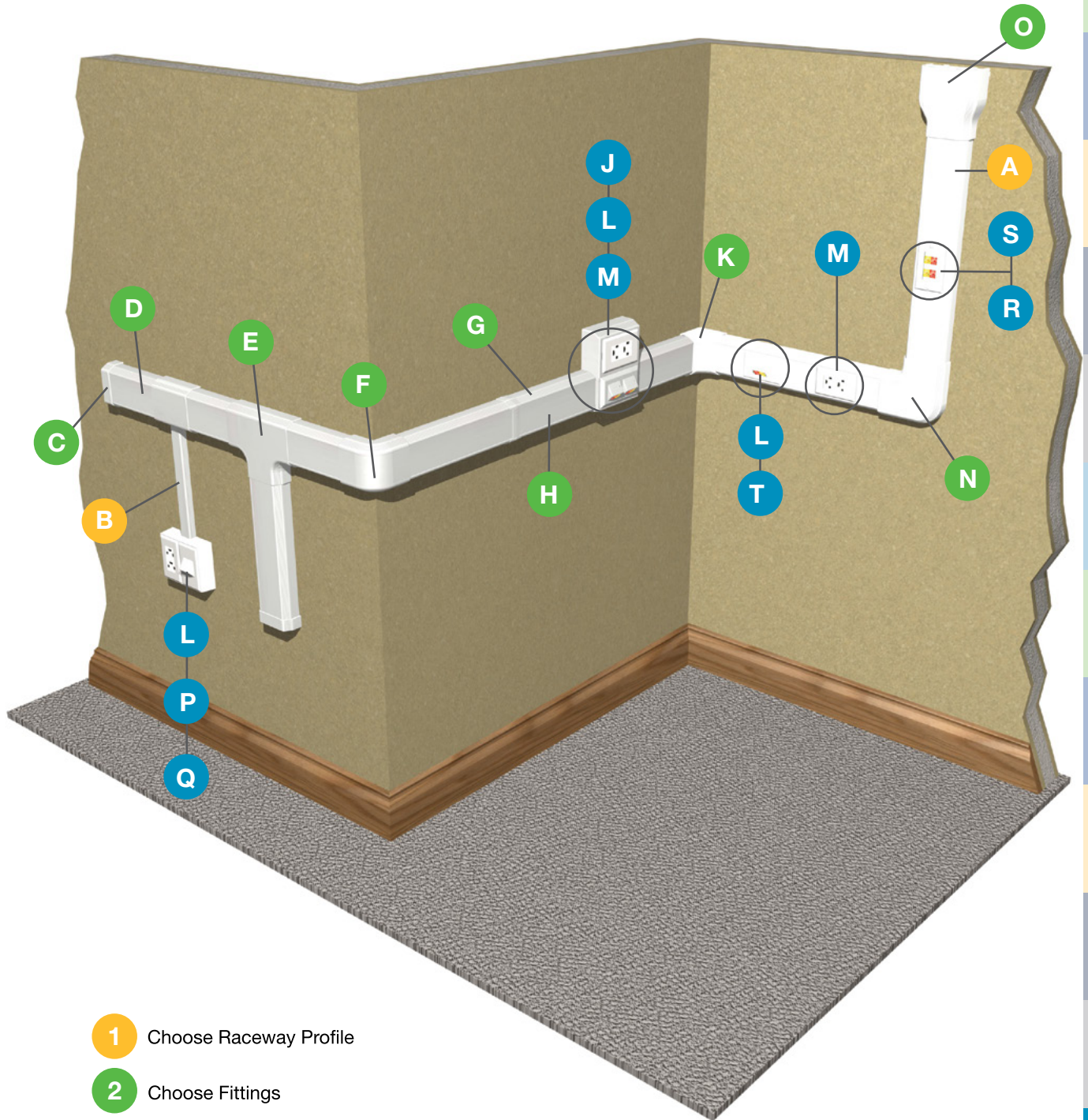





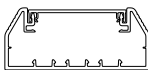
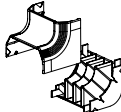

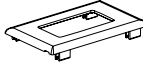
### Pan-Way® T-70 Surface Raceway System Roadmap

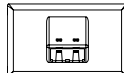
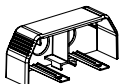
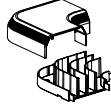
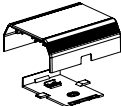
- Two-piece design
- Multi-channel (with divider wall)

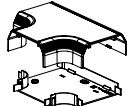
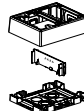
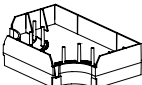

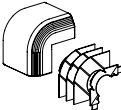
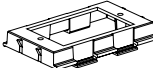
- 1 Choose Raceway Profile
- 2 Choose Fittings
- 3 Choose Accessories

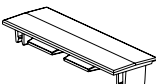
Product Showcase
Abrasion Protection
Cable Cleats
Cable Ties
Cable Tie Accessories
Cable Tie Tools
Identification Products
Power Connectors
Grounding Connectors
Safety Solutions
Stainless Steel Ties
Terminals
Wiring Duct
Part Number Index

Product Showcase	<b>A</b>		<b>T70B**</b> , <b>T70C**</b> – T-70 Base and Cover (see page 213)	<b>K</b>		<b>T70IC**</b> – T-70 Inside Corner Fitting (see page 213)
Abrasion Protection	<b>A</b>		<b>T70DW</b> – T-70 Divider Wall (see page 213)	<b>L</b>		<b>T70PG**</b> – Single Gang Rectangular Electrical / Communication Snap-On Faceplate (see page 214)
Cable Cleats	<b>B</b>		<b>LDPH10**</b> – LDPH Raceway (see page 207)	<b>M</b>		<b>T70FH2**</b> – Ultimate ID® Sloped Horizontal Snap-On Faceplate (see page 214)
Cable Ties	<b>C</b>		<b>T70EC**</b> – T-70 End Cap Fitting (see page 213)	<b>N</b>		<b>T70RA**</b> – T-70 Right Angle Fitting (see page 213)
Cable Tie Accessories	<b>D</b>		<b>T70TR**</b> – T-70 Transition Fitting (see page 212)	<b>O</b>		<b>T70EE**</b> – T-70 Entrance End Fitting (see page 213)
Cable Tie Tools	<b>E</b>		<b>T-70 Tee Fitting (T70T**)</b> <b>T70TD</b> – T-70 Tee Divider (see page 213)	<b>P</b>		<b>JBP2FS**</b> – Fast-Snap™ Double Gang Power Rated Surface Mount Outlet Box (see page 214)
Identification Products	<b>E</b>		<b>T70BC**</b> – T-70 Base Coupler Fitting (see page 213)	<b>Q</b>		<b>T70FV2**</b> – Vertical Sloped Communication Snap-On Faceplate (see page 214)
Power Connectors	<b>F</b>		<b>T70OC**</b> – T-70 Outside Corner Fitting (see page 213)	<b>R</b>		<b>T70DB-X</b> – T-70 Device Bracket (see page 212)
Grounding Connectors	<b>G</b>		<b>T70CC**</b> – T-70 Cover Coupler Fitting (see page 213)	<b>S</b>		<b>CPG**</b> – Single Gang Rectangular Screw-On Faceplate (see page 214)
Safety Solutions	<b>H</b>		<b>T70WC2**</b> – 70 Workstation Outlet Center™ Offset Box for Snap-On Faceplates (see page 214)	<b>T</b>		<b>T70HB3-X</b> – 3-Sided Hanging Box (see page 214)
Stainless Steel Ties	<b>J</b>					
Terminals						

## UL® SR® Pan-Way® T-70 Surface Raceway System

- UL and CSA rated 600 V; meets UL 5A and CSA C22.2 No. 62.1-03 standards; FT4 rated
- Large cable capacity with aesthetically pleasing design
- Tamper resistant
- Compatible with NEMA standard 70mm faceplates or Classic Series Snap-On Faceplates
- Transitions to T-45 and LD profile raceway
- Supplied with pre-punched mounting holes
- T-70 fittings are designed to maintain the TIA/EIA-568-B and 569-B required minimum bend radius for high performance copper and fiber optic cabling systems



T70B



T70C

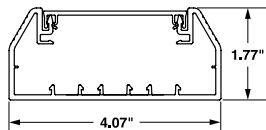

T-70  
Internal Area = 5.15 Sq. In.



T70RA



T70IC



T70T

### T-70 Profile Channels

Part Number	Profile	Length Ft. (m)	Color**
T70B**6	Base	6.0 (152.4)	Electric Ivory (EI), Off White (IW), White (WH)
T70B**8		8.0 (203.2)	
T70B**10		10.0 (245.0)	
T70C**6	Cover	6.0 (152.4)	
T70C**8		8.0 (203.2)	
T70C**10		10.0 (245.0)	
T70DW6	Divider Wall	6.0 (152.4)	—
T70DW8		8.0 (203.2)	
T70DW10		10.0 (245.0)	

\*\*Insert colors White (WH), Off White (IW), or Electric Ivory (EI)

### T-70 Profile Fittings

Part Number	Profile	Color**
T70BC**-X	Base coupling	Electric Ivory (EI), Off White (IW), White (WH)
T70CC**-X	Cover coupling	
T70OC**	Outside corner fitting	
T70IC**	Inside corner fitting	
T70RA**	Right angle fitting	
T70EC**	End cap fitting	
T70EE**	Entrance end fitting	
T70T**	Tee fitting	—
T70TD	Insert for tee fitting	
T70TR**	Transition Fitting	Electric Ivory (EI), Off White (IW), White (WH)

\*\*Insert colors White (WH), Off White (IW), or Electric Ivory (EI)

### T-70 Accessories

Part Number	Profile	Color
T70DB-X	Device Bracket	International Gray (IG)
T70HB3-X	3-Sided Hanging Box	



### UL LISTED SF SA LISTED Pan-Way® Junction Boxes

- Fast-snap boxes assemble without the use of screws and accept Snap-On Faceplates
- Fast-Snap boxes are supplied with adhesive backing to speed installation

Part Number	Description	Voltage Rating	Depth In. (mm)
<b>JBX3510**-A</b>	Single gang low voltage two-piece snap together outlet box with adhesive	Low Voltage	1.62 (41.15)
<b>JB1IW-A</b>	Single gang low voltage one-piece outlet box with adhesive		1.75 (44.45)
<b>JB1D**-A</b>	Single gang low voltage one-piece outlet box with adhesive, deep		2.75 (69.85)
<b>JBP1DIW</b>	Single gang two-piece screw together outlet box, deep	Power Rated	1.62 (41.15)
<b>JBP2IW</b>	Double gang two-piece screw together outlet box, standard		2.75 (69.85)
<b>JBP2SIW</b>	Double gang two-piece screw together outlet box, separated channel		
<b>JBP1D**</b>	Double gang two-piece screw together outlet box, deep		



**JB1D\*\*-A**



**JBP2D**

\*\*Insert colors White (WH), International White (IW), or Electric Ivory (EI)

### UL LISTED UL SA LISTED Above Floor Raceway

- ADA Compliant over floor raceway system
- Fast snap, tamper resistant base and cover
- Power rated 4 channel design

Part Number	Description	Length Ft. (m)	Color
<b>AFR4BCBL6</b>	Base and cover	6.0 (152.4)	Black
<b>AFR4JB2SBL</b>	Power rated two-piece snap together junction box	—	
<b>AFR4RABL</b>	Right angle fitting		
<b>AFR4CCBL</b>	Coupler fitting		
<b>AFR4ECBL</b>	End cap fitting		
<b>AFR4TBLGBL</b>	Table leg transition fitting		
<b>AFR4WTRBL</b>	Wall transition fitting		

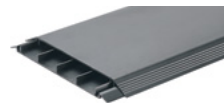

**AFR4BCBL6**



**AFR4CCBL**



**AFR4JB2SBL**

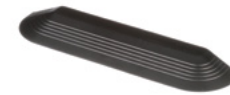

**AFR4ECBL**



**AFR4WTRBL**



**AFR4RABL**



**AFR4TBLGBL**

### Raceway Faceplates

Part Number	Description	Profile	Color**
<b>CPG**</b>	Single Gang Rectangular Screw-On	LD, LDPH, T-45, T-70	Electric Ivory (EI), Off White (IW), White (WH)
<b>T70FV2**</b>	Snap-On Vertical Sloped 2-Point Communication Faceplate	LD, T-45, T-70	
<b>T70FV4**</b>	Snap-On Vertical Sloped 4-Point Communication Faceplate	LD, T-70	
<b>T70P**</b>	Double Gang Rectangular Screw-On Faceplates	LDPH	
<b>T45WC**</b>	T-45 Offset Box for Snap-On Faceplates	T-45	
<b>T70PG**</b>	Single Gang Rectangular Electrical / Communication Snap-On Faceplate	T-45, T-70	
<b>T70FH4**</b>	Ultimate ID® Sloped Horizontal Snap-On Faceplate	T-45	
<b>T70WC2**</b>	T-70 Workstation Outlet Center Offset Box for Snap-On Faceplates	T-70	
<b>T70FH2**</b>	Ultimate ID® Sloped Horizontal Snap-On Faceplate	T-70	



**CPGIW**



**T70FV2IW**



**T70FV4IW**



**T70PIW**



**T45WCIW**



**T70PGIW**



**T70FH4IW**



**T70WC2IW**



**T70FH2IW**

\*\*Insert colors White (WH), Off White (IW), or Electric Ivory (EI)

## Index by Part Number

### A

ABM1M-AT-M0	77
ABM2S-A-C	77
ABM2S-A-D	77
ABM2S-AT-C0	77
ABM2S-AT-D0	77
ABM3H-A-L	77
ABM3H-AT-L0	77
ABM4H-A-L	77
ABM4H-AT-T0	77
ABM100-A-C	77
ABM100-AT-C0	77
ABM112-A-C	77
ABM112-AT-C0	77
ABMM-A-C	77
ABMM-A-D	77
ABMM-AT-C0	77
ABMM-AT-D0	77
ABMQS-A-C	66, 77
ACC19-A-C	79
ACC19-AT-M0	79
ACC38-A-C	79
ACC38-A-M	79
ACC38-AV-M300	79
ACC62-A-C	79
ACC62-A-D	79
ACC62-AV-D300	79
AFR4BCBL6	213
AFR4CCBL	213
AFR4ECBL	213
AFR4JB2SBL	213
AFR4RABL	213
AFR4TBLGBL	213
AFR4WTRBL	213
AJC25-A-C	79
ASMS-A-X	66
AST20-5-C100	76
AST25-5-C100	76

### B

BC2S-S10-C	58
BC4LH-S25-L0	58
BEC38-A-L	80
BEC62-A-T	80
BEC75-A-T	80
BSH10-E	172
BSH14-Q	172
BSH18-Q	172
BSN10-L	170
BSN14-3K	181
BSN14-C	170
BSN18-3K	181
BSN18-C	170
BSN22-C	170
BSV10X-Q	171
BSV14X-L	171
BSV18X-LY	171
BT1.5I-C	54
BT1.5I-C0	55
BT1.5I-M30	57
BT1.5M-C0	55
BT1.5M-XMR	90
BT1.5M-XMR30	90
BT1M-C	54
BT1M-C0	55
BT1M-XMR	90
BT1M-XMR0	90
BT1M-XMR30	90
BT2I-C	54
BT2I-C0	55
BT2LH-L0	56
BT2M-C0	55

BT2M-M30	57
BT2S-C	54
BT2S-C0	55
BT2S-M30	57
BT2S-M39	57
BT3I-C	54
BT3I-M30	57
BT3LH-L0	56
BT3S-C	54
BT3S-C0	55
BT3S-M0	55
BT4I-C0	55
BT4LH-L	54
BT4LH-TL0	56
BT4S-C	54
BT4S-C0	55
BT4S-M	54
BT4S-M0	55
BT4S-M30	57
BT5LH-C0	56
BT5LH-L	54
BT5LH-L0	56
BT7LH-L	54
BT7LH-L0	56
BT9LH-L	54
BT9LH-L0	56

### C

C1.5LG6	184-186
C1LG6	184-185
C2.5LG6	184
C2LG6	184-186, 191
C3LG6	184, 185
C4LG6	184, 185
C.5LG6	185
C6LG6	184-185
C.75LG6	184-185
C195X040Y1M	99
C261X035Y1M	99
CB70-14-CY	122
CBH15L50-V6	24
CBH20L50-V6	24
CBH25L50-V6	24
CBH30L50-V6	24
CBR1.5I-M0	61
CBR1.5M-M	60
CBR1M-M	60
CBR1M-M0	61
CBR2M-M	60
CBR2S-M0	61
CBR2S-M39	62
CBR3I-M	60
CBR3S-M	60
CBR3S-M0	61
CBR4S-M	60
CBR4S-M0	61
CCAL1H1013-X	25
CCAL1H1316-X	25
CCAL1H1619-X	25
CCAL1H1923-X	25
CCAL1H2327-X	25
CCAL1H2732-X	25
CCAL1H3238-X	25
CCAL1H3846-X	25
CCAL1H4651-X	25
CCAL1H5157-X	25
CCAL2H3846-X	25
CCAL2H4658-X	25
CCAL2H5870-X	25
CCAL2H7083-X	25
CCAL2H8397-X	25
CCAL2H97109-X	25
CCAL2H109120-X	25

CCALTR2326-X	24
CCALTR2528-X	24
CCALTR2730-X	24
CCALTR2932-X	24
CCALTR3135-X	24
CCALTR3438-X	24
CCALTR3741-X	24
CCALTR4044-X	24
CCALTR4347-X	24
CCALTR4651-X	24
CCALTR5056-X	24
CCALTR5561-X	24
CCALTR6067-X	24
CCALTR6675-X	24
CCPL1H1013-X	26
CCPL1H1316-X	26
CCPL1H1619-X	26
CCPL1H1923-X	26
CCPL1H2327-X	26
CCPL1H2732-X	26
CCPL1H3238-X	26
CCPL1H3846-X	26
CCPL1H4651-X	26
CCPL1H5157-X	26
CCPL2H3846-X	26
CCPL2H4658-X	26
CCPL2H5870-X	26
CCPL2H7083-X	26
CCPL2H8397-X	26
CCPL2H97109-X	26
CCPL2H109120-X	26
CCPL2H120135-X	26
CCPL2H135150-X	26
CCPL2H150165-X	26
CCPLTR2228-X	25
CCPLTR2633-X	25
CCPLTR3139-X	25
CCPLTR3745-X	25
CCPLTR4352-X	25
CCPLTR5060-X	25
CCSSQD2226-X	23
CCSSQD2529-X	23
CCSSQD2834-X	23
CCSSQD3339-X	23
CCSSQD3844-X	23
CCSSTR2025-X	23
CCSSTR2328-X	23
CCSSTR2632-X	23
CCSSTR3036-X	23
CCSSTR3440-X	23
CCSSTR3844-X	23
CCSSTR4248-X	23
CCSSTR4652-X	23
CCSSTR5057-X	23
CCSSTR5461-X	23
CCSSTR5865-X	23
CCSSTR6269-X	23
CEG-05X1	19
CEG-06X1	19
CEG-07X1	19
CEG-08X1	19
CEG-09X1	19
CEG-10X1	19
CEG-11X1	19
CEG-12X1	19
CEG-13X1	19
CEG-14X1	19
CEGBLS	19
CEST1-C6	18
CEST1-D7	18
CEST1-D8	18
CEST1-E8	18

CEST1-E12	18
CEST2-C6	18
CEST2-D7	18
CEST2-D8	18
CEST2-E8	18
CEST2-E12	18
CEST2-R504	19
CESU2-E12	20
CESU2-E13	20
CESU2-E14	20
CESU2-E17	20
CESU2-E17A	20
CESU2-E22	20
CESU2-E23	20
CESU2-E29	20
CESU2-RL508	20
CESU2-RL638	20
CESU2-RL6313	20
CESUM3-D12	20
CESUM3-E14	20
CESUM3-E23	20
CF3**E	203
CF5**E	203
CF10**E	203
CF10**X	203
CFX^**X	206
CLRCVR3-1	137
CLT25F-C20	11
CLT25N-C630	11
CLT38F-C20	11
CLT38N-C630	11
CLT50F-C3	11
CLT50F-C4	11
CLT50F-C20	11
CLT50N-4M630	11
CLT50N-C630	11
CLT62F-C20	11
CLT75F-2M20	11
CLT75F-C3	11
CLT75F-C4	11
CLT75F-C20	11
CLT75N-C630	11
CLT75PUV-0	11
CLT100F	11
CLT100F-C3	11
CLT100F-C20	11
CLT100N-125M630	11
CLT100N-C630	11
CLT100PUV-0	11
CLT125F-L20	11
CLT150F-D4F	11
CLT150F-T20	11
CLT150F-X4	11
CLT150F-X4F	11
CLT150F-X20	11
CLT150PUV-0	11
CLT188F-C20	11
CLT188PUV-0	11
CLTS25F-C	11
CLTS25N-C	11
CNBK	135
CPG	213
CR2-M	75
CR4H-M	75
CR4H-M0	75
CSB42-150-230-Q	22
CSB42-230-330-Q	22
CSB42-330-430-Q	22
CSCS-M	75
CSH-D0	75
CSH-D20	75

## Index by Part Number

Product Showcase

Abrasion Protection

Cable Cleats

Cable Ties

Cable Tie Accessories

Cable Tie Tools

Identification Products

Power Connectors

Grounding Connectors

Safety Solutions

Stainless Steel Ties

Terminals

Wiring Duct

Part Number Index

CT-810.....	125	DT4EH-L0.....	59	FSD78-12-D.....	173	GE255-L.....	10
CT-920.....	126	DT8EH-Q0.....	59	FSD80-8-D.....	173	GEE62F-A-C.....	10
CT-980.....	126	DT14EH-L0.....	59	FSD80-12-D.....	173	GEE62F-A-C0.....	10
CT-1250.....	125	DT28EH-C0.....	59	FSD81-10-D.....	173	GEE99F-A-C.....	10
CT-1700.....	125	DT44EH-C0.....	59	FSD81-12-C.....	173	GEE99F-A-C0.....	10
CT-1701.....	125	DTHEH-Q0.....	59	FSD82-12-C.....	173	GEE99F-C.....	10
CT-2600/LBT.....	127	DTHH-Q0.....	59	FSD83-12-C.....	174	GEE144F-A-C.....	10
CT-2920/CCPBT.....	128	DTKEH-0.....	59	FT38-C.....	14	GEE144F-A-C0.....	10
CT-2931/STBT.....	128	DTREH-LR0.....	59	FT50-C.....	14	GEE144F-C.....	10
CT-2940/STBT.....	128	DTRH-LR0.....	59	FT62-C.....	14	GEE189F-A-C.....	10
CT-2980/STBT.....	128	DV10-250-2K.....	180	FT75-C.....	14	GEE189F-A-C0.....	10
CT-3001/CCPBT.....	127	DV10-250-L.....	169	FT125-C.....	14	GEE189F-C.....	10
CT-3001/STBT.....	127	DV14-250B-3K.....	180	FT150-C.....	14	GEE189F-C0.....	10
CT-3980/BT.....	127	DV14-250B-C.....	169	FT200-L.....	14	GES62F-A-C.....	10
CTAP2/0-2-X.....	141	DV18-250B-3K.....	180	FT300-L.....	14	GES62F-A-C0.....	10
CTAP2-2-X.....	141	<b>E</b>		FTD75-8-D.....	174	GES99F-A-C.....	10
CTAP4/0-2-X.....	141	ECF3**-E.....	203	FTD77-8-D.....	174	GES99F-A-C0.....	10
CTAP4/0-4/0-X.....	141	ECF5**-E.....	203	FTD77-10-D.....	174	GES189F-A-C.....	10
CTAPR2/0-2/0-L.....	140	ECF10**-E.....	203	FTD78-8-D.....	174	GES189F-A-C0.....	10
CTAPR2/0-2-L.....	140	ECF10**-X.....	203	FTD78-12-D.....	174	GM-3-Q.....	142
CTAPR2-2-L.....	140	ECFX^*-X.....	206	FTD80-10-TL.....	174	GPL-6-Q.....	137
CTAPR250-2/0-L.....	140	EMS-A-C0.....	66	FTD80-13-TL.....	174	GS2B-E.....	87
CTAPR250-250-L.....	140	<b>F</b>		FTD81-12-C.....	174	GS4H-E.....	87
CTAPR500-2/0-X.....	140	F1.5X1.5LG6.....	184	FTD82-14-C.....	174	GTH-E.....	87
CTAPR500-250-X.....	140	F1.5X2LG6.....	184	<b>G</b>		GTS-E.....	87
CTAPR500-500-X.....	140	F1.5X3LG6.....	184-185	G1.5X1.5LG6.....	185	GUBC500-6.....	141
CWD3LG6.....	191	F1.5X4LG6.....	184	G1.5X2LG6.....	185	<b>H</b>	
CWD4LG6.....	191	F1X1LG6.....	184	G1.5X4LG6.....	185	H000X025H1C.....	102
CXS35-36-C.....	122	F1X3LG6.....	184-185, 187	G1X1.5LG6.....	185	H000X025H1M.....	96
CXS70-14-C.....	122	F1X4LG6.....	184	G1X1LG6.....	185	H000X025H2M.....	96
<b>D</b>		F2.5X3LG6.....	184	G1X1LG6-A.....	192	H000X034H1C.....	102
D1.5X4LG6.....	186	F2X2LG6.....	184	G1X2LG6.....	185	H000X034H1M.....	96
D2X4LG6.....	186	F2X3LG6.....	184	G1X2LG6-A.....	192	H000X034H2C.....	102
DB-C.....	192	F2X4LG6.....	184	G1X3LG6.....	185	H000X034H2M.....	96
DCEFX**-X.....	206	F2X5LG6.....	184	G1X3LG6-A.....	192	H000X044H1C.....	102
DCF3**-X.....	203	F3X2LG6.....	184	G1X4LG6.....	185	H000X044H1M.....	96
DCF5**-X.....	203	F3X3LG6.....	184	G2X1.5LG6.....	185	H000X044H2M.....	96
DCF10**-X.....	203	F3X4LG6.....	184	G2X2LG6.....	185	H000X064H1C.....	102
DCT.....	192	F3X5LG6.....	184	G2X2LG6EMI.....	190	H000X064HPM.....	96
DNF10-250FIB-2K.....	178	F4X3LG6.....	184	G2X3LG6-A.....	192	H000X064HXM.....	96
DNF10-250FIB-L.....	167	F4X4LG6.....	184	G2X3LG6EMI.....	190	H000X084H1C.....	102
DNF10-250FI-L.....	168	F4X5LG6.....	184	G2X4LG6.....	185	H000X084HPM.....	96
DNF14-250-C.....	168	F6X4LG6.....	184	G2X4LG6EMI.....	190	H000X084HXM.....	96
DNF14-250FIB-3K.....	178	F83-12-D.....	175	G2X5LG6.....	185	H000X134HPM.....	96
DNF14-250FIB-C.....	167	F86-25-C.....	175	G3X2LG6.....	185	H000X134HXM.....	96
DNF14-250FIM-2K.....	181	F89-25-L.....	175	G3X3LG6.....	185	H1.5X2LG6.....	188
DNF14-250FIMB-K.....	181	F100X150AJC.....	102	G3X4LG6.....	185	H2X4LG6.....	188
DNF14-250FIM-L Male.....	167	FCC-A-C8.....	81	G3X5LG6.....	185	H100X025H1C.....	102
DNF18-110FIB-C.....	167	FCM1.2-A-C14.....	81	G4X3LG6.....	185	H100X025H1T.....	106
DNF18-111FIB-3K.....	178	FCM1.2-S6-C14.....	81	G4X4LG6.....	185	H100X034H1C.....	102
DNF18-188FIB-3K.....	178	FCM1-A-C14.....	81	G4X5LG6.....	185	H100X034H1T.....	106
DNF18-206FIB-3K.....	178	FCM2-A-C14.....	81	G.5X2LG6.....	185	H100X044H1C.....	102
DNF18-250-C.....	168	FL12X12LG-AV.....	191	G6X4LG6.....	185	H100X044H1T.....	106
DNF18-250FIB-3K.....	178	FL25X25LG-AV.....	191	G.75X2LG6.....	185	H100X064H1C.....	102
DNF18-250FIB-C Female.....	167	FL50X50LG-AV.....	191	GACB-2.....	136	H200X025H1T.....	106
DNF18-250FIM-2K.....	181	FS2X2LG6NM.....	186	GB2B0304TPI-1.....	131, 133, 135	H200X034H1T.....	106
DNF18-250FIMB-K.....	181	FSD73-8-D.....	173	GB2B0306TPI-1.....	131	H200X044H1T.....	106
DNF18-250FIM-L Male.....	167	FSD74-8-D.....	173	GB2B0312TPI-1.....	131	H200X064H1T.....	106
DNF14250FIBX-2K.....	179	FSD75-8-D.....	173	GB2B0514TPI-1.....	131	HBN2-T.....	84
DNF18206FIBX-2K.....	179	FSD75-10-D.....	173	GB4B0612TPI-1.....	131, 133	HC1.5LG6.....	188
DNF18250FIBX-2K.....	179	FSD75-10-D.....	173	GB4B0624TPI-1.....	131	HC2LG6.....	188
DNFR14-250B-L.....	169	FSD76-8-D.....	173	GB4B1028TPI-1.....	131	HCMP06B12-M20.....	82
DNFR14250FIB-KD.....	179	FSD76-10-D.....	173	GCC6X6250-1/0.....	139	HDW1/4-A-KT.....	135
DNFR18205FIB-KD.....	179	FSD77-6-D.....	173	GCC6X6500-250.....	139	HSEC0.5-X.....	14
DNFR18206FIB-KD.....	179	FSD77-8-3K2.....	182	GCE1/0-1/0.....	138	HSEC0.8-X.....	14
DNFR18250FIB-KD.....	179	FSD77-8-K.....	182	GCE250-1/0.....	138	HST0.4-48-5Y.....	17
DPF14-250FIB-3K.....	180	FSD77-10-D.....	173	GCE250-250.....	138	HST0.8-6-XY.....	17
DRD22LG6.....	189	FSD77-12-D.....	173	GCE500-1/0.....	138	HST0.8-48-5Y.....	17
DRD33LG6.....	189	FSD78-8-2KD0.....	182	GCE500-250.....	138	HST1.1-48-5Y.....	17
DRD44LG6.....	189	FSD78-8-D.....	173	GE85-C.....	10	HST1.5-48-5Y.....	17
DS1.....	14	FSD78-8-DSL0.....	175	GE128-C.....	10	HST2.0-48-2Y.....	17
DS5.....	14	FSD78-10-D.....	173	GE192-L.....	10	HST3.0-48-2.....	17

## Index by Part Number

HSTT06-C	15
HSTT09-48-Q	15
HSTT12-C	15
HSTT19-48-Q	15
HSTT25-48-Q	15
HSTT25-C	15
HSTT38-48-Q	15
HSTT38-C	15
HSTT50-48-5	15
HSTT50-C	15
HSTT75-48-5	15
HSTT75-C	15
HSTT100-48-5	15
HSTT100-C	15
HSTT150-48-5	15
HSTT150-C	15
HSTT200-48-5	15
HSTT200-L	15
HSTT300-L	15
HSTTA25-48-TL	16
HSTTA50-48-5	16
HSTTA75-48-5	16
HSTTA100-48-5	16
HSTTA150-48-5	16
HSTTA150-48-Q	16
HSTTRA50-48-5	16
HTCT2-2-1	136
HTCT250-2-1	132, 136
HTDU6R-E	150
HV9150-C0	62
<b>I</b>	
ICFC3**-X	203
ICFC5**-X	203
ICFC10**-X	203
ICFXA**-X	206
<b>J</b>	
JB1D**-A	213
JB1IW-A	213
JBP1D**	213
JBP1DIW	213
JBP2IW	213
JBP2SIW	213
JBX3510**-A	213
JN218-216-C	172
JN314-412-C	172
JN418-212-C	172
<b>K</b>	
KP-FSD2	175
<b>L</b>	
LAB500-12-24R	120
LAB600-12-24	120
LAB750-12-24R	120
LAM2A1/0-14-6Y	123
LAM2A250-38-6Y	123
LAM2A350-12-6Y	123
LAM2A600-12-6Y	123
LAMA1/0-14-QY	123
LAMA2/0-14-QY	123
LAMA2-14-QY	123
LAMA6-14-QY	123
LAMA250-56-QY	123
LAMA350-38-QY	123
LC3-A-C8	81
LC5-A-C8	81
LC10-A-L8	81
LCA1/0-14-X	110
LCA1/0-38-X	110
LCA1/0-56-X	110
LCA1-14-E	110
LCA1-38-E	110

LCA2/0-12-X	110
LCA2/0-38-X	110
LCA2/0-56-X	110
LCA2-12-Q	110
LCA2-14-Q	110
LCA2-38-Q	110
LCA2-56-Q	110
LCA3/0-38-X	110
LCA4/0-12-X	110
LCA4/0-38-X	110
LCA4-14-L	110
LCA4-38-L	110
LCA4-56-L	110
LCA6-10-L	110
LCA6-14-L	110
LCA6-38-L	110
LCA8-10-L	110
LCA8-14-L	110
LCA8-38-L	110
LCA10-10-L	110
LCA250-12-X	110
LCA250-38-X	110
LCA350-12-X	110
LCA400-12-6	110
LCA500-12-6	110
LCA600-12-6	110
LCAF4/0-12-X	111
LCAN2/0-38-X	111
LCAN3/0-56-X	111
LCAN4/0-38-X	111
LCAN250-38-X	111
LCAN350-38-X	111
LCAX1/0-14-X	117
LCAX1/0-38-X	117
LCAX1/0-56-X	117
LCAX2/0-38-X	117
LCAX2/0-56-X	117
LCAX2-14-E*	117
LCAX2-38-E*	117
LCAX2-56-E*	117
LCAX3/0-38-X	117
LCAX4/0-12-X	117
LCAX4/0-14-X	117
LCAX4/0-38-X	117
LCAX4/0-56-X	117
LCAX4-14-L	117
LCAX6-14-L	117
LCAX250-12-X	117
LCAX250-38-X	117
LCAX350-12-6	117
LCAX350-38-6	117
LCAX450-12-6	117
LCAX500-12-6	117
LCAX750-12-3	117
LCB4/0-12-X	112
LCC2-14A-Q	114
LCC4/0-12W-X	115
LCC4/0-12-X	114
LCC6-14A-L	114
LCC6-14AW-L	115
LCC6-14JAW-L	115
LCC6-38D-L	114
LCC8-10AW-L	115
LCC10-14AW-L	115
LCC250-12W-X	115
LCC350-12W-X	115
LCC350-12-X	114
LCC400-12-6	114
LCC400-12W-6	115
LCC500-12-6	114
LCC500-12W-6	115
LCC600-12-6	114

LCC600-12W-6	115
LCC750-12-6	114
LCCX2/0-38D-X	119
LCCX2-14A-E*	119
LCCX4/0-12-X	119
LCCX4/0-38D-X	119
LCCX4-14A-L	119
LCCX6-14A-L	119
LCCX300-12-6	119
LCCX350-12-6	119
LCCX450-12-6	119
LCCX500-12-6	119
LCCX650-12-6	119
LCD2-14A-Q	113
LCD4-14AF-L	113
LCD4-14A-L	113
LCD6-10A-L	113
LCD6-14AF-L	113
LCD6-14A-L	113
LCD6-14D-L	113
LCD8-10A-L	113
LCD8-14A-L	113
LCD10-10A-L	113
LCD10-14A-L	113
LCDX2-14A-E*	118
LCDX4/0-14A-X	118
LCDX4-14A-L	118
LCDX6-14A-L	118
LCDX8-14A-L	118
LD3	202
LD3**6-A	203
LD3**8-A	203
LD3**10-A	203
LD5	202
LD5**6-A	203
LD5**8-A	203
LD5**10-A	203
LD10	202
LD10**6-A	203
LD10**8-A	203
LD10**10-A	203
LDPH3	202
LDPH3**6-A	206
LDPH3**8-A	206
LDPH3**10-A	206
LDPH5	202
LDPH5**6-A	206
LDPH5**8-A	206
LDPH5**10-A	206
LDPH10	202
LDPH10**6-A	206
LDPH10**8-A	206
LDPH10**10-A	206
LHMS-S6-D	71
LHMS-S10-D	71
LIAC4-22-C	142
LPMS-S8-C	69
LWC25-A-C	80
LWC25-A-C14	80
LWC38-A-C14	80
LWC38-A-C20	80
LWC50-A-L	80
LWC50-A-L20	80
LWC75-H25-L14	80
<b>M</b>	
M300X050Y6C	101
M300X050Y6M	99
M300X050Y7M	99
MACC25-A-C	79
MACC25-A-D	79
MACC62-A-D	79
MC50X75IG2	188

MCMS12-P-C	72
MCMS25-P-C	72
MCMS30-P-C	72
MEC100-2PV-C	82
MEC100-90-2PV-C	82
MEC100-90-PV-C	82
MEC125-4PV-C	82
MEHT187	108
METS3-X	108
METS4-X	108
ML1/0-LY	121
ML4-CY	121
MLT1S-CP	153, 155, 157-158
MLT2.7H-LP	153
MLT2.7S-CP	153
MLT2H-LP316	153
MLT2S-CP	153
MLT4DEH15-Q316	22
MLT4DSH-Q316	22
MLT4H-LP	153
MLT4S-CP	153
MLT4SH-LP316	153
MLT6SH-LP316	153
MLT6DEH15-Q316	22
MLT6DSH-Q316	22
MLT6H-LP	153
MLT6H-LP316	153
MLT6S-CP	153
MLT8DEH15-Q316	22
MLT8DSH-Q316	22
MLT8H-LP316	153
MLT8S-CP	153
MLTC2H-LP316	154
MLTC4H-LP316	153-154
MLTC6H-LP316	154
MLTC8H-LP316	154
MLTC10H-LP316	154
MLTFC2H-LP316	154
MLTFC4EH-LP316	154
MLTFC4H-LP316	154
MLTFC4SH-LP316	154
MLTFC6H-LP316	154
MLTFC8H-LP316	154
MMP350H-MAL	108
MMP350-M	108
MMP350-M316	108
MMP350W38-M316	108
MP75	93
MP100	93
MP100-IB	93
MP200	92
MP200-KIT	92
MP250-C	76
MP250W175-C	76
MP300	92
MP300-ACS	92
MP350-C	76
MP-ACS-1	92-93
MP-BATT	92
MP-CASE	92
MS4W75T30-Q6	22
MS6W75T30-Q6	22
MS8W50T15-L4	156
MS8W75T30-Q6	22
MS10W50T15-L4	156
MS10W75T30-Q6	22
MS12W75T30-Q6	22
MS14W75T30-Q6	22
MSCNW38T15-QR6	156
MSW50T15-CR4	156
MTP2S-E6-C	70
MTP3H-E6-C	70



## Index by Part Number

Product Showcase

Abrasion Protection

Cable Cleats

Cable Ties

Cable Tie Accessories

Cable Tie Tools

Identification Products

Power Connectors

Grounding Connectors

Safety Solutions

Stainless Steel Ties

Terminals

Wiring Duct

Part Number Index

MTP3S-E6-C.....	70	PLC2H-S25-TL0.....	48	PLT2S-C702Y.....	41	PLT.6SM-M30.....	35
MTP4S-E6-C.....	70	PLC2S-S6-C0.....	48	PLT2S-C6120.....	38	PLT7LH-C30.....	35
MTP5H-E6-C.....	70	PLC2S-S10-C.....	47	PLT2S-M100.....	40	PLT7LH-C6120.....	38
MTP6H-E10-C.....	70	PLC2S-S10-C0.....	48	PLT2S-M109.....	39	PLT7LH-L.....	31
MTPC3H-E10-C39.....	70	PLC2S-S10-M30.....	48	PLT2S-M300.....	36	PLT7LH-L0.....	33
<b>N</b>		PLC3S-S10-C.....	47	PLT2S-M6120.....	38	PLT.7M-C.....	30, 55-56
N050X075C1M.....	98	PLC4S-S10-C0.....	48	PLT3H-L0.....	33	PLT.7M-M0.....	32
N100X075C1M.....	98	PLD-57.....	147	PLT3H-L76.....	42	PLT8H-C30.....	35
N100X125C1M.....	98	PLDC1.5EH-C350.....	64	PLT3H-L86.....	44	PLT8H-L.....	31
NC1WH6.....	187	PLDC2.5EH-C350.....	64	PLT3H-L186.....	44	PLT8H-L0.....	33
NC2WH6.....	187	PLF1MA-C.....	53	PLT3H-TL30.....	35	PLT8LH-C6120.....	38
NC3WH6.....	187	PLF1M-C.....	53	PLT3H-TL100.....	40	PLT9LH-C30.....	35
NC4WH6.....	187	PLM4S-D0.....	53	PLT3I-C.....	30	PLT9LH-L.....	31
NE1X1WH6.....	187	PLP1S-M.....	52	PLT3I-C0.....	32	PLT9LH-L0.....	33
NE1X2WH6.....	187	PLP2S-M0.....	52	PLT3I-M0.....	32	PLT12EH-C.....	31
NE1X3WH6.....	187	PLST4HS25-TL300.....	63	PLT3I-M30.....	35	PLT13H-Q.....	31
NE1X4WH6.....	187	PLT1.5I-C.....	30	PLT3S-C.....	30	PLT13H-Q0.....	33
NE2X1WH6.....	187	PLT1.5I-C0.....	32	PLT3S-C0.....	33	PLW1P1M-D30.....	50
NE2X2WH6.....	187	PLT1.5I-C6120.....	38	PLT3S-C76.....	42	PLW1P1SB-D.....	49
NE2X2WH6-A.....	192	PLT1.5I-M100.....	40	PLT3S-C86.....	44	PLW1P1S-D30.....	50
NE2X4WH6.....	187	PLT1.5I-M6120.....	38	PLT3S-C186.....	44	PM2H25-C.....	73
NE3X4WH6.....	187	PLT1.5M-C.....	30, 35	PLT3S-C702Y.....	41	PN10-8F-L.....	165
NE3X5WH6.....	187	PLT1.5M-C0.....	32	PLT3S-C6120.....	38	PN10-8R-L.....	161
NE4X3WH6.....	187	PLT1.5M-C71.....	43	PLT3S-M.....	30	PN10-10F-L.....	165
NE4X4WH6.....	187	PLT1.5M-M.....	30	PLT3S-M0.....	33	PN10-10R-L.....	161
NNC50X75LG2.....	187	PLT1.5M-M30.....	35	PLT3S-M100.....	40	PN10-14R-L.....	161
NNC75X75WH2.....	187	PLT1.5M-XMR.....	89	PLT3S-M109.....	39	PN10-38R-L.....	161
NR1-M.....	192	PLT1.5M-XMR0.....	89	PLT3S-M6120.....	38	PN14-6F-C.....	165
<b>O</b>		PLT1.5M-XMR30.....	89	PLT4H-L.....	31	PN14-6R-C.....	161
OCFC10**X.....	203	PLT1M-C.....	30, 32	PLT4H-L0.....	33	PN14-8F-C.....	165
OCFX^**X.....	206	PLT1M-C0.....	32	PLT4H-L76.....	42	PN14-8R-C.....	161
OCFX3**X.....	203	PLT1M-C71.....	43	PLT4H-L86.....	44	PN14-10F-C.....	165
OCFX5**X.....	203	PLT1M-C76.....	42	PLT4H-L186.....	44	PN14-10R-3K.....	176
OCFX10**X.....	203	PLT1M-C86.....	44	PLT4H-TL0.....	33	PN14-10R-C.....	161
<b>P</b>		PLT1M-C186.....	44	PLT4H-TL0/147.....	33	PN14-14R-C.....	161
P6-14R-E.....	165	PLT1M-C702Y.....	41	PLT4H-TL30.....	35	PN18-6R-C.....	161
P8-14R-Q.....	165	PLT1M-C6120.....	38	PLT4H-TL69.....	37	PN18-8F-C.....	165
P10-10RHT6-L.....	164	PLT1M-M30.....	35	PLT4H-TL76.....	42	PN18-8R-C.....	161
P10-10R-L.....	164	PLT1M-M69.....	37	PLT4H-TL100.....	40	PN18-10R-3K.....	176
P10-14R-L.....	164	PLT1M-M76.....	42	PLT4H-TL300.....	36	PN18-10R-C.....	161
P14-10R-C.....	164	PLT1M-M100.....	40	PLT4H-TL6120.....	38	PNF10-10R-2K.....	176
P14-14R-C.....	164	PLT1M-M300.....	36	PLT4I-C.....	30	PNF10-14R-2K.....	176
PAT1.5M4.0.....	88	PLT1M-M6120.....	38	PLT4I-C0.....	32	PNF14-8LF-3K.....	177
PAT1M4.0.....	88	PLT1M-XMR.....	89	PLT4I-M30.....	35	PNF14-10R-3K.....	176
PBDCT.....	192	PLT1M-XMR0.....	89	PLT4S-C.....	30	PNF18-10R-3K.....	176
PBMS-H25-C.....	73	PLT1M-XMR30.....	89	PLT4S-C0.....	33	PP2S-S10-X.....	74
PBMS-H25-M.....	73	PLT1S-M30.....	35	PLT4S-C76.....	42	PP2S-S12-X.....	74
PBMS-H25-M0.....	73	PLT2.5S-C0.....	33	PLT4S-C86.....	44	PPF2S-S25-V69.....	74
PBMS-H25-M30.....	73	PLT2.5S-C6120.....	38	PLT4S-C186.....	44	PPTS.....	87
PCSB2/0-2-12.....	125	PLT2.5S-M6120.....	38	PLT4S-C6120.....	38	PRT2EH-C100.....	46
PCSB2/0-2S-6.....	124	PLT2H-L0.....	33	PLT4S-M.....	30	PRT4S-C.....	45
PCSB2/0-3S-6Y.....	124	PLT2H-TL30.....	35	PLT4S-M0.....	33	PRT5EH-C0.....	46
PCSB4-2-12Y.....	125	PLT2H-TL100.....	40	PLT4S-M69.....	37	PRT5EH-C30.....	46
PCSB4-2S-12Y.....	124	PLT2I-C.....	30	PLT4S-M100.....	40	PRT5EH-C100.....	46
PCSB4-3S-12Y.....	124	PLT2I-C0.....	32	PLT4S-M109.....	39	PRT5EH-Q0.....	46
PCSB250-2-6Y.....	125	PLT2I-C30.....	35	PLT4S-M300.....	36	PRT6EH-C100.....	46
PCSB250-2S-6Y.....	124	PLT2I-C76.....	42	PLT4S-M6120.....	38	PRT6EH-Q0.....	46
PCSB250-3-6Y.....	125	PLT2I-C86.....	44	PLT5EH-NB-C0.....	34	PRT8EH-C100.....	46
PCSLSH-B-CR.....	23, 155	PLT2I-C186.....	44	PLT5EH-Q0.....	34	PRT8EH-Q0.....	46
PCSSH-B-CR.....	23, 155	PLT2I-M76.....	42	PLT5H-C30.....	35	PRWP1.5S-D.....	51
PDM4.0.....	88	PLT2I-M300.....	36	PLT5H-L.....	31	PRWP1.5S-D0.....	51
PES400.....	108	PLT2M-C.....	30, 32-33, 42	PLT5H-L0.....	33	PS12-L.....	171
PHM3.....	88	PLT2M-C0.....	32	PLT5S-C.....	30	PSL-1.....	149
PISR250-1.....	124	PLT2M-M.....	30	PLT5S-C0.....	33	PSL-1A.....	149
PLB2S-C0.....	64	PLT2M-M0.....	32	PLT5S-M30.....	35	PSL-8.....	150
PLB2S-M30.....	64	PLT2M-M30.....	35	PLT6EH-Q0.....	34	PSL-8BL.....	150
PLB3S-M30.....	64	PLT2S-C.....	30	PLT6H-C30.....	35	PSL-8BU.....	150
PLB4H-TL0.....	64	PLT2S-C0.....	33	PLT6H-L.....	31	PSL-8GR.....	150
PLB4S-M0.....	64	PLT2S-C71.....	43	PLT6H-L0.....	33	PSL-8OR.....	150
PLC1M-S4-C.....	47	PLT2S-C76.....	42	PLT6LH-L.....	31	PSL-8PU.....	150
		PLT2S-C86.....	44	PLT6LH-L0.....	33	PSL-8YL.....	150
		PLT2S-C186.....	44	PLT.6SM-C.....	30	PSL-KT-CONA.....	150



## Index by Part Number

PSL-MLDH-X.....	149	PW150FR-L20Y.....	8	PWBTB6BL.....	197	S050X075YAJ.....	107
PSL-PK-EA.....	150	PWB2X4.....	194	PWBTB8BL.....	197	S050X125VA1Y.....	105
PST-1.....	147	PWB2X6.....	194	PWBTB12BL.....	197	S050X125VAC.....	101
PST-FO.....	147	PWB2X8.....	194	PWBTB12EZ.....	193	S050X125VAM.....	95
PST-FOBLNK.....	147	PWB2X12.....	194	PWBTB18BL.....	197	S050X125VATY.....	105
PTH.....	87	PWB2X12EZ.....	193	PWBTB18EZ.....	193	S050X125YAJ.....	107
PTR-CLN.....	92, 93	PWB2X18.....	194	PWBTB24BL.....	197	S050X150VA1Y.....	105
PTS.....	87	PWB2X18EZ.....	193	PWBTB24EZ.....	193	S050X150VAC.....	101
PUM-049-M30.....	73	PWB2X24.....	194	PWBTL4BL.....	199	S050X150VAM.....	95
PUM-071-M30.....	73	PWB2X24EZ.....	193	PWBTL6BL.....	199	S050X150VATY.....	105
PV6-14R-X.....	163	PWB4X4.....	194	PWBTL8BL.....	199	S050X150YAJ.....	107
PV6-14RX-X.....	163	PWB4X6.....	194	PWBTL12BL.....	199	S075X125VATY.....	105
PV8-10R-QY.....	163	PWB4X8.....	194	PWBTL12PG.....	193	S075X125YAJ.....	107
PV8-14R-QY.....	163	PWB4X12.....	194	PWBTL18BL.....	199	S075X150VAC.....	101
PV10-6F-L.....	166	PWB4X12EZ.....	193	PWBTL18PG.....	193	S075X150VATY.....	105
PV10-8F-L.....	166	PWB4X18.....	194	PWBTL24BL.....	199	S075X150VAC.....	101
PV10-8LFB-2K.....	178	PWB4X18EZ.....	193	PWBTSBEZ.....	197	S100X075VAC.....	101
PV10-8LF-L.....	166	PWB4X24.....	194	PWBWFNBL.....	198	S100X075VAM.....	95
PV10-8RB-2K.....	177	PWB4X24EZ.....	193	PWBWFWBL.....	198	S100X075YAJ.....	107
PV10-8R-L.....	162	PWB6X6.....	194	PWBWFWEZ.....	193	S100X125VAC.....	101
PV10-10F-L.....	166	PWB6X8.....	194	PWBWMNBL.....	197	S100X125VAM.....	95
PV10-10LF-L.....	166	PWB6X12.....	194	PWBWMWBL.....	197	S100X125VATY.....	105
PV10-10RB-2K.....	177	PWB6X12EZ.....	193	PWBWMWEZ.....	193	S100X125YAJ.....	107
PV10-10R-L.....	162	PWB6X18.....	194	PWMS-H25-C.....	72	S100X150VA1Y.....	105
PV10-14RB-2K.....	177	PWB6X18EZ.....	193	PWMS-H25-M.....	72	S100X150VAC.....	101
PV10-14R-L.....	162	PWB6X24.....	194	PWMS-H25-M0.....	72	S100X150VAM.....	95
PV10-38RB-2K.....	177	PWB6X24EZ.....	193	<b>Q</b>		S100X150VATY.....	105
PV10-38R-L.....	162	PWBCB4BL.....	197	QB-KIT2.....	83	S100X150VBTY.....	105
PV10-56RB-2K.....	177	PWBCB4EZ.....	193	QB-MOUNT-L.....	83	S100X150YAJ.....	107
PV10-56R-L.....	162	PWBCB6BL.....	197	QB-TILE.....	83	S100X150YBJ.....	107
PV14-6F-C.....	166	PWBCB6EZ.....	193	<b>R</b>		S100X225VA1Y.....	105
PV14-6LF-C.....	166	PWBCB8BL.....	197	R100X075V1M.....	94	S100X225VAC.....	101
PV14-6R-C.....	162	PWBCB8EZ.....	193	R100X125V1M.....	94	S100X225VAM.....	95
PV14-8F-C.....	166	PWBCB12BL.....	197	R100X125V1C.....	100	S100X225VATY.....	105
PV14-8LF-C.....	166	PWBCB18BL.....	197	R100X150V1C.....	100	S100X225YAJ.....	107
PV14-8RB-3K.....	177	PWBCB24BL.....	197	R100X150V1M.....	94	S100X250VATY.....	105
PV14-8R-C.....	162	PWBDOKBL.....	198	R100X150V1T.....	104	S100X400VA1Y.....	105
PV14-10F-C.....	166	PWBDOKEZ.....	193	R100X225V1C.....	100	S100X400VAC.....	101
PV14-10RB-3K.....	177	PWBWD2BL.....	199	R100X225V1M.....	94	S100X400VAM.....	95
PV14-10R-C.....	162	PWBWD2PG.....	193	R100X225V1T.....	104	S100X400VATY.....	105
PV14-14RB-3K.....	177	PWBWD4BL.....	199	R150X150V1T.....	104	S100X400YAJ.....	107
PV14-14R-C.....	162	PWBWD4PG.....	193	R200X225V1T.....	104	S100X650VAM.....	95
PV14-56RB-2K.....	177	PWBWD6BL.....	199	RAEFX**X.....	206	S100X650VATY.....	105
PV14-P47-C.....	170	PWBWD6PG.....	193	RAFC3**X.....	203	S100X650YAJ.....	107
PV18-6F-CY.....	166	PWBIB2EZ.....	193	RAFC5**X.....	203	S150X150VATY.....	105
PV18-6LFB-3K.....	178	PWBIB4EZ.....	193	RAFC10**X.....	203	S150X225VATY.....	105
PV18-6RB-3K.....	177	PWBIB6EZ.....	193	RAFCB11-S6-C20.....	74	S150X400VATY.....	106
PV18-6R-CY.....	162	PWBPF2X4.....	196	RAFCB12-S6-C20.....	74	S200X150VATY.....	106
PV18-8F-CY.....	166	PWBPF2X6.....	196	RAFX**X.....	206	S200X150YAJ.....	107
PV18-8LFB-3K.....	178	PWBPF2X8.....	196	RAMH-S6-D.....	71	S200X225VA1Y.....	106
PV18-8RB-3K.....	177	PWBPF2X12.....	196	RAMS-S3-M.....	71	S200X225VATY.....	106
PV18-8R-CY.....	162	PWBPF2X18.....	196	RER1.25-S6-X.....	84	S200X250YAJ.....	107
PV18-10F-CY.....	166	PWBPF2X18EZ.....	193	RER.5-S6-X.....	84	S200X250VATY.....	106
PV18-10RB-3K.....	177	PWBPF2X24.....	196	RER.75-S6-X.....	84	S200X400VA1Y.....	106
PV18-10R-CY.....	162	PWBPF4X4.....	196	RGEJ1024PFY.....	134	S200X400VATY.....	106
PV18-14RB-3K.....	177	PWBPF4X6.....	196	RGEJ1024URT.....	134	S200X400YAJ.....	107
PV18-38RB-2K.....	177	PWBPF4X8.....	196	RGRB19U.....	132	S200X650VA1Y.....	106
PV18-P47-CY.....	170	PWBPF4X12.....	196	RGS134-1Y.....	133	S200X650VATY.....	106
PW50FR-T20Y.....	8	PWBPF4X18.....	196	RGS134B48-1.....	133	S200X650YAJ.....	107
PW50FR-TY.....	8	PWBPF4X18EZ.....	193	RGS13451-1.....	133	SACS50-T100.....	75
PW50F-T.....	8	PWBPF4X24.....	196	RHER4BL.....	104	SBC1/0-L.....	121
PW50F-T20.....	8	PWBPF6X6.....	196	RMEH4BL.....	103-104	SBC2/0-Q.....	121
PW75F-C.....	8	PWBPF6X8.....	196	RMER4BL.....	103	SBC2-C.....	121
PW75F-C20.....	8	PWBPF6X12.....	196	RT2HT.....	158	SBC4S-C.....	121
PW75FR-C20Y.....	8	PWBPF6X18.....	196	<b>S</b>		SBC6S-C.....	121
PW75FR-CY.....	8	PWBPF6X18EZ.....	193	S000X100VAM.....	94	SBC8-C.....	121
PW100F-C.....	8	PWBPF6X24.....	196	S000X150VAM.....	94	SBC250-Q.....	121
PW100F-C4.....	8	PWBSPCEZ.....	197	S050X075VAM.....	105	SC6-L.....	116
PW100F-C20.....	8	PWBSPJ2BL.....	193, 198	S050X075VA1Y.....	105	SCS6-L.....	116
PW100FR-C20Y.....	8	PWBSPJ4BL.....	193, 198	S050X075VAC.....	101	SD2EMI.....	189
PW100FR-CY.....	8	PWBSPLEZ.....	193	S050X075VAM.....	95	SD2H6.....	192
PW150F-L.....	8	PWBTB4BL.....	197	S050X075VATY.....	105	SD3EMI.....	189

## Index by Part Number

Product Showcase

Abrasion Protection

Cable Cleats

Cable Ties

Cable Tie Accessories

Cable Tie Tools

Identification Products

Power Connectors

Grounding Connectors

Safety Solutions

Stainless Steel Ties

Terminals

Wiring Duct

Part Number Index

SD3H6.....	192	T25FR-C20Y.....	9	T70DW8.....	212	TFC10**-X.....	203
SD4EMI.....	189	T25FR-CY.....	9	T70DW10.....	212	TFX^**-X.....	206
SD4H6.....	192	T25N-C.....	9	T70EC**.....	212	TM1S6-C.....	67
SE12PFR-MR0.....	12	T25N-C0.....	9	T70EE**.....	212	TM2S6-C.....	67
SE12PFR-TR0.....	12	T25R-CY.....	9	T70FH2.....	213	TM2S8-C.....	67
SE12P-TR0.....	12	T25T-L.....	9	T70FH4.....	213	TM2S8-C0.....	67
SE25PFR-MR0.....	12	T38F-C.....	8	T70FV2.....	213	TM2S8-C71.....	43
SE25PFR-TR0.....	12	T38F-C0.....	9	T70FV4.....	213	TM2S8-C76.....	43
SE25PFR-TR8.....	12	T38FR-C20Y.....	9	T70HB3-X.....	212	TM2S8-C86.....	45
SE25P-MR0.....	12	T38F-TL.....	8	T70IC**.....	212	TM2S8-C186.....	45
SE25P-MR8.....	12	T38N-C0.....	9	T70OC**.....	212	TM3S8-C.....	67
SE25P-MR10.....	12	T38N-TL.....	9	T70P.....	213	TM3S8-C0.....	67
SE25P-TR0.....	12	T38P-C0.....	9	T70PG.....	213	TM3S8-C76.....	43
SE25TC-C.....	13	T38T-L.....	9	T70RA**.....	212	TM3S8-C86.....	45
SE38N-C.....	14	T038X000BPM-BK.....	97	T70T**.....	212	TM3S8-C186.....	45
SE38PFR-MR0.....	12	T038X000BXM-BK.....	97	T70TD.....	212	TM3S10-C.....	67
SE38PFR-TR0.....	12	T038X000BYM-WH.....	97	T70TR.....	212	TM3S10-C0.....	67
SE38P-MR0.....	12	T038X000FJM-BK.....	100	T70WC2.....	213	TM3S10-C76.....	43
SE38PSC-TR0.....	13	T038X000VPM-BK.....	97	T75F-C.....	9	TM3S10-C86.....	45
SE38P-TR0.....	12	T038X000VXM-BK.....	97	T75F-C0.....	9	TM3S10-C186.....	45
SE50P-CR0.....	12	T038X000YKM-BK.....	97	T75FR-C20Y.....	9	TM3S10-M.....	67
SE50P-DR0.....	12	T45B**8.....	209	T75FR-CY.....	9	TM3S25-C.....	67
SE50PFR-CR0.....	12	T45B**10.....	209	T75T-X.....	9	TM3S25-C0.....	67
SE50PFR-DR0.....	12	T45C**10.....	209	T075X000BPM-BK.....	97	TM3-X2-C0Y.....	69
SE50PSC-CR0.....	13	T45CC**-X.....	209	T075X000BXM-BK.....	97	TMEH3S8-D350.....	68
SE50PS-CLR0.....	13	T45CIW8.....	209	T075X000BYM-WH.....	97	TMEH3S10-D350.....	68
SE50TC-L.....	13	T45DW8.....	209	T075X000C1M-BK.....	98	TMEH4S8-D350.....	68
SE75N-L.....	14	T45DW10.....	209	T075X000VPM-BK.....	97	TMEH4S10-D350.....	68
SE75P-CR0.....	12	T45EC**.....	209	T075X000VXM-BK.....	97	TMEH-S8-Q0.....	68
SE75P-DR0.....	12	T45EE**.....	209	T075X000YKM-BK.....	97	TMEH-S10-C0.....	68
SE75PFR-CR0.....	12	T45HDB.....	209	T100F-C.....	9	TMEH-S10-C100.....	68
SE75PFR-DR0.....	12	T45HEGB.....	209	T100F-C0.....	9	TMEH-S10-Q0.....	68
SE75PSC-CR0.....	13	T45IC**.....	209	T100N-C0.....	9	TMEH-S25-C0.....	68
SE75PS-CR0.....	13	T45OC**.....	209	T100P-C0.....	9	TMEH-S25-Q0.....	68
SE88TC-L.....	13	T45RA**.....	209	T100X000BPM-BK.....	97	TMEH-X2-L0Y.....	69
SE100PS-CR0.....	13	T45T**.....	209	T100X000BQM-WH.....	97	TMSTHS11-D0.....	72
SE125PFR-TR0.....	12	T45WC.....	213	T100X000BSM-WH.....	97	TMSTHS16-D0.....	72
SE125P-LR0.....	12	T50F-C.....	8	T100X000BUM-BK.....	97	TNR.....	192
SE125PS-LQR0.....	13	T50F-C0.....	9	T100X000BWM-WH.....	97	TRBSK.....	135
SE125P-TR0.....	12	T50F-C4Y.....	8	T100X000BXM-BK.....	97	<b>U</b>	
SE125P-TR8.....	12	T50FR-C20Y.....	9	T100X000BYM-WH.....	97	UCIB1-V316.....	23
SE150N-Q.....	14	T50FR-CY.....	9	T100X000C1M-BK.....	98	UCSQ1-V316.....	23
SE150PFR-TR0.....	12	T50FR-TLY.....	9	T100X000MPM-BK.....	97	UCTH1-V316.....	23
SE150P-TR0.....	12	T50F-TL.....	8	T100X000MXM-BK.....	97	UGB-B-SO.....	132
SE175N-Q.....	14	T50F-TL0.....	9	T100X000VPM-BK.....	97	UGB-IN-SO.....	132
SE175P-TR0.....	12	T50F-TL4Y.....	8	T100X000VXM-BK.....	97	<b>V</b>	
SE200PS-LR0.....	13	T50F-X0.....	9	T100X000YKM-BK.....	97	VS2-AVT-11B.....	146
SE300N-Q.....	14	T50N-TL0.....	9	T150X000BPM-BK.....	97	VS2-AVT-11F.....	146
SGABM20-A-C.....	78	T50P-C0.....	9	T150X000BQM-WH.....	97	VS2-AVT-31B.....	146
SGABM20-AT-C0.....	78	T50R-CY.....	9	T150X000BSM-WH.....	97	VS2-AVT-31F.....	146
SGABM20-AV-C300.....	78	T50R-TLY.....	9	T150X000BUM-BK.....	97	VS2-AVT-3PB-08.....	144
SGABM25-A-C.....	78	T50T-Q.....	9	T150X000BWM-WH.....	97	VS2-AVT-RL.....	146
SGABM25-AT-C0.....	78	T050X000BPM-BK.....	97	T150X000BXM-BK.....	97	VS2-CABLE-02.....	146
SGABM25-AV-C300.....	78	T050X000BXM-BK.....	97	T150X000BYM-WH.....	97	VS2-CABLE-04.....	146
SGABM30-AV-C300.....	78	T050X000BYM-WH.....	97	T150X000MPM-BK.....	97	VS2-CABLE-08.....	146
SGTA1S8-C.....	69	T050X000C1M-BK.....	98	T150X000MXM-BK.....	97	VS2-CABLE-16.....	146
SP1-4L-C.....	134	T050X000VPM-BK.....	97	T150X000VPM-BK.....	97	VS2-CABLE-20.....	146
SP2-2/0-Q.....	142	T050X000VXM-BK.....	97	T150X000VXM-BK.....	97	VS2-CABLE-30.....	146
SP2-2-C.....	142	T050X000YKM-BK.....	97	T150X000YKM-BK.....	97	VS2-NET.....	146
SP2-2L-C.....	142	T62F-C.....	9	T400X000Y81.....	107	VS-AVT-C02-L03.....	144, 148-149
SP2-4/0-Q.....	142	T62N-C0.....	9	T400X000YP1.....	107	VS-AVT-C08-L10.....	144, 148
ST2MT.....	158	T62T-Q.....	9	T400X000YS1.....	107	VS-CKP1K4/0-500.....	146
<b>T</b>		T70B**6.....	212	T400X000YU1.....	107	VS-CKP4-000.....	146
T12FR-CY.....	9	T70B**8.....	212	TA1S8-C.....	69	VS-CKP4-6.....	146
T12T-C.....	9	T70B**10.....	212	TA1S8-M.....	69	<b>W</b>	
T024X000BPM-BK.....	97	T70BC**-X.....	212	TA1S8-M0.....	69	WR2-C.....	191
T024X000FJM-BK.....	100	T70C**6.....	212	TDP43HET.....	103		
T25F-C.....	8	T70C**8.....	212	TDP43ME.....	103		
T25F-C0.....	9	T70C**10.....	212	TDP43ME-KIT.....	103		
T25F-C3Y.....	8	T70CC**-X.....	212	TDP46HET.....	103		
T25F-C10.....	8	T70DB-X.....	212	TFC3**-X.....	203		
T25F-M.....	8	T70DW6.....	212	TFC5**-X.....	203		



CUSTOMER CENTER



SALES OFFICE



MANUFACTURING



WAREHOUSE



NON-SALES OFFICE

NA

NORTH AMERICA  
United States

EMEA

EUROPE MIDDLE EAST AND AFRICA  
Belgium, France, Germany, Israel, Italy, Norway, Romania,  
Russia, Saudi Arabia, Spain, Turkey, United Kingdom

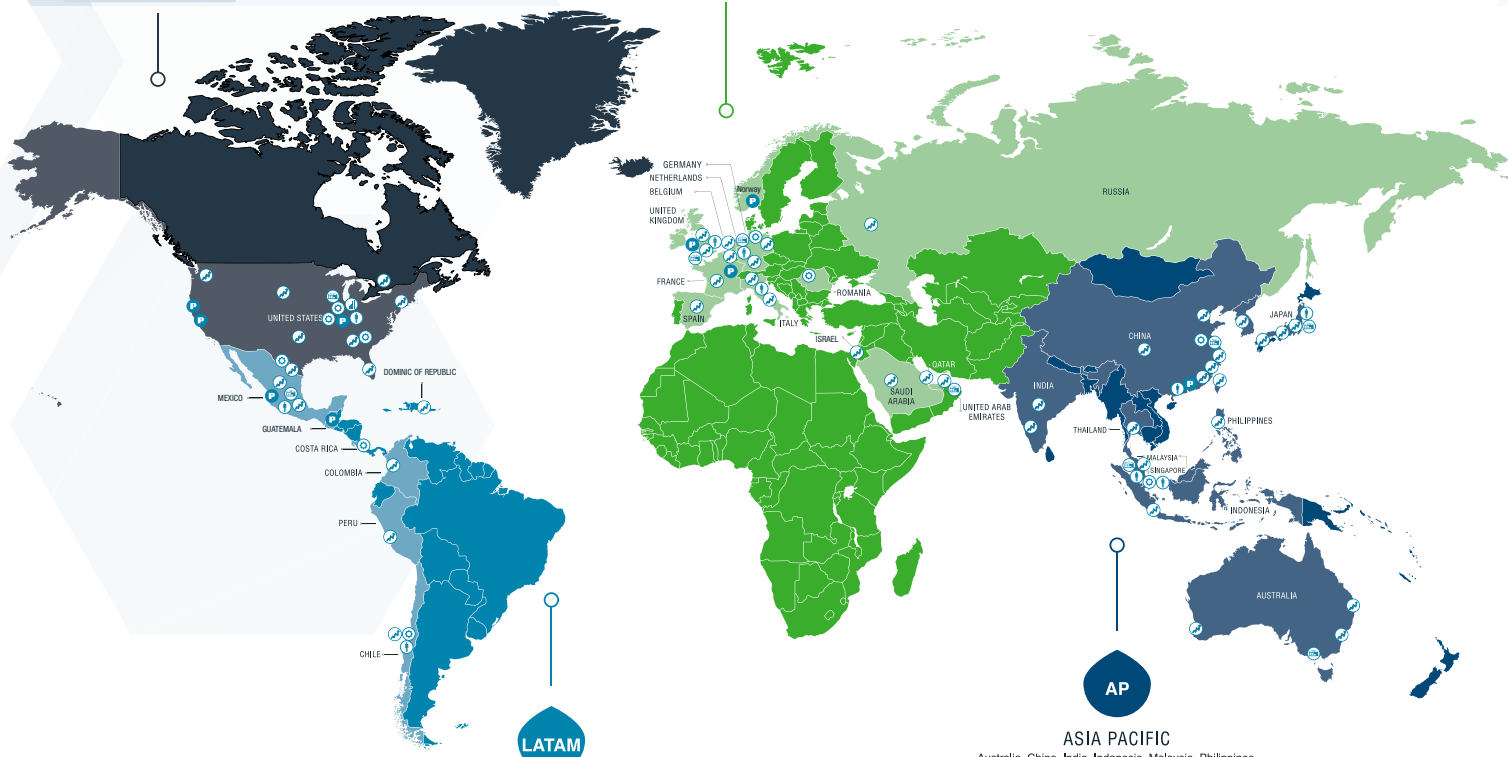

LATAM

LATIN AMERICA  
Chile, Columbia, Costa Rica, Dominic of Republic,  
Guatemala, Mexico, Peru

AP

ASIA PACIFIC  
Australia, China, India, Indonesia, Malaysia, Philippines,  
Singapore, Thailand

The information contained in this catalog is intended as a guide for use by persons having technical skill at their own discretion and risk. Before using any Panduit product, the buyer must determine the suitability of the product for his/her intended use and buyer assumes all risk and liability whatsoever in connection therewith. Panduit disclaims any liability arising from any Information contained herein or for absence of the same.

All Panduit products are subject to the terms, conditions and limitation of its then current Limited Product Warranty, which can be found at [www.panduit.com/warranty](http://www.panduit.com/warranty).

The logo for Panduit Corp. features the word "PANDUIT" in a bold, white, sans-serif font. The letter "P" is significantly larger and more prominent than the other letters, which are of uniform size. A registered trademark symbol (®) is located at the top right of the word.

**Panduit Corp.**  
**World Headquarters**  
**Tinley Park, IL 60487**

**800.777.3300**

**[www.panduit.com](http://www.panduit.com)**